

PowerFlex Low Voltage Drives Selection Guide



Powerful Performance. Flexible Control.



LISTEN.
THINK.
SOLVE.®

PowerFlex Low Voltage Drives

Selection Guide



Drive Benefits that Make a Difference	2
PowerFlex 520-Series Drives Overview	10
PowerFlex 750-Series Drives Overview	12
PowerFlex 755T Drives Overview	14
PowerFlex® Drives At-a-Glance	16
PowerFlex Drives Selection	
PowerFlex 4M	21
PowerFlex 400	24
PowerFlex 4	28
PowerFlex 40	28
PowerFlex 40P	29
PowerFlex 4-Class Options	30
PowerFlex 523	37
PowerFlex 525	41
PowerFlex 527	45
PowerFlex 520-Series Options	49
PowerFlex 70	57
PowerFlex 700	65
PowerFlex 700S	65
PowerFlex 700L	65
PowerFlex 753	66
PowerFlex 755	82
PowerFlex 755TL and 755TR	118
PowerFlex 7-Class Options	126
PowerFlex DC	148
PowerFlex DC Options	152
PowerFlex Drives Detailed Comparison Charts	164
Glossary	169
Line and Load Options	171
Tools and Resources	172
Rockwell Automation Services and Support	173



PowerFlex Drives

PowerFlex Drives help provide added benefits that make a difference for your bottom line

The Allen-Bradley® PowerFlex family of AC and DC drives has been developed to provide the benefits that matter most to you. Our focus on delivering a flexible portfolio designed to keep you connected to your operations and ultimately help improve productivity, helps you achieve the positive impact you need to be successful.

Flexibility allows PowerFlex drives to meet a wide variety of application requirements.

- A broad range of motor control algorithms to handle the simplest to the most demanding applications
- A wide selection of hardware, software, safety and packaging options to fit your application

Connectivity is a key to monitoring your application and taking the appropriate actions to maintain smooth operations. The seamless flow of real-time information within your application can help to enhance the agility and productivity of your machine.

- Seamless visibility and communications between the plant floor and control room
- Communication choices include drives with built-in EtherNet/IP along with options that support a variety of industrial networks
- Access to real time data allows information-enabled decisions to keep production running smoothly

Productivity is built into every PowerFlex drive.

- Safety features help protect personnel and assets while enabling reduced downtime after a safety event
- Premier Integration into the Logix environment streamlines configuration and programming
- Protect against unplanned downtime with advanced diagnostics

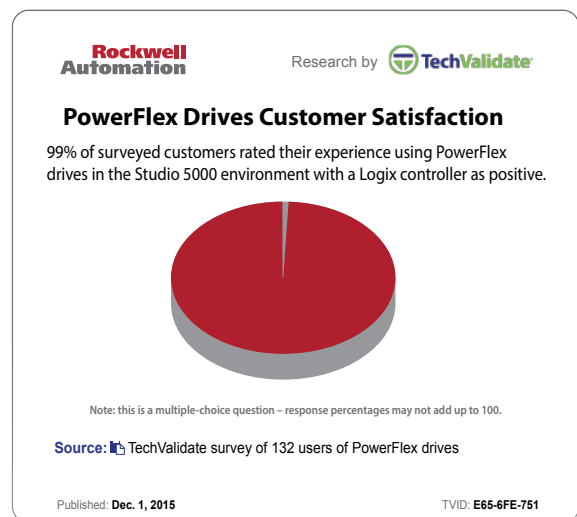

Drive Efficient Operations

Efficiency translates to savings. Motors typically consume as much as 60% of the energy in an industrial facility. Adjusting the speed of motors to exactly match the requirements of the application can help provide significant savings to your operations. PowerFlex drives are capable of providing both an immediate and measurable impact on energy use and operational productivity.

- Some PowerFlex drives offer an **Economizer mode** which consists of sensorless vector control with an additional energy savings function. When steady-state speed is achieved, the economizer becomes active and automatically adjusts the drive output voltage based on the applied load. Matching the output voltage to the applied load helps optimize motor efficiency.
- The option for **permanent magnet motor control** is available with many PowerFlex drives. Using permanent magnet motors can help improve energy efficiency and reduce related costs. The higher power density provided by permanent magnet motors often results in a motor size reduction while maintaining the same output torque.
- PowerFlex drives with **regeneration capability** help reduce energy consumption by delivering regenerative energy from motors back to the incoming power supply.

Specific Application Control

Select PowerFlex drives have specialized drive parameters configured to support a particular application. Application Sets are a configuration of the standard drive parameters designed to simplify a user's implementation of a standard drive application without the need for custom programming.

TorqProve™ – This feature helps confirm control of the load in lifting and hoisting applications.

DeviceLogix™ is an embedded control technology in PowerFlex 753 and PowerFlex 755 drives that can control outputs and manage status information onboard the drive.

AppView® – Simplifies configuration of PowerFlex 523 and 525 drives by providing parameter groups for common applications including conveyors, mixers, pumps and blowers.

CustomView™ – Reduce future design time by quickly defining your own group of parameters for PowerFlex 523 and 525 drives.

See glossary on page 169 for more details.

Motor Control Optimization

Optimize your application with a wide range of control technologies from open loop speed regulation to precise torque and speed control. In addition to industry standard motor control, the PowerFlex family offers unique control technologies that can provide you with even greater application flexibility.

- **FORCE™ Technology**, is the original Allen-Bradley patented Field Oriented Control, that provides excellent low speed/zero speed performance and delivers accurate torque and speed regulation.
- PowerFlex 755T drives are the first to offer **TotalFORCE™ Technology** which builds on the original FORCE technology to deliver superior motor control through precise, adaptive control of velocity, torque and position for electric motors. TotalFORCE Technology incorporates several patented features that are designed to help optimize your system and maintain productivity.



Access Real-time Information

Getting valuable **real-time data** from your application can help enhance the productivity of your business.

As part of the Rockwell Automation® Integrated Architecture®, PowerFlex drives can do much more than just respond to interlocking commands. They provide valuable **diagnostic information** and can be configured as a natural extension of the system.

EtherNet/IP connectivity supports seamless integration into the Logix environment. PowerFlex drives help you apply this open, widely adopted network by making connections simple with built-in or optional EtherNet/IP communication ports.

EtherNet/IP connectivity provides the flexibility to support multiple network topologies – linear, star, or ring configurations. An added advantage is the support for device level ring (DLR) functionality. Implementing a DLR system, helps you achieve higher network resiliency. If one device on the EtherNet/IP network fails, communication is rerouted allowing the devices to continue operation.

In addition to EtherNet/IP, PowerFlex drives are capable of supporting industrial communication protocols found throughout the world. See the drive options for more details.

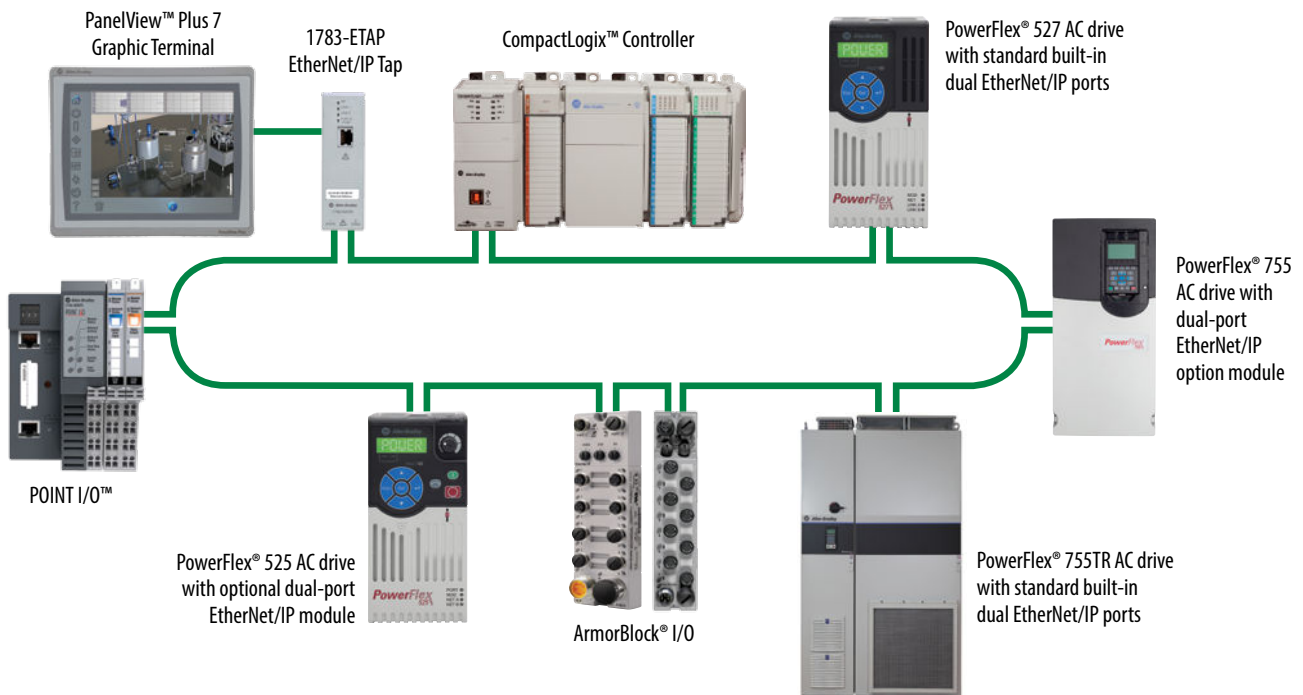

A DLR system helps you achieve higher network resiliency. If one device on the EtherNet/IP network fails, communication is rerouted, allowing the devices to continue operation.

Simplified Drive Configuration and Programming

PowerFlex drives help make configuration and programming fast and uncomplicated with a choice of easy-to-use software packages and tools. Each tool has been designed to be powerful and intuitive to help enhance your user experience and reduce your development time so you can deliver machines faster and more efficiently.

Human Interface Module

The Human Interface Module (HIM) provides convenient configuration.

- Features a high definition LCD
- Supports multiple languages
- Provides meaningful explanations of parameters and events so you don't have to search through a manual for details
- Available with most PowerFlex drives. Refer to specific drive details

Connected Components Workbench Software

Connected Components Workbench™ programming and configuration software leverages proven Rockwell Automation and Microsoft® Visual Studio® technologies for fast and easy drive configuration, controller programming, and integration with the HMI editor.

- Free software helps you get your drives up and running with an intuitive interface and startup wizards
- Localized language support
- Online and offline configuration
- Context-sensitive "Help"
- Supports PowerFlex drives as well as Micro800® programmable controllers and PanelView component graphic terminals

Configuration and Programming with Studio 5000 Logix Designer

PowerFlex drives are able to achieve an exceptional level of integration with Logix Programmable Automation Controllers (PACs) within the Studio 5000® environment.

- Data associated with the drive is automatically generated to ease configuration and minimize the need to manually program the required parameters and tags
- Increase productivity with easy access to system and machine level data as well as diagnostic information

The PowerFlex 527 and 755 AC drives can be programmed using motion instructions in the Studio 5000 environment. These motion instructions are shared with Kinetix® servo drives, providing a common configuration, programming and control experience for both types of drives.

- Consistent configuration of AC and servo drives simplifies machine development and use
- The use of motion instructions allows code reuse which helps make machine design more efficient
- Synchronization of drives and other EtherNet/IP compliant devices helps enhance performance for applications that require high accuracy

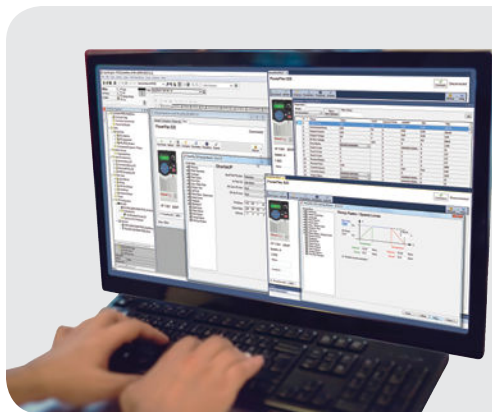

Configuring PowerFlex drives with the Studio 5000 Logix Designer® application lets you consolidate controller programming and drive system configuration, operation, and maintenance into a single software environment.



Drive Integration with Studio 5000

The Rockwell Automation Integrated Architecture system provides a convergence of control and information to help you achieve plantwide optimization. At the heart of an automated control system, the Studio 5000 environment serves as a single programming tool for the design and configuration of your application. You need only one software package for discrete, process, batch, safety and drive-based applications.

Save Configuration Time with Premier Integration

Premier Integration is the exclusive experience of integrating Allen-Bradley motor control devices into the Allen-Bradley Logix control platform. Use just one software tool to help reduce your programming time, ease startup and commissioning and streamline diagnostics.

- Single development environment to configure and program your entire control and device system
- Drive configuration is saved as part of the Studio 5000 Logix Designer project file and stored in the Logix controller. You only need one file for both the controller and all drive configurations
- Consolidating controller programming and device system configuration helps reduce complication and eliminates mismatch errors
- Diagnostic, fault, alarm and event information are integral to the Studio 5000 environment

Studio 5000 software can help reduce programming time by automatically populating drive parameters in the controller memory as controller tags.

- Descriptive tag names are automatically generated
- Address mismatch errors can be eliminated
- Copy and paste function makes duplicating drives fast and easy
- Advanced graphical wizards walk you through drive configuration

When functioning as part of a Logix control system, PowerFlex drives can do much more than just respond to interlocking commands.

- Predict mechanical problems and help improve performance with diagnostics and real-time data
- Monitor performance either locally or remotely to make informed decisions about your assets

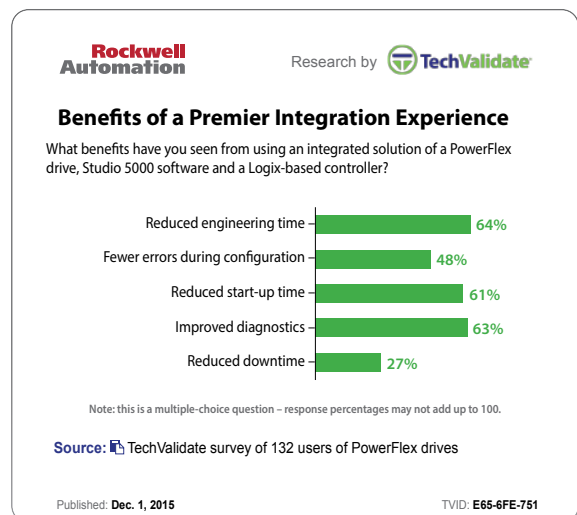

Find the latest firmware at: www.rockwellautomation.com/global/support/pcdc.page

Simplify Machine Programming and Use

To further simplify your drive and controller set up, you can use Studio 5000 motion instructions which allow you to speed the programming of your PowerFlex 527 and PowerFlex 755 drives.

The ability to configure and program both variable frequency drives and servo drives using the same motion instructions in the Studio 5000 environment has some obvious benefits. For customers using both PowerFlex AC drives and Kinetix servo drives, you gain a common user experience that can help reduce complexity and save valuable engineering time.

The use of the Studio 5000 Logix Designer motion instructions allow the PowerFlex 527 and PowerFlex 755 drives to perform as a natural extension of the controller. This level of integration provides exclusive application resources that offer additional time-saving features and performance enhancements.

- The use of motion instructions allows code reuse which helps make machine design more efficient
- Powerful diagnostics, including time stamped events, provide precise drive information to help you quickly identify and resolve problems
- With the use of motion instructions, the Logix controller maintains every aspect of the drive's parameters, and resets them each time it connects to the drive. This creates inherent automatic device replacement to help minimize machine downtime
- Synchronization – from very simple electronic gearing to electronic camming – can be accomplished using just a few instructions. Synchronization can be done over the network without the need for any additional hardware devices
- PowerFlex 527 drives exclusively use Studio 5000 software and Logix programmable automation controllers for operation
- PowerFlex 755 drives offer the option to use motions instructions in the Studio 5000 environment

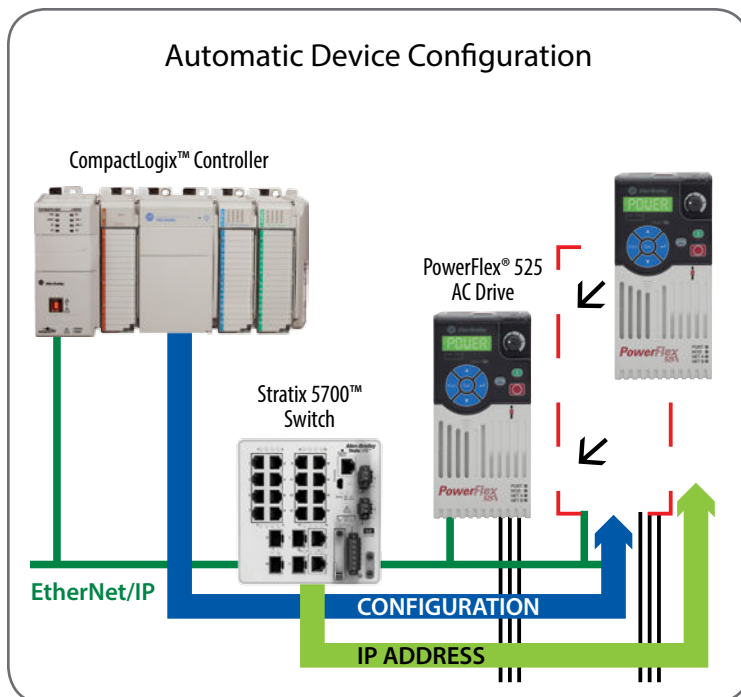
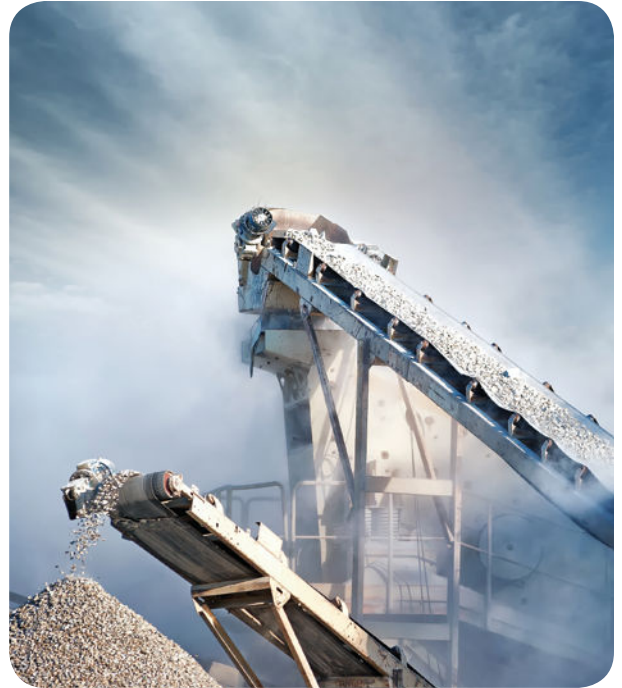

Automatic Device Configuration

Automatic device configuration (ADC) allows Logix controllers to detect a replaced PowerFlex drive and download all configuration parameters automatically, minimizing the need for manual reconfiguration. This feature helps to enhance productivity by facilitating reduced downtime.

ADC can be used with PowerFlex drives that have a standard built-in EtherNet/IP port or drives using a dual-port EtherNet/IP option.

Safety Solutions Help Improve Productivity

In the past, implementing safety solutions often meant sacrificing productivity. PowerFlex drives address productivity concerns by offering safety options that help protect your people and equipment while also reducing unplanned downtime.

Safety can be implemented with PowerFlex drives using either built-in features or add-on safety options. Choose from a hardwired configuration that is wired directly into the drive. Or use networked safety that is delivered via EtherNet/IP with select drives.

Safe Torque Off is ideal for safety-related applications that benefit from removal of rotational power to the motor without removing power from the drive. This functionality offers the benefit of quick start-up after a demand on the safety system. It provides safety ratings up to and including SIL3, PLe and CAT 3.

Safe Speed Monitor provides a solution for applications that can benefit from access to a safety zone while there is limited motion. It allows operators to perform some process or maintenance work without stopping the machine. This option carries a safety rating up to and including SIL3, PLe and CAT 4.

Look to the portfolio of Allen-Bradley safety solutions to help achieve your safety needs.

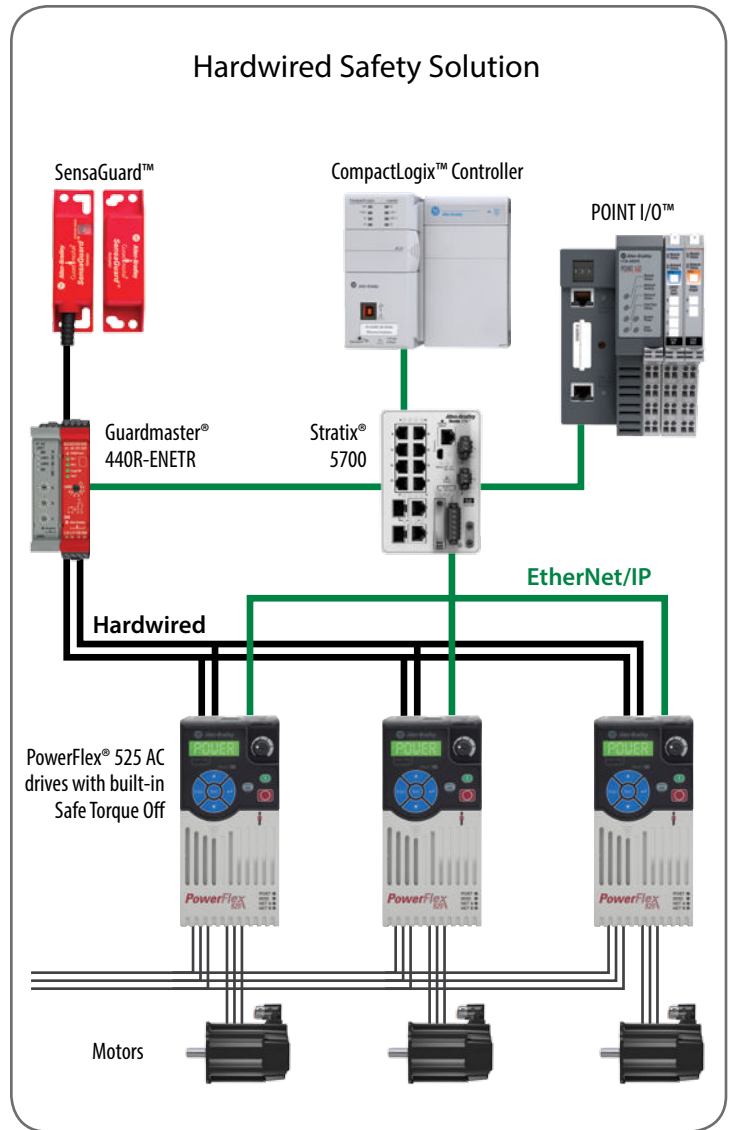

	Hardwired Safe Torque Off	Networked Safe Torque Off	Safe Speed Monitor
PowerFlex 525 Drive	Built-in: SIL2, PLd, CAT 3	N/A	N/A
PowerFlex 527 Drive	Built-in: SIL3, PLe, CAT 3	Built-in: SIL3, PLe, CAT 3	N/A
PowerFlex 70 Drive	Option: SIL2, PLd, CAT 3	N/A	N/A
PowerFlex 753 Drive	Option: SIL3, PLe, CAT 3	N/A	Option: SIL3, PLe, CAT 4
PowerFlex 755 Drive	Option: SIL3, PLe, CAT 3	Option: SIL3, PLe, CAT 3	Option: SIL3, PLe, CAT 4
PowerFlex 755TL Drive	Option: SIL3, PLe, CAT 3	Option: SIL3, PLe, CAT 3	Option: SIL3, PLe, CAT 4
PowerFlex 755TR Drive	Option: SIL3, PLe, CAT 3	Option: SIL3, PLe, CAT 3	Option: SIL3, PLe, CAT 4
PowerFlex 755TM Drive	Option: SIL3, PLe, CAT 3	Option: SIL3, PLe, CAT 3	Option: SIL3, PLe, CAT 4

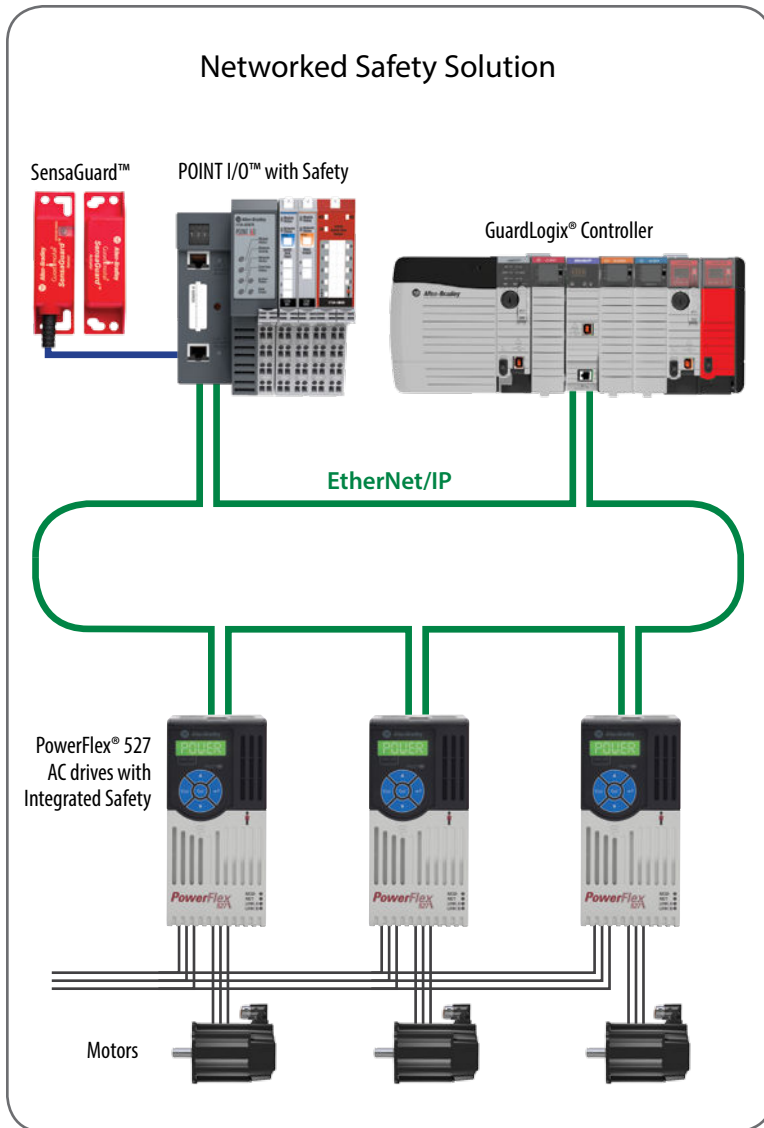

Networked Safety Helps Streamline Machine Design

Benefit from the ability to integrate safety into your control system. Networked Safe Torque Off provides the same benefits as hardwired Safe Torque Off – plus the ability to simplify your machine design and minimize equipment redundancies.

- A single GuardLogix controller can be used for both safety and standard control
- Reduce the need to write and coordinate multiple programs on different controllers, to simplify application programming and reduce training and support costs
- Fewer components mean smaller panel enclosures, saving money on control cabinets and floor space
- The integration of the safety and standard control systems provides operators and maintenance personnel with visibility to all machine events – including safety events. This enables a quick response that allows the machine to return to full production
- Safety and non-safety functions share the same EtherNet/IP network
- More safety tags are seen in controller
 - Safe off condition
 - Safety fault condition
 - Connection status
 - Reset Requirement
- Standard feature for PowerFlex 527 drives
- Option for PowerFlex 755, 755TL, 755TR and 755TM drives. See page 13 for details

Networked Safety Gives You Zone Control

In the past, a safety event in one section of a machine could result in the entire machine shutting down because the standard system had limited knowledge of the safety event. But networked safety allows the control and safety systems to coexist on the same network and to share data between the safety and standard applications. This allows “zone control” where one zone of the machine is brought to a safe state while other zones continue to operate.

- Using a networked safety solution, drives and their respective motors are grouped together into zones. All zoning is done completely in the controller – compared with a hardwired solution in which drives have safety inputs daisy chained together
- Modifications to your application are simplified which helps to save you both time and money



PowerFlex 520-Series AC Drives

The next generation of powerful performance. Flexible control.

Allen-Bradley PowerFlex 520-Series AC drives combine innovation and ease of use to provide motor control solutions designed to maximize your system performance and reduce your time to design and deliver better machines. Each of the three drives in this family offers a unique set of features to distinctively match the needs of your application.

PowerFlex 523 AC drives are ideal for machines that require cost-effective motor control. They are designed to help reduce installation and configuration time while providing the control your application needs.

- Standard USB port for upload/download drive configuration
- Flexible installation and sensorless vector (SVC) motor control
- Optional communication modules make it easy to add drive to a network

PowerFlex 525 AC drives are ideal for machines with simple system integration and offer standard features including Safe Torque Off and a built-in port for EtherNet/IP.

- Seamless integration into Logix control architectures along with Automatic Device Configuration
- Flexible installation and motor control options including permanent magnet motor control
- Optional communication modules make it easy to add drive to a network



PowerFlex 527 AC drives are designed to be used with an Allen-Bradley Logix Programmable Automation Controller (PAC). Ideal for machines that can benefit from the same drive configuration experience for both servo and AC drives, this new approach to motor control helps to reduce engineering time and enhance motor coordination for improved machine performance.

- Safe Torque Off feature can be hardwired or deployed over the EtherNet/IP network
- Built-in dual-port EtherNet/IP supports multiple network topologies and Device Level Ring functionality
- For applications that require both simple speed control as well as precise motor functionality, a combination of AC and servo drives is the logical solution. The PowerFlex 527 AC drive can manage the simple speed control while a Kinetix servo drive handles the more precise motor control operations involving speed, torque and position control



Simplified Programming – MainsFree™ programming allows configuration files to be uploaded and downloaded to the PowerFlex 525 and PowerFlex 523 drive control module via a USB connection.



High Operating Temperature – A control module fan kit allows PowerFlex 520-Series AC drives to run in temperatures up to 70 °C (158 °F) with current derating.



Innovative Design – The modular design helps reduce spare parts inventory and provides a faster way to install and configure drives.



Flexibility – All PowerFlex 520-Series drives can be installed vertically or horizontally as well as side by side in either orientation. A control module fan kit is required for horizontal mounting.

PowerFlex 525 AC Drive with permanent magnet motor control helps improve energy efficiency

Our PowerFlex 525 drives now have the ability to control permanent magnet motors that can help improve energy efficiency and reduce related costs. The higher power density provided by permanent magnet motors often results in a motor size reduction while maintaining the same output torque.

- Greater efficiency with permanent magnet motors helps you reduce energy costs
- Both interior mount (open and closed loop) and surface mount (open loop) permanent magnet motors are supported
- No new drive hardware is required

Use of permanent magnet motors requires version 5 firmware for the drive.

The firmware and release notes can be found in the [Product Compatibility and Download Center](#).

PowerFlex 523 drive configurable analog output provides more functionality

Our PowerFlex 523 drives now come with one configurable analog output. This new hardware capability is ideal for drives that are used in standalone applications. The analog output can be used to communicate a reference point to another drive or external device. This functionality provides a simple and low-cost solution for monitoring the machine.

Use of analog output requires series B hardware and version 3 firmware. The firmware and release notes can be found in the [Product Compatibility and Download Center](#).



PowerFlex 750-Series AC Drives

Bringing flexibility, connectivity and productivity to your application

The PowerFlex 753 and 755 AC drives were designed with your needs in mind. Your need for flexibility, connectivity and productivity has been considered in every detail of these drives. The result is a series of AC drives that provides an exceptional user experience, from initial programming through operation and maintenance. Offering more selection for control, communications, safety and supporting hardware options than any other drives in their class, PowerFlex 750-Series AC drives provide the features you need to help maximize your productivity.

PowerFlex 753 AC drives are cost-effective and easy to use for more general purpose applications. They feature standard built-in I/O plus three options slots for communications, safety and additional I/O. Designed to meet your application requirements for speed and torque control up to 270 kW/400 Hp.

- Embedded I/O along with three option slots for safety, feedback, communications, 24V power or additional I/O make the drive a flexible, cost-effective solution
- Safe Torque Off and Safe Speed Monitor options help to protect personnel and assets while reducing downtime

PowerFlex 755 AC drives provide ease of use, application flexibility and high performance. They include multiple control, hardware, and safety options. These drives are well-suited for a wide variety of applications with multiple motor control selections. Built-in EtherNet/IP delivers real time operating data and easily integrates into the Logix control system. Ideal for applications requiring position, speed or torque control up to 1500 kW/2000 Hp.

- Seamless integration into Logix control architectures along with ADC
- Built-in single port EtherNet/IP plus five option slots to support additional options for feedback, I/O, safety, communications and auxiliary 24V DC control power
- Safety options include hardwired or networked Safe Torque Off and hardwired Safe Speed Monitor
- Ideal for coordinated drive systems applications, positioning applications and lifting applications (TorqProve)
- DeviceLogix to complement system programming capabilities
- Option to use motion instructions within Studio 5000 to help reduce engineering time for applications using both AC and servo drives



Communications – The PowerFlex 750-Series AC drives support a comprehensive range of network protocols to ease integration into your architecture.

Safe Torque Off and Safe Speed Monitor – Help protect personnel and equipment while reducing machine downtime with safety solutions up to and including PLe/SIL3, CAT 3 and CAT 4.

Power and Packaging – Complete power range of 0.75 to 1500 kW (1 to 2000 Hp) plus 400/480 and 600/690 volt availability for global applications. Packaging options are available to meet a variety of application environmental conditions.

Predictive Diagnostics – Help reduce unplanned downtime with predictive diagnostics and built-in protection features designed to guard your investment.

Configure for Your Application – The drives have a slot-based hardware architecture that gives you the flexibility to select up to five option cards to suit your application and expand your drive for future needs.



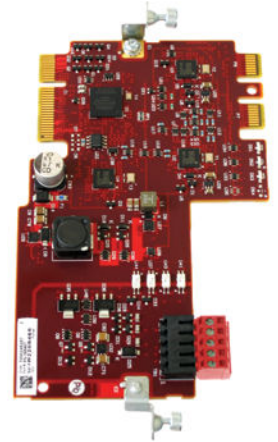

Networked Safe Torque Off option module

A new safety option card provides Safe Torque Off functionality via a built-in EtherNet/IP port for the PowerFlex 755, PowerFlex 755TL, PowerFlex 755TR and PowerFlex 755TM drives. The ability to integrate the safety functions over EtherNet/IP provides the opportunity to reduce hardware and installation costs while improving productivity. The Safe Torque Off option module has a SIL3, PLe, CAT 3 rating and helps to reduce wiring and panel footprint.

For flexibility and simplified machine design changes, the option module can be used for both hardwired and networked Safe Torque Off applications. Refer to page 129 for system requirements.

PowerFlex 750-Series AC Drives in 200/240 voltages

The PowerFlex 753 and PowerFlex 755 AC drives are expanding their voltage range to include 200/240 volt drives. The global voltages from 200V to 690V allow the drives to be used in a broader range of applications. The new 200/240V drives have a power range of 0.37...132 kW / 0.5...200 Hp and availability in mid-2017.

PowerFlex 755 Drive offers enhanced capabilities

PowerFlex 755 drives have expanded use of motion instructions within the Studio 5000 environment.

- Allows drive I/O capabilities to be accessed through the Logix controller
 - Use of pre-configured I/O helps reduce start-up time.
Pre-configured I/O include:
 - Positive/negative overtravel inputs
 - Motor thermostat input (22-Series I/O card)
 - Pre-charge input
 - Brake output
 - Regeneration OK input
 - Contactor enable output
 - Availability of general-purpose analog and digital I/O provides flexibility
 - Simplifies programming – no parameters to find and use
- Extends the use of motion instructions to the TorqProve feature:
 - Helps confirm control of the load in lifting or hoisting applications to help protect personnel and assets
 - Simplifies coordination of multiple lifting, hoisting and crane systems using intrinsic motor synchronization
 - For more information on TorqProve, see the [PowerFlex Drives for Crane and Hoist Applications Brochure](#), publication PFLEX-BR009_
- Supports 24 bit feedback for high performance motor control

The new features are available with PowerFlex 755 drive firmware version 12 and Studio 5000 software version 28 or higher.



PowerFlex 755T Drive Solutions

The Next Step in Powerful Performance. Flexible Control.

Your investment is significant. The application is crucial. And improving productivity is essential. Finding the right AC drives to help optimize assets and make good use of valuable time is an important part of achieving your goals. That's why we developed the PowerFlex 755T drives. These new additions to the PowerFlex family have been built to help you save time, reduce costs and keep your machine up and running. Because a machine that's down isn't helping your productivity.

The PowerFlex 755T drives provide harmonic mitigation, regeneration and common bus solutions that help you reduce energy costs, gain flexibility and increase productivity. These are the first drives to offer TotalFORCE technology to achieve superior motor control through precise, adaptive control of velocity, torque and position for electric motors. TotalFORCE technology incorporates several patented features that are designed to help optimize your system and maintain productivity.

The new PowerFlex 755T drives include:

- **PowerFlex 755TL Drive** – Provides harmonic mitigation and power factor correction through the use of active front end technology. By reducing the adverse effects of harmonic distortion, the drive helps to improve energy efficiency, reduce energy costs and minimize power distribution issues on the factory floor.
- **PowerFlex 755TR Drive** – Features built-in regeneration capability that helps decrease energy consumption by delivering regenerative energy from motors back to the incoming supply. Line regeneration reduces the need for braking resistors and associated cooling equipment and helps avoid wasteful dissipation of energy. The drive also offers harmonic mitigation.
- **PowerFlex 755TM Drive System** – Select from a series of predesigned configurations for regenerative common bus supplies and common bus inverters to optimize your system design and power consumption. A common bus drive system offers advantages such as design flexibility, energy optimization and reduced installation costs. PowerFlex 755TM systems provide harmonic mitigation and built-in regeneration capability.

New PowerFlex 755T drives offer harmonic mitigation, regeneration and common bus solutions



*PowerFlex 755TL drive
for harmonic mitigation*



*PowerFlex 755TR drive for
regenerative solutions*



PowerFlex 755TM drive system for common bus solutions

New PowerFlex 755T drives offer harmonic mitigation, regeneration and common bus solutions and expand the proven portfolio of the PowerFlex 753 and 755 AC drives.

Designed and built using a modular approach, the new drives offer the added advantage of fast and easy installation and maintenance with simplified management of spare parts.

Optimize your productivity by taking advantage of the following key features offered in the PowerFlex 755TL, PowerFlex 755TR and PowerFlex 755TM drives with TotalFORCE technology:

- **Predictive Diagnostics and Maintenance** – Help improve productivity by monitoring drive operating conditions and calculating the remaining life span of drive components, so preventive action can be taken if necessary
- **Market-leading Power Density** – Optimized packaging of power components with options for additional built-in functionality provide efficient use of floor space
- **Harmonic Mitigation** – Drives meet the IEEE 519 standard (5% or less of total harmonic distortion)
- **Serviceability** – Designed with key components that are modular in design and easily accessible. This allows for simplified servicing and helps reduce both cost and service time
- **Roll in/out Design** – Makes the power and filter modules easy to install and service. Power wiring can stay connected while unit is rolled out
- **Patented Slot-based Hardware Structure** – Allows you to select option modules for safety, feedback, communications and I/O. Option modules can be added if and when you need them
- **Safe Torque Off and Safe Speed Monitor** – Select the safety option that best meets the needs of your application
- **Adaptive Control** – As your equipment operates, load observer and adaptive tuning monitor machine characteristics that can change over time and automatically compensate for the changes that occur
- **Voltage Boost Ride-Through** – Helps keep equipment running through power quality disturbances
- **Communications** – Built-in dual EtherNet/IP ports allow for topology flexibility and Device Level Ring functionality



A convenient service cart allows one person to easily insert or remove a module for easy installation and maintenance

Remote Monitoring & Analytics

Gaining insight into the performance of your automation machinery is the key to optimizing your operations and preventing costly downtime events. To help reduce your downtime, Rockwell Automation provides the Remote Monitoring & Analytics Service – using powerful visualization and dashboard tools coupled with a support center staffed by Rockwell Automation experts who monitor your assets in real time to help keep you operating. This service is available for PowerFlex 755T and PowerFlex 755 drives*.

- Flexible, scalable remote monitoring service collects, organizes and normalizes real-time data and provides insights through powerful visualization, analytic and dashboard tools
- A support center staffed by Rockwell Automation experts monitors the data in real time to help keep you operating at your highest
- Upon a fault or alarm, a Rockwell Automation remote support engineer contacts you to troubleshoot and resolve the issue and help get you back up and running
- The service includes capabilities such as automatic black box data capture on a failure, preventive maintenance tracking and critical diagnostic indicator tracking.

For more information about any of our services and the bundled options available, please contact your Rockwell Automation representative.

*Remote Monitoring & Analytic Services available for PowerFlex 755 floor mount drives.

PowerFlex AC Drives



	PowerFlex 4M AC Drive	PowerFlex 400 AC Drive
Motor Control	<ul style="list-style-type: none"> Volts per Hertz 	<ul style="list-style-type: none"> Volts per Hertz
Application	<ul style="list-style-type: none"> Open loop speed regulation 	<ul style="list-style-type: none"> Open loop speed regulation
Ratings 100-115V 1 Phase In/3 Phase 230V Out	<ul style="list-style-type: none"> 0.2...1.1 kW • 0.25...1.5 Hp • 1.6...6 A 	<ul style="list-style-type: none"> N/A
Ratings 200-240V	<ul style="list-style-type: none"> 0.2...7.5 kW • 0.25...10 Hp • 1.6...33 A 	<ul style="list-style-type: none"> 2.2...37 kW • 3.0...50 Hp • 12...145 A
Ratings 400-480V	<ul style="list-style-type: none"> 0.4...11 kW • 0.5...15 Hp • 1.5...24 A 	<ul style="list-style-type: none"> 2.2...250 kW • 3.0...350 Hp • 6...460 A
Ratings 500-600V	<ul style="list-style-type: none"> N/A 	<ul style="list-style-type: none"> N/A
Features	<ul style="list-style-type: none"> Compact, space saving design Most cost-effective member of the PowerFlex family of drives Feed-through wiring Ambient temperatures up to 50 °C (122 °F) permitted with minimal spacing between drives Zero Stacking™ Drives for ambient temperatures up to 40 °C (104 °F) Drive overload protection and ramp regulation Configuration and programming via HIM, Studio 5000 Logix Designer or Connected Components Workbench software 	<ul style="list-style-type: none"> Ideal for pump and fan applications Designed to meet demands for flexibility, space savings and ease-of-use Drive overload protection, flying start, purge and damper input, hand/off/auto, and sleep/wake, PID features Configuration and programming via HIM, Studio 5000 Logix Designer or Connected Components Workbench software Ambient Temperature up to 50 °C (122 °F)
Communications Options	<ul style="list-style-type: none"> Integral RS485 (Modbus RTU) Optional: *EtherNet/IP, *ControlNet, *DeviceNet, *Bluetooth®, *LonWorks®, *PROFIBUS DP <p><small>* Optional network for use only with DSI External Communications Kit</small></p>	<ul style="list-style-type: none"> Integral RS485 (Modbus RTU, Metasys N2, P1-FLN) Optional: *EtherNet/IP, *ControlNet, *DeviceNet, BACnet, *Bluetooth®, *LonWorks®, *PROFIBUS DP
Safety	<ul style="list-style-type: none"> No 	<ul style="list-style-type: none"> No
Selection Guide Page	<ul style="list-style-type: none"> Found on page 21 	<ul style="list-style-type: none"> Found on page 24

For detailed drive comparison charts, see page 164.



PowerFlex 523 AC Drive

PowerFlex 525 AC Drive

PowerFlex 527 AC Drive

- Volts per Hertz
- Sensorless vector control

- Open loop speed regulation

• 0.2...1.1 kW • 0.25...1.5 Hp • 1.6...6 A

• 0.2...15 kW • 0.25...20 Hp • 1.6...62.1 A

• 0.4...22 kW • 0.5...30 Hp • 1.4...43 A

• 0.4...22 kW • 0.5...30 Hp • 0.9...32 A

- Modular design eases installation
- Operating temperatures from -20 °C (-4 °F) up to 50 °C (122 °F). Up to 70 °C (158 °F) with current derating and optional control module fan kit
- Configuration and programming via multi-language HIM, Studio 5000 Logix Designer or Connected Components Workbench software
- Economizer motor control for energy savings
- Application specific parameter groups
- Configurable analog output communicates a reference point to another drive or external device
- Automatic Device Configuration*

* Requires Dual-port EtherNet/IP Option Module (Cat. No. 25-COMM-E2P)

- Integral RS485 (Modbus RTU)
- Optional: Dual-port EtherNet/IP, DeviceNet, PROFIBUS DP

• No

• Found on page 37

- Volts per Hertz
- Sensorless vector control
- Closed loop velocity vector control
- Permanent magnet motor control

- Open loop speed regulation
- Closed loop speed regulation

• 0.4...1.1 kW • 0.5...1.5 Hp • 2.5...6 A

• 0.4...15 kW • 0.5...20 Hp • 2.5...62.1 A

• 0.4...22 kW • 0.5...30 Hp • 1.4...43 A

• 0.4...22 kW • 0.5...30 Hp • 0.9...32 A

- Modular design eases installation
- Operating temperatures from -20 °C (-4 °F) up to 50 °C (122 °F). Up to 70 °C (158 °F) with current derating and optional control module fan kit
- Configuration and programming via multi-language HIM, Studio 5000 Logix Designer or Connected Components Workbench software
- Economizer motor control for energy savings
- Application specific parameter groups
- Simple positioning control with optional encoder card
- Automatic Device Configuration

- Built-in EtherNet/IP port
- Integral RS485 (Modbus RTU)
- Optional: Dual-port EtherNet/IP, DeviceNet, PROFIBUS DP

• Built-in hardwired Safe Torque Off, SIL2, PLd, CAT 3

• Found on page 41

- Volts per Hertz
- Sensorless vector control
- Closed loop velocity vector control

- Open loop speed regulation
- Closed loop speed regulation

• 0.4...1.1 kW • 0.5...1.5 Hp • 2.5...6 A

• 0.4...15 kW • 0.5...20 Hp • 2.5...62.1 A

• 0.4...22 kW • 0.5...30 Hp • 1.4...43 A

• 0.4...22 kW • 0.5...30 Hp • 0.9...32 A

- Modular design eases installation
- Operating temperatures from -20 °C (-4 °F) up to 50 °C (122 °F). Up to 70 °C (158 °F) with current derating and optional control module fan kit
- Works exclusively with Logix controllers
- Configuration and programming with motion instructions in Studio 5000 Logix Designer
- Choice of hardwired or networked safety
- Removable terminal blocks help simplify installation
- Simple positioning control with optional encoder card
- Automatic Device Configuration

- Built-in dual EtherNet/IP ports

• Built-in hardwired Safe Torque Off, SIL3, PLe, CAT 3
• Built-in networked Safe Torque Off, SIL3, PLe, CAT 3

• Found on page 45

PowerFlex AC Drives



	PowerFlex 70 AC Drive	PowerFlex 753 AC Drive
Motor Control	<ul style="list-style-type: none"> Flux vector control with and without an encoder Sensorless vector control Volts per Hertz 	<ul style="list-style-type: none"> Flux vector control with and without an encoder Sensorless vector control Volts per Hertz Permanent magnet motor control
Application	<ul style="list-style-type: none"> Open loop speed regulation Closed loop speed regulation Accurate torque and speed regulation 	<ul style="list-style-type: none"> Open loop speed regulation Closed loop speed regulation Accurate torque and speed regulation Indexer positioning
Single-phase Input with Derate	<ul style="list-style-type: none"> Yes 	<ul style="list-style-type: none"> Yes
Ratings 200-240V	<ul style="list-style-type: none"> 0.37...18.5 kW • 0.5...25 Hp • 2.2...70 A 	<ul style="list-style-type: none"> 0.37...132 kW • 0.5...200 Hp • 2.2...477 A
Ratings 400-480V	<ul style="list-style-type: none"> 0.37...37 kW • 0.5...50 Hp • 1.1...72 A 	<ul style="list-style-type: none"> 0.75...270 kW • 1...400 Hp • 2.1...477 A
Ratings 500-600V	<ul style="list-style-type: none"> 0.37...37 kW • 0.5...50 Hp • 0.9...52 A 	<ul style="list-style-type: none"> 1...300 Hp • 1.7...289 A
Ratings 690V	<ul style="list-style-type: none"> N/A 	<ul style="list-style-type: none"> 7.5...250 kW • 12...263 A
Features	<ul style="list-style-type: none"> Speed and torque control with and without encoder feedback Pjump and Traverse for Fibers applications Flexible packaging and mounting Configuration and programming via HIM, Studio 5000 Logix Designer or Connected Components Workbench software 	<ul style="list-style-type: none"> Embedded I/O standard Predictive diagnostics Adjustable voltage control Three option slots for I/O, feedback, safety, auxiliary control power, communications Application-specific control for indexing, oil well and fiber applications Configuration and programming via HIM, Studio 5000 Logix Designer or Connected Components Workbench software
Communications Options	<ul style="list-style-type: none"> Internal DPI Options: Single or Dual-port EtherNet/IP, ControlNet (Coax or Fiber), DeviceNet, BACnet, CANopen, External SCANport, Interbus, LonWorks, Modbus/TCP, PROFIBUS DP, RS485 DF1, RS485 HVAC (Modbus RTU, Metasys N2, Siemens P1) 	<ul style="list-style-type: none"> Options: Single or Dual-port Ethernet/IP, ControlNet (Coax or Fiber), DeviceNet, BACnet/IP, CANopen, HVAC (Modbus RTU, FLN P1, Metasys N2), Modbus/TCP, LonWorks, PROFIBUS DP, ProfiNet IO, RS485 DFI
Safety	<ul style="list-style-type: none"> Hardwired Safe Torque Off SIL2, PLd, CAT 3 - option 	<ul style="list-style-type: none"> Hardwired Safe Torque Off SIL3, PLe, CAT 3 - option Hardwired Safe Speed Monitor SIL3, PLe, CAT 4 - option
Selection Guide Page	<ul style="list-style-type: none"> Found on page 57 	<ul style="list-style-type: none"> Found on page 66

For detailed drive comparison charts, see page 164.



PowerFlex 755 AC Drive

PowerFlex 755TL Drive

PowerFlex 755TR Drive

- Flux vector control with and without an encoder
- Sensorless vector control • Volts per Hertz
- Permanent magnet motor control

- Sensorless vector
- Volts per Hertz • Economizer
- Field oriented control
- Flux vector control

- Sensorless vector
- Volts per Hertz • Economizer
- Field oriented control
- Flux vector control

- Open loop speed regulation
- Closed loop speed regulation
- Accurate torque and speed regulation
- Accurate positioning with PCAM, indexer and gearing

- Open loop speed regulation
- Closed loop speed regulation
- Precise torque, position and speed regulation

- Open loop speed regulation
- Closed loop speed regulation
- Precise torque, position and speed regulation

- Yes (frames 1-7); No (Frames 8-10)

- No

- No

- 0.37...132 kW • 0.5...200 Hp • 2.2...477 A

- N/A

- N/A

- 0.75...1400 kW • 1...2000 Hp • 2.1...2330 A

- 160...1250 kW • 250...1800 Hp • 302...2072 A

- 160...2000 kW • 250...3000 Hp • 302...3404 A

- 1...1500 Hp • 1.7...1530 A

- 250...1500 Hp • 242...1430 A

- 250...2500 Hp • 242...2420 A

- 0.75...1500 kW • 12...1485 A

- 200...1400 kW • 215...1419 A

- 200...2300 kW • 215...2318 A

- Predictive diagnostics
- Can use motion instructions in Studio 5000 Logix Designer
- Five option slots for I/O, feedback, safety, auxiliary control power, communications
- TorqProve for lifting applications
- Application-specific control for indexing, oil well and fiber applications
- Adjustable voltage control
- Convenient roll-in/out design for floor mount drives
- Configuration and programming via HIM, Studio 5000 Logix Designer or Connected Components Workbench software

- Provides harmonic mitigation and power factor correction
- TotalFORCE technology with patented features to help optimize your system and maintain productivity
- Predictive diagnostics and maintenance
- Efficient installation and maintenance with convenient roll in/out design
- High power density with compact footprint
- TorqProve for lifting applications
- Five option slots for I/O, feedback, safety, auxiliary control power, communications
- Configuration and programming via HIM, Studio 5000 Logix Designer or Connected Components Workbench software

- Energy-efficient regenerative capability
- Provides harmonic mitigation and power factor correction
- TotalFORCE technology with patented features to help optimize your system and maintain productivity
- Predictive diagnostics and maintenance
- Efficient installation and maintenance with convenient roll in/out design
- High power density with compact footprint
- TorqProve for lifting applications
- Five option slots for I/O, feedback, safety, communications
- Configuration and programming via HIM, Studio 5000 Logix Designer or Connected Components Workbench software

- Internal DPI
- Built-in EtherNet/IP port or dual-port EtherNet/IP option
- Options: ControlNet (Coax or Fiber), DeviceNet, BACnet, CANopen, External SCANport, HVAC (Modbus RTU, FLN P1, Metasys N2), LonWorks, Modbus/TCP RS485 DF1, RS485 DFI, ProfiNet IO

- Internal DPI
- Built-in dual EtherNet/IP ports
- Options: ControlNet, DeviceNet, PROFIBUS DP, PROFINET

- Internal DPI
- Built-in dual EtherNet/IP ports
- Options: ControlNet, DeviceNet, PROFIBUS DP, PROFINET

- Hardwired Safe Torque Off SIL3, PLe, CAT 3 - option
- Networked Safe Torque Off SIL3, PLe, CAT 3 - option
- Hardwired Safe Speed Monitor SIL3, PLe, CAT 4 - option

- Hardwired Safe Torque Off SIL3, PLe, CAT 3 - option
- Networked Safe Torque Off SIL3, PLe, CAT 3 - option
- Hardwired Safe Speed Monitor SIL3, PLe, CAT 4 - option

- Hardwired Safe Torque Off SIL3, PLe, CAT 3 - option
- Networked Safe Torque Off SIL3, PLe, CAT 3 - option
- Hardwired Safe Speed Monitor SIL3, PLe, CAT 4 - option

- Found on page 82

- Found on page 118

- Found on page 118

PowerFlex AC and DC Drives



PowerFlex 755TM AC Drive

PowerFlex DC Drive

Motor Control	<ul style="list-style-type: none"> • Sensorless vector • Volts per Hertz • Economizer • Field oriented control • Flux vector control 	<ul style="list-style-type: none"> • Regenerative and Non-regenerative • Field weakening and Economize
Application Performance	<ul style="list-style-type: none"> • Open loop speed regulation • Closed loop speed regulation • Precise torque, position and speed regulation 	<ul style="list-style-type: none"> • Open loop speed regulation • Closed loop speed regulation • Torque regulation
Ratings 200-240V	<ul style="list-style-type: none"> • N/A 	<ul style="list-style-type: none"> • 1.2...224 kW • 1.5...300 Hp • 7...1050 A
Ratings 400-480V	<p>Common Bus Inverter:</p> <ul style="list-style-type: none"> • 160...2000 kW • 302...3542 A @400V • 250...3000 Hp • 302...3404 A @480V <p>Regenerative Bus Supplies:</p> <ul style="list-style-type: none"> • 188...2204 kW • 324...3801 A @400V • 216...2436 kW • 311...3501 A @480V 	<ul style="list-style-type: none"> • 1.5...671 kW • 2...900 Hp • 4.1...1494 A
Ratings 500-600V	<p>Common Bus Inverter:</p> <ul style="list-style-type: none"> • 250...2500 Hp • 242...2420 A @ 600V <p>Regenerative Bus:</p> <ul style="list-style-type: none"> • 217...2164 kW • 249...2489 A @ 600V 	<ul style="list-style-type: none"> • 37...932 kW • 50...1250 Hp • 67.5...1688 A
Ratings 690V	<p>Common Bus Inverter:</p> <ul style="list-style-type: none"> • 200...2300 kW • 215...2318 A <p>Regenerative Bus Supplies:</p> <ul style="list-style-type: none"> • 221...2379 kW • 221...2379 A 	<ul style="list-style-type: none"> • 298...1044 kW • 400...1400 Hp • 452...1582 A
Features	<ul style="list-style-type: none"> • Common bus drive system helps provide design flexibility, minimize floor space and reduce installation costs • Provides harmonic mitigation, power factor correction and regenerative capability • TotalFORCE technology with patented features helps optimize your system and maintain productivity • Predictive diagnostics and maintenance • Designed to enable coordination of multiple motors • High power density with compact footprint • TorqProve for lifting applications • Five option slots for I/O, feedback, safety, communications 	<ul style="list-style-type: none"> • Includes an armature converter, regulated field converter for field weakening or economy applications, an advanced regulator with integrated DPI functionality, DC tachometer and encoder capability. • Overload protection • PID control (speed or torque) • Adaptive gain, droop, feedback loss switchover • TorqProve for lifting applications • I/O expansion boards – option • Resolver feedback – option • Configuration and programming via HIM, Studio 5000 Logix Designer or Connected Components Workbench software
Communications	<ul style="list-style-type: none"> • Internal DPI • Built-in dual EtherNet/IP ports • Options: ControlNet, DeviceNet, PROFIBUS DP, PROFINET 	<ul style="list-style-type: none"> • Internal DPI • Options: Single or Dual-port EtherNet/IP, ControlNet (Coax or Fiber), DeviceNet, BACnet, Modbus, HVAC, PROFIBUS DP, RS485 DF1
Safety	<ul style="list-style-type: none"> • Hardwired Safe Torque Off SIL3, PLe, CAT 3 - option • Networked Safe Torque Off SIL3, PLe, CAT 3 - option • Hardwired Safe Speed Monitor SIL3, PLe, CAT 4 - option 	<ul style="list-style-type: none"> • No
Selection Guide Page	<ul style="list-style-type: none"> • See Common DC Bus Selection Guide, pub DRIVES-SG001 	<ul style="list-style-type: none"> • Found on page 148

PowerFlex 4M AC Drive

0.2...11 kW/0.25...15 Hp in voltages from 100...480V

Providing users with motor speed control in a compact, space-saving design, the PowerFlex 4M AC drive is the smallest and most cost-effective member of the PowerFlex family of drives.

Providing application flexibility, feed-through wiring and ease-of-programming, this drive is ideal for machine-level speed control for applications that require space-saving and easy-to-use AC drives.

PowerFlex 4M at a Glance

Ratings	
100...120V	0.2...1 kW/0.25...1.5 Hp/1.6...6 A
200...240V	0.2...7.5 kW/0.25...10 Hp/1.6...33 A
380...480V	0.2...11 kW/0.25...15 Hp/1.6...24 A
Motor Control	V/Hz Control
Enclosures	IP20, NEMA/UL Type Open
Certifications	<ul style="list-style-type: none"> • cULus • CE • EAC • KCC • RCM • RoHS
Options	See pages 30...36



- 1** Feed-through wiring design for simple retrofitting into applications that require variable speed motor control.
- 2** Integral keypad included. NEMA/UL Type 4X remote and Type 1 handheld keypads are available. See page 30.
- 3** Communications: Integral RS-485. See page 31 for other options.
- 4** Embedded I/O: 5 digital inputs, 1 relay output, 1 analog input, and 1 PTC input.
- 5** Internal brake IGBT in Frame C drives. See page 36 for brake resistors.

Branch circuit protection supplied separately

Isolation Transformers and Input Line Reactors are available. See pages 35...36.

External EMC filter is optional (see page 33). Integral filter is included with 240V, single-phase and 380V, three-phase drives.

Feed-through Wiring Design



DIN Rail Mounting (Frames A...B)

Output Reactors, Terminators and Reflected Wave Devices are optional. See pages 30...36.

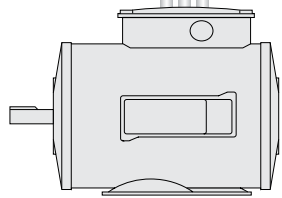

Additional Information

PowerFlex 4M Technical Data, publication [22F-TD001](#)

PowerFlex 4M User Manual, publication [22F-UM001](#)

Catalog Number Explanation

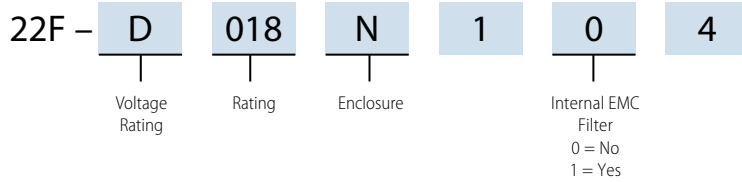

Product Selection

100...120V AC, Single-Phase Input, Three-Phase Output Drives (50/60 Hz, No Brake)

Drive Ratings				IP20, NEMA/UL Type Open	With Integral MC Filter
kW	Hp	Output Current A	Frame Size	Cat. No.	Cat. No.
0.2	0.25	1.6	A	22F-V1P6N103	—
0.4	0.5	2.5		22F-V2P5N103	
0.75	1	4.5	B	22F-V4P5N103	
1.1	1.5	6		22F-V6P0N103	

200...240V AC, Single-Phase Input, Three-Phase Output Drives (50/60 Hz, No Brake)

Drive Ratings				IP20, NEMA/UL Type Open	With Integral EMC Filter ⁽¹⁾
kW	Hp	Output Current A	Frame Size	Cat. No.	Cat. No.
0.2	0.25	1.6	A	22F-A1P6N103	22F-A1P6N113
0.4	0.5	2.5		22F-A2P5N103	22F-A2P5N113
0.75	1	4.2		22F-A4P2N103	22F-A4P2N113
1.5	2	8	B	22F-A8P0N103	22F-A8P0N113
2.2	3	11		22F-A011N103	22F-A011N113

(1) This filter is suitable for use with a cable length of up to 5 meters for class A environments and up to 1 meter for class B environments.

200...240V AC, Three-Phase Drives (50/60 Hz)

Drive Ratings				IP20, NEMA/UL Type Open	With Integral EMC Filter
kW	Hp	Output Current A	Frame Size	Cat. No.	Cat. No.
0.2	0.25	1.6	A	22F-B1P6N103	—
0.4	0.5	2.5		22F-B2P5N103	
0.75	1	4.2		22F-B4P2N103	
1.5	2	8		22F-B8P0N103	
2.2	3	12	B	22F-B012N103	
3.7	5	17.5		22F-B017N103	
With Brake					
5.5	7.5	25	C	22F-B025N104	—
7.5	10	33		22F-B033N104	

380...480V AC, Three-Phase Drives (50/60 Hz)

Drive Ratings				IP20, NEMA/UL Type Open	With Integral EMC Filter ⁽¹⁾
kW	Hp	Output Current A	Frame Size	Cat. No.	Cat. No.
0.4	0.5	1.5	A	22F-D1P5N103	22F-D1P5N113
0.75	1	2.5		22F-D2P5N103	22F-D2P5N113
1.5	2	4.2		22F-D4P2N103	22F-D4P2N113
2.2	3	6	B	22F-D6P0N103	22F-D6P0N113
3.7	5	8.7		22F-D8P7N103	22F-D8P7N113
With Brake					
5.5	7.5	13	C	22F-D013N104	22F-D013N114
7.5	10	18		22F-D018N104	22F-D018N114
11	15	24		22F-D024N104	22F-D024N114

(1) This filter is suitable for use with a cable length of up to 10 meters for Class A environments.

Approximate Dimensions and Weights

Dimensions are in mm (in.) - weights are in kg (lb)

IP20, NEMA/UL Type Open

Frame	H	W	D	Weight
A	174 (6.85)	72 (2.83)	136 (5.35)	1.58 (3.5)
B		100 (3.94)		2.09 (4.6)
C	260 (10.24)	130 (5.12)	180 (7.09)	4.81 (10.6)

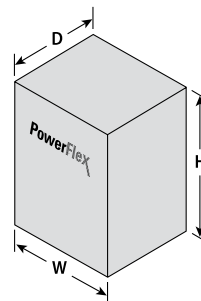

PowerFlex 400 AC Drive

2.2...250 kW/3...350 Hp in voltages from 200...480V

Providing users with easy installation and ideal for mechanical fan and pump systems, the PowerFlex 400 AC drive offers a wide range of built-in features that allow for seamless building system integration. The PowerFlex 400 is designed to meet global OEM, contractor and end-user demands for flexibility, space savings, and ease-of-use.

PowerFlex 400 at a Glance

Ratings	200...240V 380...480V	2.2...37 kW/3...50 Hp/12...145 A 2.2...250 kW/3...350 Hp/6...460 A
Motor Control	V/Hz Control	
Enclosures	<ul style="list-style-type: none"> • IP20, NEMA/UL Type Open • Flange Mount Front = IP20, NEMA/UL Type Open, Back/Heatsink = IP40/54/65, NEMA/UL Type 1/12/4/4X • IP30, NEMA/UL Type 1 (with optional kit) 	
Additional Features	PID/ PIP for fan and pump applications	
Certifications	<ul style="list-style-type: none"> • cULus • CE • EAC • KCC • RCM • RoHS 	
Options	See pages 30...36	

- 1** Integral keypad included. NEMA/UL Type 4X remote and Type 1 handheld keypads are available. See page 30.
- 2** Communications: Integral RS-485. See page 31 for other options.
- 3** Embedded I/O: 7 digital inputs, 2 relay outputs, 2 analog inputs, 1 transistor, 2 analog outputs, and 1 PTC input. Extension option available. See page 30.

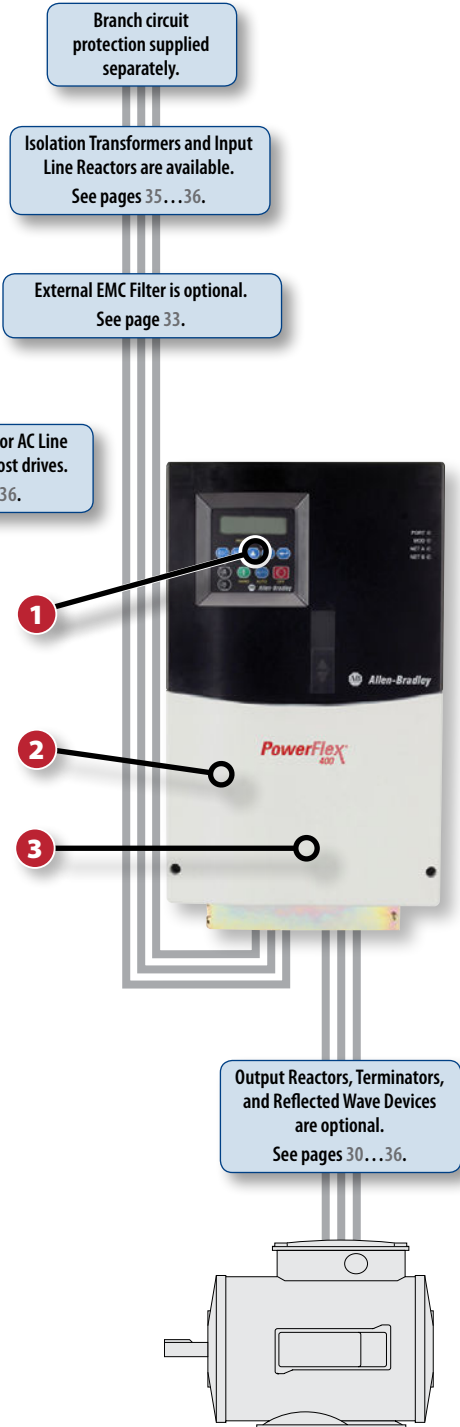

Additional Information

PowerFlex 400 Technical Data, publication [22C-TD001](#)

PowerFlex 400 User Manual, publication [22C-UM001](#)

Catalog Number Explanation

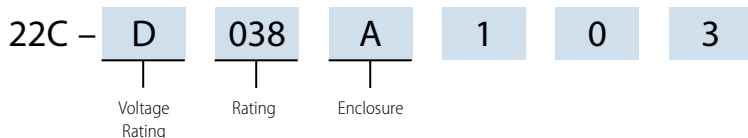

Product Selection

200...240V AC, Three-Phase Drives

Drive Ratings				Rating	Panel Mount	Flange Mount ⁽¹⁾
kW	Hp	Output Current ⁽²⁾ A	Frame Size		Cat. No.	Cat. No.
2.2	3	12	C	IP20, NEMA/UL Type Open ⁽³⁾	22C-B012N103 ⁽⁴⁾	22C-B012F103 ⁽⁴⁾
3.7	5	17.5			22C-B017N103 ⁽⁴⁾	22C-B017F103 ⁽⁴⁾
5.5	7.5	24			22C-B024N103 ⁽⁴⁾	22C-B024F103 ⁽⁴⁾
7.5	10	33			22C-B033N103 ⁽⁴⁾	22C-B033F103 ⁽⁴⁾
11	15	49	D	IP30, NEMA/UL Type 1	22C-B049A103	—
15	20	65			22C-B065A103	
18.5	25	75			22C-B075A103	
22	30	90			22C-B090A103	
30	40	120	E	22C-B120A103		
37	50	145		22C-B145A103		

(1) Front = IP20, NEMA/UL Type Open, Back/Heatsink = IP40/54/65, NEMA/UL Type 1/12/4/4X.

(2) Drive terminals are sized according to UL. Depending on operating ambient and wire used, some local or national codes may require a larger wire size than what the power terminals can accept. Multiple conductors, 90 °C (194 °F) wire, and/or lugs may be required. Refer to the PowerFlex 400 User Manual, publication [22C-UM001](#), for details on terminal block wire ranges.

(3) IP30, NEMA/UL Type 1 can be achieved for panel mount drives with top cover and optional conduit box kit installed. See page 32 for a field installed conversion kit.

(4) A DC bus inductor is not included. See page 35 for available inductors.

380...480V AC, Three-Phase Drives

Drive Ratings				Rating	Panel Mount	Flange Mount ⁽¹⁾
kW	Hp	Output Current ⁽²⁾ A	Frame Size		Cat. No.	Cat. No.
2.2	3	6	C	IP20, NEMA/UL Type Open ⁽³⁾	22C-D6P0N103 ⁽⁴⁾	22C-D6P0F103 ⁽⁴⁾
4	5	10.5			22C-D010N103 ⁽⁴⁾	22C-D010F103 ⁽⁴⁾
5.5	7.5	12			22C-D012N103 ⁽⁴⁾	22C-D012F103 ⁽⁴⁾
7.5	10	17			22C-D017N103 ⁽⁴⁾	22C-D017F103 ⁽⁴⁾
11	15	22		IP20, NEMA/UL Type Open	22C-D022N103	22C-D022F103 ⁽⁵⁾
15	20	30	22C-D030N103		22C-D030F103 ⁽⁵⁾	
18.5	25	38	D	IP30, NEMA/UL Type 1	22C-D038A103	—
22	30	45.5			22C-D045A103	
30	40	60			22C-D060A103	
37	50	72	E		22C-D072A103	
45	60	88			22C-D088A103	
55	75	105			22C-D105A103	
75	100	142			22C-D142A103	
90	125	170	F		22C-D170A103	
110	150	208			22C-D208A103	
132	200	260	G		22C-D260A103	
160	250	310		22C-D310A103		
200	300	370	H	22C-D370A103 ⁽⁶⁾		
250	350	460		22C-D460A103 ⁽⁶⁾		

(1) Front = IP20, NEMA/UL Type Open, Back/Heatsink = IP40/54/65, NEMA/UL Type 1/12/4/4X.

(2) Drive terminals are sized according to UL. Depending on operating ambient and wire used, some local or national codes may require a larger wire size than what the power terminals can accept. Multiple conductors, 90 °C wire, and/or lugs may be required. PowerFlex 400 User Manual, publication [22C-UM001](#), for details on terminal block wire ranges.

(3) IP30, NEMA/UL Type 1 can be achieved for panel mount drives with top cover and optional conduit box kit installed. See page 32 for a field installed conversion kit.

(4) A DC bus inductor is not included. See page 32 for available inductors.

(5) 11 and 15 kW (15 and 20 Hp) Frame C flange mount drives require an external DC series bus inductor.

(6) 200 and 250 kW (300 and 350 Hp) ratings include an internal AC line reactor (not a DC bus inductor).

Approximate Dimensions and Weights

Dimensions are in mm (in.) - weights are in kg (lb)

Panel Mount

Frame	H	W	D	Weight ⁽¹⁾
C	260 (10.2) 320 (12.6) ⁽²⁾	130 (5.1)	180 (7.1)	7.49 (16.5)
D	436.2 (17.17)	250 (9.84)	206.1 (8.11)	15.6 (34.4)
E	605.5 (23.84)	370 (14.57)	259.2 (10.21)	51.2 (112.9)
F	850 (33.46)	425 (16.73)	280 (11.02)	88 (194)
G	892 (35.12)	425 (16.73)	264 (10.39)	106 (233.7)
H	1363.8 (53.69)	529.2 (20.83)	358.6 (14.12)	177 (390.2)

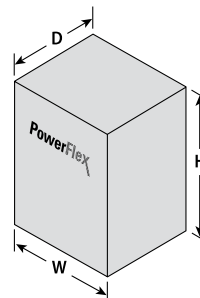

- (1) Weights are approximate. Refer to the PowerFlex 400 User Manual, publication [22C-UM001](#), for detailed weight information.
 (2) Drive with IP30, NEMA 1/UL Type 1 option kit installed.

Flange Mount

Frame	H	W	D1	D2	Weight ⁽¹⁾
C	325 (12.8)	300 (11.81)	105.8 (4.17)	138.2 (5.44)	3.85 (8.5)

- (1) Weights are approximate. Refer to the PowerFlex 400 User Manual, publication [22C-UM001](#), for detailed weight information.

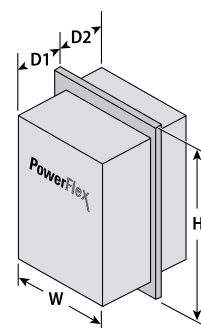

PowerFlex 4-class Drives

PowerFlex 4 AC Drive



Designed to meet global OEM and end-user demands for simplicity, space savings, and cost efficiency, this drive provides intuitive features such as an integral keypad with local potentiometer and control keys that are active right out of the box.

PowerFlex 4 AC Drive at a Glance				
Ratings	100...120V: 0.2...1.1 kW / 0.25...1.5 Hp / 1.5...6 A		200...240V: 0.2...3.7 kW / 0.25...5 Hp / 1.4...17.5 A	
	380...480V: 0.4...3.7 kW / 0.5...5 Hp / 1.4...8.7 A			
Motor Control	V/Hz Control			
Enclosures	IP20, NEMA/UL Type Open	Plate Drive Front = IP20, NEMA/UL Type Open	Flange Mount Front = IP20, NEMA/UL Type Open Back/Heatsink = IP40/54/65 NEMA/UL Type 1/12/4/4X	IP30, NEMA/UL Type 1 (with optional kit)
	IP66, NEMA/UL Type 4X			

PowerFlex 40 AC Drive



The PowerFlex 40 AC drive gives OEMs, machine builders, and end users performance-enhancing motor control in an easy to-use, compact package. The PowerFlex 40 features sensorless vector control to meet low speed torque demands that help improve application performance.

With flexible packaging options and an uncomplicated programming structure, this drive can be quickly and easily installed and configured for a variety of applications.

PowerFlex 40 AC Drive at a Glance				
Ratings	100...120V: 0.4...1.1 kW / 0.5...1.5 Hp / 2.3...6 A		200...240V: 0.4...7.5 kW / 0.5...10 Hp / 2.3...33 A	
	380...480V: 0.4...11 kW / 0.5...15 Hp / 1.4...24 A		500...600V: 0.75...11 kW / 1...15 Hp / 1.7...19 A	
Motor Control	V/Hz Control	Sensorless Vector Control		
Enclosures	IP20, NEMA/UL Type Open	Plate Drive Front = IP20, NEMA/UL Type Open	Flange Mount Front = IP20, NEMA/UL Type Open Back/Heatsink = IP40/54/65 NEMA/UL Type 1/12/4/4X	IP30, NEMA/UL Type 1 (with optional kit)
	IP66, NEMA/UL Type 4X			

PowerFlex 40P AC Drive



The PowerFlex 40P AC drive addresses user needs for closed loop control with an option for Category 3 Safe Torque Off in a compact and cost effective design. Based on the popular PowerFlex 40, this drive is designed to meet global OEM and end-user demands for flexibility, space savings, and ease of use. This drive is a cost-effective alternative for speed or basic position control of applications such as diverters, smart conveyors, packaging machines, palletizers, drafting machines, ring spinning machines, and synthetic fiber spinning machines and shares common options and accessories with the PowerFlex 40.

PowerFlex 40P AC Drive at a Glance				
Ratings	200...240V: 0.4...7.5 kW / 0.5...10 Hp / 2.3...33 A		380...480V: 0.4...11 kW / 0.5...15 Hp / 1.4...24 A	
	500...600V: 0.75...11 kW / 1...15 Hp / 1.7...19 A			
Motor Control	V/Hz Control		Sensorless Vector Control	
Enclosures	IP20, NEMA/UL Type Open		Flange Mount	IP30, NEMA/UL Type 1 (with optional kit)
			Front = IP20, NEMA/UL Type Open Back/Heatsink = IP40/54/65 NEMA/UL Type 1/12/4/4X	

For additional product selection information, please visit <http://ab.rockwellautomation.com/Drives/Low-Voltage-AC-Drives>.

PowerFlex 4-class Options

Human Interface Modules and Accessories

Description	Cat. No.	Used with PowerFlex Drive	
		4M	400
Remote (Panel Mount) LCD Display, Digital Speed Control, CopyCat Capable. Includes 2.0 meter cable. IP66, NEMA Type 4X/12 - only for indoor use.	22-HIM-C2S ⁽¹⁾	✓	✓
Remote Handheld, LCD Display, Full Numeric Keypad, Digital Speed Control, CopyCat Capable. Includes 1.0 meter cable. IP30, NEMA Type 1. Panel mount with optional Bezel Kit.	22-HIM-A3	✓	✓
Bezel Kit. Panel Mount for LCD Display, Remote Handheld Unit. IP30, NEMA Type 1. Includes a 22-RJ45CBL-C20 cable.	22-HIM-B1	✓	✓
DSI HIM Cable (DSI HIM to RJ45 cable)			
1.0 m (3.3 ft)	22-HIM-H10	✓	✓
2.9 m (9.5 ft)	22-HIM-H30	✓	✓

(1) The 22-HIM-C2S is smaller than the 22-HIM-C2 and cannot be used as a direct replacement.

Other Options

Description	Cat. No.	Used with PowerFlex Drive	
		4M	400
Auxiliary Relay Board - Expands drive output capabilities - for only Frames D...H.	AK-U9-RLB1	—	✓

Terminators

Description ⁽¹⁾	Cat. No.	Used with PowerFlex Drive	
		4M	400
For use with 3.7 kW (5 Hp) and below drives	1204-TFA1	✓	✓
For use with 1.5 kW (2 Hp) and up drives	1204-TFB2	✓	✓

(1) For selection information, refer to Appendix A of the Wiring and Grounding Guidelines for Pulse Width Modulated (PWM) AC Drives, publication [DRIVES-IN001](#).

Reflected Wave Reduction Module with Common Mode Choke

Description ⁽¹⁾	Cat. No.	Used with PowerFlex Drive	
		4M	400
17A with Common Mode Choke	1204-RWC-17-A	✓	✓

(1) For selection information, refer to Appendix A of the Wiring and Grounding Guidelines for Pulse Width Modulated (PWM) AC Drives, publication [DRIVES-IN001](#).

Reflected Wave Reduction Modules

Voltage	ND kW	ND Hp	Cat. No.	Used with PowerFlex Drive	
				4M	400
380...480V AC	2.2...4	3...5	1321-RWR8-DP	✓	✓
	4	5	1321-RWR12-DP	✓	✓
	5.5	7.5	1321-RWR18-DP	✓	✓
	7.5	10	1321-RWR25-DP	✓	✓
	11	15	1321-RWR25-DP	✓	✓
	15	20	1321-RWR35-DP	—	✓
	18.5	25	1321-RWR45-DP	—	✓
	22	30	1321-RWR55-DP	—	✓
	30	40	1321-RWR80-DP	—	✓
	37	50	1321-RWR80-DP	—	✓
	45	60	1321-RWR100-DP	—	✓
	55	75	1321-RWR130-DP	—	✓
	75	100	1321-RWR160-DP	—	✓
	90	125	1321-RWR200-DP	—	✓
	110	150	1321-RWR250-DP	—	✓
149	200	1321-RWR320-DP	—	✓	
187	250	1321-RWR320-DP	—	✓	

Communication Option Kits

Description	Cat. No.	Used with PowerFlex Drive	
		4M	400
BACnet® MS/TP RS485 Communication Adapter	22-COMM-B	—	✓
ControlNet™ Communication Adapter	22-COMM-C	✓ ⁽¹⁾	✓
DeviceNet™ Communication Adapter	22-COMM-D	✓ ⁽¹⁾	✓
EtherNet/IP™ Communication Adapter	22-COMM-E	✓ ⁽¹⁾	✓
LonWorks® Communication Adapter	22-COMM-L	—	✓
PROFIBUS™ DP Communication Adapter	22-COMM-P	✓ ⁽¹⁾⁽²⁾	✓
Serial Converter Module (RS485 to RS232). Provides serial communication via DF1 protocol for use with DriveExplorer™ and DriveExecutive™ software. Includes DSI to RS232 serial converter, 1203-SFC serial cable, 22-RJ45CBL-C20 cable, and DriveExplorer Lite CD.	22-SCM-232	✓	✓
Serial Cable. 2.0 meter with a locking low profile connector. Connects the serial converter to a 9-pin sub-miniature D female computer connector.	1203-SFC	✓	✓
Serial Null Modem Adapter. Use when connecting the serial converter to DriveExplorer on a handheld PC.	1203-SNM	✓	✓
Universal Serial Bus™ (USB) Converter includes 2m USB, 20-HIM-H10 and 22-HIM-H10 Cables.	1203-USB	✓	✓
DSI Cable. 2.0 meter RJ45 to RJ45 cable, male to male connectors.	22-RJ45CBL-C20	✓	✓
Splitter Cable. RJ45 one to two port splitter cable.	AK-U0-RJ45-SC1	✓	✓
Terminal Block. RJ45 two position terminal block (6 pieces) with two 120 Ohm terminating resistors (loose).	AK-U0-RJ45-TB2P	✓	✓
Terminating Resistors. 120 Ohm resistor embedded in an RJ45 connector (2 pieces).	AK-U0-RJ45-TR1	✓	✓
DSI External Communications Kit. External mounting kit for 22-COMM Communication Adapters.	22-XCOMM-DC-BASE	✓	✓
External Communications Kit Power Supply Optional 100...240V AC Power Supply for External DSI Communications Kit.	20-XCOMM-AC-PS1	✓	✓
Compact I/O Module (3 Channel)	1769-SM2	✓	✓
Serial Flash Firmware Kit Updates drive firmware via computer.	AK-U9-FLSH1	—	✓
Communication Adapter Cover Frame C Drive (PowerFlex 400) Note: Cover adds 25 mm (0.98 in.) to the overall depth of the drive.	22C-CCC		✓ ⁽³⁾

- (1) PowerFlex 4 and PowerFlex 4M drives require External DSI Communication Kits. Communication Adapters cannot be drive mounted.
(2) When a 22-COMM-P adapter is configured for multi-drive mode, a PowerFlex 400 drive must be used as a master drive on the network.
(3) If IP30, NEMA/UL Type 1 is required, 22-JBCC must also be ordered; see IP30, NEMA/UL Type 1 Conversion Kit table.

IP30, NEMA/UL Type 1 Conversion Kit

Description	Frame	Cat. No.	Used with PowerFlex Drive	
			4M	400
Converts IP20 drive to IP30, NEMA/UL Type 1 enclosure. Includes conduit box, mounting screws and plastic top panel.	C	22-JBAC	—	✓
Converts IP20 drive to IP30, NEMA/UL Type 1 enclosure. Includes communication option conduit box, mounting screws and plastic top panel.		22-JBCC		✓

Dynamic Brake Resistors

Drive Rating			Minimum Resistance Ohms ±10%	Resistance ⁽¹⁾ Ohms ±5%	Cat. No. ⁽²⁾	Used with PowerFlex Drive	
Voltage	kW	Hp				4M	400
200...240V, 50/60 Hz, Three-phase	5.5	7.5	13	30	AK-R2-030P1K2	✓	—
	7.5	10	10	30	AK-R2-030P1K2	✓	
380...480V, 50/60 Hz, Three-phase	5.5	7.5	55	120	AK-R2-120P1K2	✓	
	7.5	10	39	120	AK-R2-120P1K2	✓	
	11	15	24	120	AK-R2-120P1K2 ⁽³⁾	✓	

(1) Verify resistor Ohms against minimum resistance for drive being used.

(2) Resistors listed are rated 5% duty cycle.

(3) Requires two resistors wired in parallel.

Spare Parts

Description		Cat. No.	Used with PowerFlex Drive	
			4M	400
Fan Replacement Kits	Fan Replacement Kit - Frame A	SK-U1-FFAN1-A1	✓	—
	Fan Replacement Kit - Frame B	SK-U1-FFAN1-B1	✓	—
	Fan Replacement Kit - Frame C	SK-U1-FFAN1-C1	✓	—
	Fan Replacement Kit - Frame C, 1 Fan	SK-U1-FAN1-C1	—	✓ ⁽¹⁾
	Fan Replacement Kit - Frame C, 1 Fan, 15 Hp	SK-U1-FAN1-C2	—	✓ ⁽²⁾
	Fan Replacement Kit - Frame D, 2 Fans, B049...B090 & D038...D060 Ratings	SK-U1-FAN2-D1	—	✓
	Fan Replacement Kit - Frame E, 2 Fans, B120...B145 & D072...D142 Ratings	SK-U1-FAN2-E2	—	✓
	Fan Replacement Kit - Frame F, 2 Fans, IGBT, D170 & D208 Ratings	SK-U1-FAN2-F1	—	✓
	Fan Replacement Kit - Frame F, 1 Fan, Rectifier, D170 & D208 Ratings	SK-U1-FAN1-F2	—	✓
	Fan Replacement Kit - Frame F, 1 Fan, Choke, D170 & D208 Ratings	SK-U1-FAN1-F3	—	✓
	Fan Replacement Kit - Frame G, 1 Fan (Side), D260 & D310 Ratings	SK-U1-FAN1-G1	—	✓
	Fan Replacement Kit - Frame G, 4 Fans (Bottom), D260 & D310 Ratings	SK-U1-FAN4-G3	—	✓
	Fan Replacement Kit - Frame H, 1 Fan (Upper Side), D370 & D460 Ratings	SK-U1-FAN1-H1	—	✓
	Fan Replacement Kit - Frame H, 1 Fan (Middle Side), D370 & D460 Ratings	SK-U1-FAN1-H2	—	✓
	Fan Replacement Kit - Frame H, 4 Fans (Bottom), D370 & D460 Ratings	SK-U1-FAN4-H3	—	✓
Covers	Frame A Cover	SK-U1-FCVR-A1	✓	—
	Frame B Cover	SK-U1-FCVR-B1	✓	—
	Frame C Cover	SK-U1-FCVR-C1	✓	—
	Frame C Cover with Power Terminal Guard	SK-U1-CCVR1-C1	—	✓
	Frame D Cover	SK-U1-CCVR1-D1	—	✓
	Frame E Cover	SK-U1-CCVR1-E1	—	✓
	Frame F Cover	SK-U1-CCVR1-F1	—	✓
	Frame G Cover	SK-U1-CCVR1-G1	—	✓
	Frame H Cover	SK-U1-CCVR1-H1	—	✓

(1) 3...10 Hp at 200...240V AC and 3...10 Hp at 380...480V AC.

(2) 15...20 Hp at 380...480V AC.

EMC Filters (Required to Meet CE Certification)

Drive Ratings			PowerFlex 4M		PowerFlex 400	
Input Voltage	kW	Hp	S Type Filter Cat. No. ⁽¹⁾	L Type Filter Cat. No. ⁽²⁾	IP00 (NEMA/UL Type Open) Cat. No. ⁽¹⁾	
100...120V, 50/60 Hz, Single-phase	0.2	0.25	—	22F-RF010-AL	—	
	0.4	0.5		22F-RF025-BL		
	0.75	1				
	1.1	1.5				
200...240V, 50/60 Hz, Single-phase	0.2	0.25	⁽³⁾	22F-RF010-AL		
	0.4	0.5		22F-RF025-BL		
	0.75	1				
	1.5	2				
	2.2	3				
200...240V, 50/60 Hz, Three-phase	0.2	0.25	22F-RF9P5-AS	22F-RF9P5-AL		
	0.4	0.5				
	0.75	1				
	1.5	2	22F-RF021-BS	22F-RF021-BL		22-RF034-CS
	2.2	3				
	3.7	5	22F-RF039-CS	22F-RF039-CL		
	5.5	7.5				
	7.5	10	—	—		22-RFD070
	11	15				22-RFD100
	15	20				22-RFD150
	18.5	25				
	22	30				
30	40	22-RFD180				
37	50					

(1) This filter is suitable for use with a cable length of up to 10 meters for Class A and 1 meter for Class B environments.

(2) This filter is suitable for use with a cable length of up to 100 meters for Class A and 5 meters for Class B environments.

(3) Drives are available in these ratings with internal "S Type" filters.

(table continues on next page)

EMC Filters (Required to Meet CE Certification), (continued)

Drive Ratings			PowerFlex 4M		PowerFlex 400
Input Voltage	kW	Hp	S Type Filter Cat. No. ⁽¹⁾	L Type Filter Cat. No. ⁽²⁾	IP00 (NEMA/UL Type Open) Cat. No. ⁽¹⁾
380...480V, 50/60 Hz, Three-phase	0.4	0.5	22F-RF6P0-AS ⁽³⁾	22F-RF6P0-AL	—
	0.75	1			
	1.5	2			
	2.2	3	22F-RF012-BS ⁽³⁾	22F-RF012-BL	22-RF018-CS
	3.7	5			
	5.5	7.5	22F-RF026-CS ⁽³⁾	22F-RF026-CL	22-RF026-CS
	7.5	10			
	11	15	—	—	22-RFD036
	15	20			22-RFD050
	18.5	25			22-RFD070
	22	30			22-RFD100
	30	40			22-RFD150
	37	50			22-RFD180
	45	60			22-RFD208
	55	75			22-RFD323
	75	100			22-RFD480
	90	125			
	110	150			
	132	200			
	160	250			
200	300				
250	350				

- (1) This filter is suitable for use with a cable length of up to 10 meters for Class A and 1 meter for Class B environments.
- (2) This filter is suitable for use with a cable length of up to 100 meters for Class A and 5 meters for Class B environments.
- (3) Drives are available in these ratings with internal S Type filters.

DC Series Bus Inductors

Drive Rating				Inductance mH	Cat. No.	Used with PowerFlex Drive	
Voltage	kW	Hp	Amps			4M	400
200...240V, 50/60 Hz, Three-phase	2.2	3	12	1	1321-DC12-1	—	✓
	3.7	5	17.5	0.65	1321-DC18-1		✓
	5.5	7.5	32	0.85	1321-DC32-1		✓
	7.5	10	40	0.75	1321-DC40-2		✓
400...480V, 50/60 Hz, Three-phase	2.2	3	6	2	1321-DC9-2		✓
	4	5	10.5	2.1	1321-DC12-2		✓
	5.5	7.5	18	3.75	1321-DC18-4		✓
	7.5	10	25	1.28	1321-DC25-4		✓
	11	15	32	2.68	1321-DC32-3		✓
	15	20	30	2.5	1321-DC40-4		✓

Isolation Transformers for PowerFlex 400 - IP32, NEMA/UL Type 3R Standalone, 4...6% Nominal Impedance

Rating		Wiring Diagram ⁽¹⁾	208V Primary	230V Primary	460V Primary		575V Primary	
kW	Hp		208V, 60 Hz, Three-phase Secondary Cat. No.	230V, 60 Hz, Three-phase Secondary Cat. No.	230V, 60 Hz, Three-phase Secondary Cat. No.	460V, 60 Hz, Three-phase Secondary Cat. No.	230V, 60 Hz, Three-phase Secondary Cat. No.	460V, 60 Hz, Three-phase Secondary Cat. No.
2.2	3	1	1321-3TW005-XX	1321-3TW005-AA	1321-3TW005-BA	1321-3TW005-BB	1321-3TW005-CA	1321-3TW005-CB
22	30	2	—	1321-3TW040-AA	1321-3TW040-BA	1321-3TW040-BB	1321-3TW040-CA	1321-3TW040-CB
30	40			1321-3TW051-AA	1321-3TW051-BA	1321-3TW051-BB	1321-3TW051-CA	1321-3TW051-CB
37	50			1321-3TH063-AA	1321-3TH063-BA	1321-3TH063-BB	—	—
45	60			—	—	1321-3TH075-BB		
55	75			—	—	1321-3TH093-BB		
75	100			—	—	1321-3TH118-BB		
90	125			—	—	1321-3TH145-BB		
110	150			—	—	1321-3TH175-BB		
132	200			—	—	1321-3TH220-BB		
160	250			—	—	1321-3TH275-BB		
200	300			—	—	1321-3TH330-BB		
250	350			—	—	1321-3TH440-BB		

(1) For the corresponding wiring diagram, see page [137](#).

Line Reactors - 3% Impedance

Drive Ratings				IP00 ⁽¹⁾ (NEMA/UL Open Type) Cat. No.	IP11 ⁽¹⁾ (NEMA/UL Type 1) Cat. No.	Used with PowerFlex Drive	
Voltage	kW	Hp	Amps			4M	400
200...240V, 60 Hz, Three-phase	0.2	0.25	2	1321-3R2-A	—	✓	—
	0.4	0.5	4	1321-3R4-B		✓	
	0.75	1	8	1321-3R8-B		✓	
	1.5	2	8	1321-3R8-A		✓	
	2.2	3	12	1321-3R12-A	1321-3RA12-A	✓	✓
	3.7	5	17.5	1321-3R18-A	1321-3RA18-A	✓	✓
	5.5	7.5	24	1321-3R25-A	1321-3RA25-A	✓	✓
	7.5	10	33	1321-3R35-A	1321-3RA35-A	✓	✓
	11	15	49	1321-3R45-A	1321-3RA45-A	—	✓
	15	20	65	1321-3R55-A	1321-3RA55-A		✓
	18.5	25	75	1321-3R80-A	1321-3RA80-A		✓
	22	30	90	1321-3R80-A	1321-3RA80-A		✓
	30	40	120	1321-3R100-A	1321-3RA100-A		✓
	37	50	145	1321-3R130-A	1321-3RA130-A		✓
37	50	145	1321-3R130-A	1321-3RA130-A	✓		
380...480V, 60 Hz, Three-phase	0.4	0.5	2	1321-3R2-B	—	✓	—
	0.75	1	4	1321-3R4-C		✓	
	1.5	2	4	1321-3R4-B		✓	
	2.2	3	6	1321-3R8-C	1321-3RA8-C	✓	✓
	4	5	10.5	1321-3R8-B	1321-3RA8-B	✓	✓
	5.5	7.5	12	1321-3R12-B	1321-3RA12-B	✓	✓
	7.5	10	17	1321-3R18-B	1321-3RA18-B	✓	✓
	11	15	22	1321-3R25-B	1321-3RA25-B	✓	✓
	15	20	30	1321-3R35-B	1321-3RA35-B	—	✓
	18.5	25	38	1321-3R35-B	1321-3RA35-B		✓
	22	30	45.5	1321-3R45-B	1321-3RA45-B		✓
	30	40	60	1321-3R55-B	1321-3RA55-B		✓
	37	50	72	1321-3R80-B	1321-3RA80-B		✓
	45	60	88	1321-3R80-B	1321-3RA80-B		✓
	55	75	105	1321-3R100-B	1321-3RA100-B		✓
	75	100	142	1321-3R130-B	1321-3RA130-B		✓
	90	125	170	1321-3R160-B	1321-3RA160-B		✓
110	150	208	1321-3R200-B	1321-3RA200-B	✓		

(1) Catalog numbers listed are for 3% impedance. 5% impedance reactor types are also available. Refer to 1321 Power Conditioning Products Technical Data, publication [1321-TD001](#).

PowerFlex 523 AC Drive

0.2...22 kW/0.25...30 Hp in voltages from 100...600V

PowerFlex 523 AC drives are designed to help reduce installation and configuration time with an innovative modular design while providing just enough control for your application. These drives offer convenient programming features with the fast upload and download of configuration files over a standard USB connection, as well as installation flexibility with Zero Stacking and a high ambient operating temperature. PowerFlex 523 AC drives also provide a variety of motor control options, making these drives ideal for simple applications.

PowerFlex 523 at a Glance

Ratings	100...120V 0.2...1.1 kW / 0.25...1.5 Hp / 1.6...6 A 200...240V 0.2...1.5 kW / 0.25...2.0 Hp / 1.6...6.2 A 380...480V 0.4...2.2 kW / 0.5...3.0 Hp / 1.4...4.3 A 525...600V 0.4...2.2 kW / 0.5...3.0 Hp / 0.9...3.2 A	
Motor Control	<ul style="list-style-type: none"> V/Hz Control 	<ul style="list-style-type: none"> Sensorless Vector Control
Enclosures	<ul style="list-style-type: none"> IP20, NEMA/UL Type Open 	<ul style="list-style-type: none"> IP30, NEMA/UL Type 1 (with optional kit)
Additional Features	<ul style="list-style-type: none"> Modular design eases installation Operating temperatures from -20...+50 °C (-4...+122 °F), or -20...+70 °C (-4...+158 °F) with current derating and optional control module fan kit LCD QuickView™ HIM with multi-language support MainsFree™ Programming via USB Configure with Connected Components Workbench software Configure with Studio 5000 Logix Designer™ software 	<ul style="list-style-type: none"> Automatic Device Configuration⁽¹⁾ Economizer motor control for energy savings Application specific parameter group AppView™ and CustomView™ Option for dual port EtherNet/IP adapter. DeviceNet and PROFIBUS DP adapters also available. Conformal coating to IEC 60721 3C2 standards
Certifications	<ul style="list-style-type: none"> AC156 Seismic Standards cULus CE EAC KCC 	<ul style="list-style-type: none"> RCM REACH RoHS SEMI F47
Options	See pages 49...56	

(1) Requires Dual-port EtherNet/IP Option Module (Cat. No. 25-COMM-E2P).

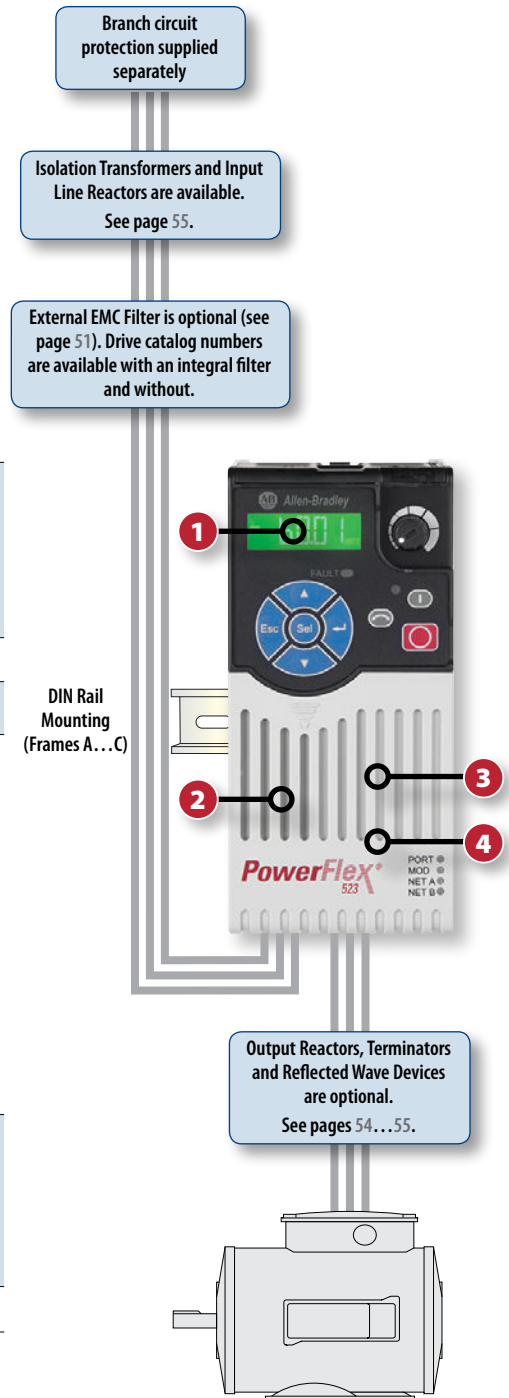

1 LCD QuickView™ Human Interface Module (HIM) with multi-language support in scrolling text. See page 49 for additional options.

2 Communications: Integral RS-485 with Modbus RTU/DSI. Other communication options available and can be added to the drive without size penalty. See page 49 for other options.

3 Embedded I/O: 5 digital inputs, 1 analog input, 1 analog output*, and 1 relay output.

4 Integral brake IGBT. See page 56 for brake resistors.

* Requires Version 3 firmware for the drive, as well as Series B hardware.

Additional Information

PowerFlex 520-Series Technical Data, publication [520-TD001](#)

PowerFlex 520-Series User Manual, publication [520-UM001](#)

Catalog Number Explanation

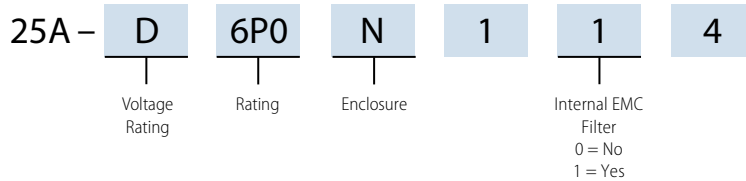

Product Selection

100...120V AC, Single-Phase Input, Three-Phase Output Drives, 50/60 Hz

Drive Ratings					Frame Size	No Filter Cat. No.	With Integral EMC Filter Cat. No.
Normal Duty		Heavy Duty		Output Current			
kW	Hp	kW	Hp	A			
0.2	0.25	0.2	0.25	1.6	A	25A-V1P6N104	—
0.4	0.5	0.4	0.5	2.5		25A-V2P5N104	
0.75	1	0.75	1	4.8	B	25A-V4P8N104	
1.1	1.5	1.1	1.5	6		25A-V6P0N104	

200...240V AC, Single-Phase Input, Three-Phase Output Drives, 50/60 Hz

Drive Ratings					Frame Size	No Filter Cat. No.	With Integral EMC Filter ⁽¹⁾ Cat. No.
Normal Duty		Heavy Duty		Output Current			
kW	Hp	kW	Hp	A			
0.2	0.25	0.2	0.25	1.6	A	25A-A1P6N104	25A-A1P6N114
0.4	0.5	0.4	0.5	2.5		25A-A2P5N104	25A-A2P5N114
0.75	1	0.75	1	4.8		25A-A4P8N104	25A-A4P8N114
1.5	2	1.5	2	8	B	25A-A8P0N104	25A-A8P0N114
2.2	3	2.2	3	11		25A-A011N104	25A-A011N114

(1) This filter is suitable for use with cable lengths up to 10 meters (32.8 feet) for C2 spec and 20 meters (65.6 feet) for C3 spec.

200...240V AC, Three-Phase, 50/60 Hz

Drive Ratings					Frame Size	No Filter Cat. No.	With Integral EMC Filter Cat. No.
Normal Duty		Heavy Duty		Output Current A			
kW	Hp	kW	Hp				
0.2	0.25	0.2	0.25	1.6	A	25A-B1P6N104	—
0.4	0.5	0.4	0.5	2.5		25A-B2P5N104	
0.75	1	0.75	1	5		25A-B5P0N104	
1.5	2	1.5	2	8		25A-B8P0N104	
2.2	3	2.2	3	11		25A-B011N104	
4	5	4	5	17.5	B	25A-B017N104	
5.5	7.5	5.5	7.5	24	C	25A-B024N104	
7.5	10	7.5	10	32.2	D	25A-B032N104	
11	15	7.5	10	48.3	E	25A-B048N104	
15	20	11	15	62.1		25A-B062N104	

380...480V AC, Three-Phase, 50/60 Hz

Drive Ratings					Frame Size	No Filter Cat. No.	With Integral EMC Filter ⁽¹⁾ Cat. No.
Normal Duty		Heavy Duty		Output Current A			
kW	Hp	kW	Hp				
0.4	0.5	0.4	0.5	1.4	A	25A-D1P4N104	25A-D1P4N114
0.75	1	0.75	1	2.3		25A-D2P3N104	25A-D2P3N114
1.5	2	1.5	2	4		25A-D4P0N104	25A-D4P0N114
2.2	3	2.2	3	6		25A-D6P0N104	25A-D6P0N114
4	5	4	5	10.5	B	25A-D010N104	25A-D010N114
5.5	7.5	5.5	7.5	13	C	25A-D013N104	25A-D013N114
7.5	10	7.5	10	17		25A-D017N104	25A-D017N114
11	15	11	15	24	D	25A-D024N104	25A-D024N114
15	20	11	15	30		25A-D030N104	25A-D030N114
18.5	25	15	20	37	E	25A-D037N114 ⁽²⁾	25A-D037N114
22	30	18.5	25	43		25A-D043N114 ⁽²⁾	25A-D043N114

(1) This filter is suitable for use with cable lengths up to 10 meters (32.8 feet) for C2 spec and 20 meters (65.6 feet) for C3 spec.

(2) With EMC filter.

525...600V AC, Three-Phase, 50/60 Hz

Drive Ratings					Frame Size	No Filter Cat. No.	With Integral EMC Filter Cat. No.
Normal Duty		Heavy Duty		Output Current A			
kW	Hp	kW	Hp				
0.4	0.5	0.4	0.5	0.9	A	25A-E0P9N104	—
0.75	1	0.75	1	1.7		25A-E1P7N104	
1.5	2	1.5	2	3		25A-E3P0N104	
2.2	3	2.2	3	4.2		25A-E4P2N104	
4	5	4	5	6.6	B	25A-E6P6N104	
5.5	7.5	5.5	7.5	9.9	C	25A-E9P9N104	
7.5	10	7.5	10	12		25A-E012N104	
11	15	11	15	19	D	25A-E019N104	
15	20	11	15	22		25A-E022N104	
18.5	25	15	20	27	E	25A-E027N104	
22	30	18.5	25	32		25A-E032N104	

Approximate Dimensions and Weights

Dimensions are in mm (in.) - weights are in kg (lb)

IP20, NEMA/UL Type Open

Frame	H	W	D	Weight
A	152 (5.98)	72 (2.83)	172 (6.77)	1.1 (2.4)
B	180 (7.08)	87 (3.42)	172 (6.77)	1.6 (3.5)
C	220 (8.66)	109 (4.29)	184 (7.24)	2.3 (5.1)
D	260 (10.23)	130 (5.11)	212 (8.34)	3.2 (7.1)
E	300 (11.81)	185 (7.28)	279 (10.98)	12.9 (28.4)

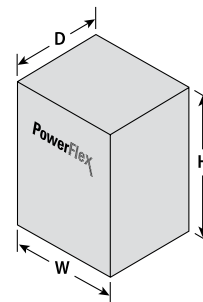

PowerFlex 525 AC Drive

0.4...22 kW/0.5...30 Hp in voltages from 100...600V

PowerFlex 525 AC drives feature an innovative, modular design offering fast and easy installation and configuration. These cost-effective compact drives come with embedded EtherNet/IP™ communications, safety, USB configuration and a high ambient operating temperature capability. PowerFlex 525 AC drives also provide a variety of motor control algorithms including volts per hertz, sensorless vector control, closed loop velocity vector control, and permanent magnet motor control, making these drives ideal for a vast array of applications.

PowerFlex 525 at a Glance

Ratings	100...120V 0.4...1.1 kW / 0.5...1.5 Hp / 2.5...6 A 200...240V 0.4...1.5 kW / 0.5...2.0 Hp / 2.5...62.1 A 380...480V 0.4...2.2 kW / 0.5...3.0 Hp / 1.4...43 A 525...600V 0.4...2.2 kW / 0.5...3.0 Hp / 0.9...32 A	
Motor Control	<ul style="list-style-type: none"> V/Hz Control Sensorless Vector Control 	<ul style="list-style-type: none"> Closed Loop Velocity Vector Control Permanent Magnet Motor Control⁽¹⁾
Enclosures	<ul style="list-style-type: none"> IP20, NEMA/UL Type Open 	<ul style="list-style-type: none"> IP30, NEMA/UL Type 1 (with optional kit)
Safety	<ul style="list-style-type: none"> Safe Torque Off SIL2, PLd, CAT 3 (meets ISO 13849-1) 	
Additional Features	<ul style="list-style-type: none"> Modular design eases installation Operating temperatures from -20...+50 °C (-4...+122 °F), or -20...+70 °C (-4...+158 °F) with current derating and optional control module fan kit Built-in EtherNet/IP port Option for dual port EtherNet/IP adapter LCD QuickView™ HIM with multi-language support MainsFree™ Programming via USB Configure with Connected Components Workbench software 	<ul style="list-style-type: none"> Configure with Studio 5000 Logix Designer™ software Automatic Device Configuration Economizer motor control for energy savings Application specific parameter group AppView™ and CustomView™ Simple positioning control with optional encoder card Conformal coating to IEC 60721 3C2 standards DeviceNet and PROFIBUS DP adapters available
Certifications	<ul style="list-style-type: none"> AC156 Seismic Standards ATEX cULus CE EAC KCC 	<ul style="list-style-type: none"> Lloyd's Register RCM REACH RoHS SEMI F47 TÜV FS
Options	See pages 49...56	

(1) Requires Version 5 firmware for the drive, hardware change is not required.

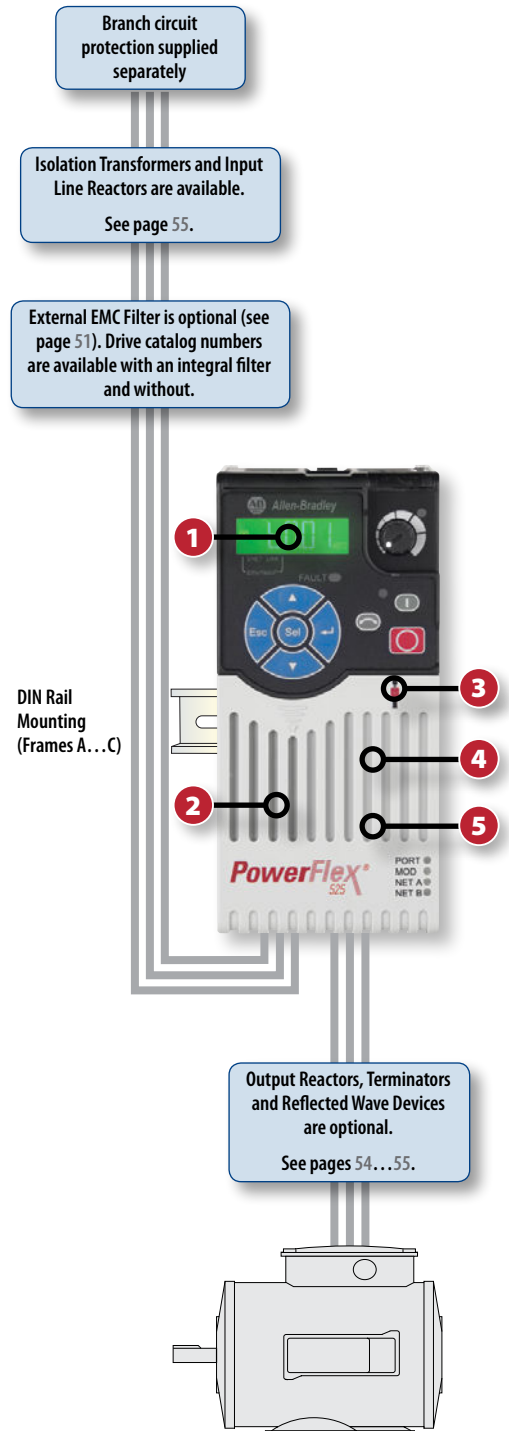

1 LCD QuickView™ Human Interface Module (HIM) with multi-language support in scrolling text. See page 49 for other options.

2 Communications: Built-in EtherNet/IP port with option for dual port EtherNet/IP adapter. See page 49 for additional options.

3 Machine safety with built-in Safe Torque Off SIL2, PLd, CAT 3 (meets ISO 13849-1).

4 Embedded I/O: 7 digital inputs, 2 digital outputs, 2 analog inputs, 1 analog output, and 2 relay outputs.

5 Integral Brake IGBT Transistor. See page 56 for brake resistors.

Additional Information

PowerFlex 520-Series Technical Data, publication [520-TD001](#)

PowerFlex 520-Series User Manual, publication [520-UM001](#)

Catalog Number Explanation

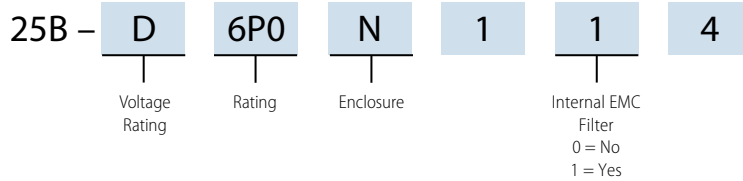

Product Selection

100...120V AC, Single-Phase Input, Three-Phase Output Drives, 50/60 Hz

Drive Ratings						No Filter Cat. No.	With Integral EMC Filter Cat. No.
Normal Duty		Heavy Duty		Output Current A	Frame Size		
kW	Hp	kW	Hp				
0.4	0.5	0.4	0.5	2.5	A	25B-V2P5N104	—
0.75	1	0.75	1	4.8	B	25B-V4P8N104	
1.1	1.5	1.1	1.5	6		25B-V6P0N104	

200...240V AC, Single-Phase Input, Three-Phase Output Drives, 50/60 Hz

Drive Ratings						No Filter Cat. No.	With Integral EMC Filter ⁽¹⁾ Cat. No.
Normal Duty		Heavy Duty		Output Current A	Frame Size		
kW	Hp	kW	Hp				
0.4	0.5	0.4	0.5	2.5	A	25B-A2P5N104	25B-A2P5N114
0.75	1	0.75	1	4.8		25B-A4P8N104	25B-A4P8N114
1.5	2	1.5	2	8	B	25B-A8P0N104	25B-A8P0N114
2.2	3	2.2	3	11		25B-A011N104	25B-A011N114

(1) This filter is suitable for use with cable lengths up to 10 meters (32.8 feet) for C2 spec and 20 meters (65.6 feet) for C3 spec.

200...240V AC, Three-Phase, 50/60 Hz

Drive Ratings						No Filter Cat. No.	With Integral EMC Filter Cat. No.
Normal Duty		Heavy Duty		Output Current A	Frame Size		
kW	Hp	kW	Hp				
0.4	0.5	0.4	0.5	2.5	A	25B-B2P5N104	—
0.75	1	0.75	1	5		25B-B5P0N104	
1.5	2	1.5	2	8		25B-B8P0N104	
2.2	3	2.2	3	11		25B-B011N104	
4	5	4	5	17.5	B	25B-B017N104	
5.5	7.5	5.5	7.5	24	C	25B-B024N104	
7.5	10	7.5	10	32.2	D	25B-B032N104	
11	15	7.5	10	48.3	E	25B-B048N104	
15	20	11	15	62.1		25B-B062N104	

380...480V AC, Three-Phase, 50/60 Hz

Drive Ratings						No Filter Cat. No.	With Integral EMC Filter ⁽¹⁾ Cat. No.
Normal Duty		Heavy Duty		Output Current A	Frame Size		
kW	Hp	kW	Hp				
0.4	0.5	0.4	0.5	1.4	A	25B-D1P4N104	25B-D1P4N114
0.75	1	0.75	1	2.3		25B-D2P3N104	25B-D2P3N114
1.5	2	1.5	2	4		25B-D4P0N104	25B-D4P0N114
2.2	3	2.2	3	6		25B-D6P0N104	25B-D6P0N114
4	5	4	5	10.5	B	25B-D010N104	25B-D010N114
5.5	7.5	5.5	7.5	13	C	25B-D013N104	25B-D013N114
7.5	10	7.5	10	17		25B-D017N104	25B-D017N114
11	15	11	15	24	D	25B-D024N104	25B-D024N114
15	20	11	15	30		25B-D030N104	25B-D030N114
18.5	25	15	20	37	E	25B-D037N114 ⁽²⁾	25B-D037N114
22	30	18.5	25	43		25B-D043N114 ⁽²⁾	25B-D043N114

(1) This filter is suitable for use with cable lengths up to 10 meters (32.8 feet) for C2 spec and 20 meters (65.6 feet) for C3 spec.

(2) With EMC filter.

525...600V AC, Three-Phase, 50/60 Hz

Drive Ratings					Output Current A	Frame Size	No Filter Cat. No.	With Integral EMC Filter Cat. No.
Normal Duty		Heavy Duty						
kW	Hp	kW	Hp					
0.4	0.5	0.4	0.5	0.9	A	25B-E0P9N104	—	
0.75	1	0.75	1	1.7		25B-E1P7N104		
1.5	2	1.5	2	3		25B-E3P0N104		
2.2	3	2.2	3	4.2		25B-E4P2N104		
4	5	4	5	6.6	B	25B-E6P6N104		
5.5	7.5	5.5	7.5	9.9	C	25B-E9P9N104		
7.5	10	7.5	10	12		25B-E012N104		
11	15	11	15	19	D	25B-E019N104		
15	20	11	15	22		25B-E022N104		
18.5	25	15	20	27	E	25B-E027N104		
22	30	18.5	25	32		25B-E032N104		

Approximate Dimensions and Weights

Dimensions are in mm (in.) - weights are in kg (lb)

IP20, NEMA/UL Type Open

Frame	H	W	D	Weight
A	152 (5.98)	72 (2.83)	172 (6.77)	1.1 (2.4)
B	180 (7.08)	87 (3.42)	172 (6.77)	1.6 (3.5)
C	220 (8.66)	109 (4.29)	184 (7.24)	2.3 (5.1)
D	260 (10.23)	130 (5.11)	212 (8.34)	3.2 (7.1)
E	300 (11.81)	185 (7.28)	279 (10.98)	12.9 (28.4)

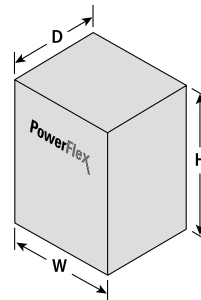

PowerFlex 527 AC Drive

0.4...22 kW/0.5...30 Hp in voltages from 100...600V

PowerFlex 527 AC drives is the first compact PowerFlex drive designed to exclusively work with a Logix controller and programmed with Studio 5000 integrated motion instructions. The PowerFlex 527 drive is an ideal AC drive to complement machines already using Kinetix servo drives. It features a built-in dual port for EtherNet/IP hardwired and networked safety. Using Studio 5000 software, the configuration and programming experience saves start up time, and delivers a coordinated and synchronized machine.

PowerFlex 527 at a Glance

Ratings	100...120V 0.4...1.1 kW / 0.5...1.5 Hp / 2.5...6 A 200...240V 0.4...15 kW / 0.5...20 Hp / 2.5...62.1 A 380...480V 0.4...22 kW / 0.5...30 Hp / 1.4...43 A 525...600V 0.4...22 kW / 0.5...30 Hp / 0.9...32 A	
Motor Control	<ul style="list-style-type: none"> V/Hz Control Sensorless Vector Control Closed Loop Velocity Vector Control 	
Enclosures	<ul style="list-style-type: none"> IP20, NEMA/UL Type Open IP30, NEMA/UL Type 1 (with optional kit) 	
Safety	<ul style="list-style-type: none"> Built-in Hardwire Safe Torque Off, SIL3, PLe, CAT 3 	<ul style="list-style-type: none"> Built-in Networked Safe Torque Off SIL3, PLe, CAT 3
Additional Features	<ul style="list-style-type: none"> Works exclusively with Logix controllers Program with motion instructions in Studio 5000 Logix Designer™ Software Built-in dual port for EtherNet/IP Built-in safety—hardwired or networked Safe Torque Off Removable I/O blocks 	<ul style="list-style-type: none"> Operating temperatures from -20...+50 °C (-4...+122 °F). Up to 70 °C (158 °F) with current derating and optional control module fan kit Optional encoder card Conformal coating to IEC 60721 3C2 standards
Certifications	<ul style="list-style-type: none"> AC156 Seismic Standards ATEX cULus CE EAC KCC Lloyd's Register 	<ul style="list-style-type: none"> ODVA CIP/Safety RCM REACH RoHS SEMI F47 TÜV FS
Options	See pages 49...56	

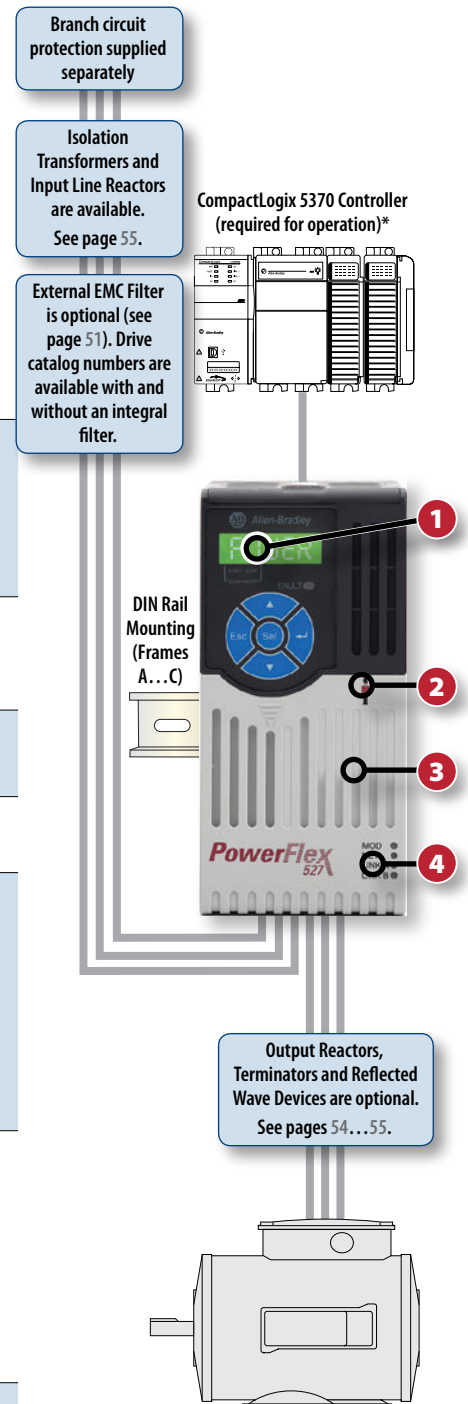

* Requires a Logix controller capable of supporting Motion Instructions at a minimum revision of v24.

1 LCD QuickView™ Human Interface Module (HIM) with multi-language support in scrolling text. See page 49 for other options.

3 Works exclusively with Logix controller. Program with motion instruction in Studio 5000 Logix Designer Software allows a common user experience.

2 Choice of built-in hardwired or networked safety SIL3, PLe, CAT 3. Built-in safety simplifies machine design and minimizes equipment redundancies.

4 Communications: Built-in dual port for EtherNet/IP. See page 49 for additional options.

Additional Information

PowerFlex 520-Series Technical Data, publication [520-TD001](#)

PowerFlex 527 Adjustable Frequency AC Drive User Manual, publication [520-UM002](#)

Catalog Number Explanation

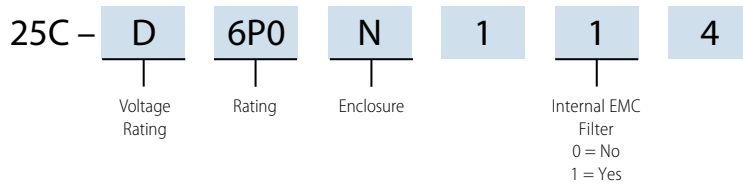

Product Selection

100...120V AC, Single-phase Input, Three-phase Output Drives, 50/60 Hz

Drive Ratings						No Filter Cat. No.	With Integral EMC Filter Cat. No.
Normal Duty		Heavy Duty		Output Current A	Frame Size		
kW	Hp	kW	Hp				
0.4	0.5	0.4	0.5	2.5	A	25C-V2P5N104	—
0.75	1	0.75	1	4.8	B	25C-V4P8N104	
1.1	1.5	1.1	1.5	6		25C-V6P0N104	

200...240V AC, Single-phase Input, Three-phase Output Drives, 50/60 Hz

Drive Ratings						No Filter Cat. No.	With Integral EMC Filter ⁽¹⁾ Cat. No.
Normal Duty		Heavy Duty		Output Current A	Frame Size		
kW	Hp	kW	Hp				
0.4	0.5	0.4	0.5	2.5	A	25C-A2P5N104	25C-A2P5N114
0.75	1	0.75	1	4.8		25C-A4P8N104	25C-A4P8N114
1.5	2	1.5	2	8	B	25C-A8P0N104	25C-A8P0N114
2.2	3	2.2	3	11		25C-A011N104	25C-A011N114

(1) This filter is suitable for use with cable lengths up to 10 meters (32.8 feet) for C2 spec and 20 meters (65.6 feet) for C3 spec.

200...240V AC, Three-phase, 50/60 Hz

Drive Ratings						No Filter Cat. No.	With Integral EMC Filter Cat. No.
Normal Duty		Heavy Duty		Output Current A	Frame Size		
kW	Hp	kW	Hp				
0.4	0.5	0.4	0.5	2.5	A	25C-B2P5N104	—
0.75	1	0.75	1	5		25C-B5P0N104	
1.5	2	1.5	2	8		25C-B8P0N104	
2.2	3	2.2	3	11		25C-B011N104	
4	5	4	5	17.5	B	25C-B017N104	
5.5	7.5	5.5	7.5	24	C	25C-B024N104	
7.5	10	7.5	10	32.2	D	25C-B032N104	
11	15	7.5	10	48.3	E	25C-B048N104	
15	20	11	15	62.1		25C-B062N104	

380...480V AC, Three-phase, 50/60 Hz

Drive Ratings						No Filter Cat. No.	With Integral EMC Filter ⁽¹⁾ Cat. No.
Normal Duty		Heavy Duty		Output Current A	Frame Size		
kW	Hp	kW	Hp				
0.4	0.5	0.4	0.5	1.4	A	25C-D1P4N104	25C-D1P4N114
0.75	1	0.75	1	2.3		25C-D2P3N104	25C-D2P3N114
1.5	2	1.5	2	4		25C-D4P0N104	25C-D4P0N114
2.2	3	2.2	3	6		25C-D6P0N104	25C-D6P0N114
4	5	4	5	10.5	B	25C-D010N104	25C-D010N114
5.5	7.5	5.5	7.5	13	C	25C-D013N104	25C-D013N114
7.5	10	7.5	10	17		25C-D017N104	25C-D017N114
11	15	11	15	24	D	25C-D024N104	25C-D024N114
15	20	11	15	30		25C-D030N104	25C-D030N114
18.5	25	15	20	37	E	25C-D037N114 ⁽²⁾	25C-D037N114
22	30	18.5	25	43		25C-D043N114 ⁽²⁾	25C-D043N114

(1) This filter is suitable for use with cable lengths up to 10 meters (32.8 feet) for C2 spec and 20 meters (65.6 feet) for C3 spec.

(2) With EMC filter.

525...600V AC, Three-phase, 50/60 Hz

Drive Ratings					Output Current A	Frame Size	No Filter Cat. No.	With Integral EMC Filter Cat. No.
Normal Duty		Heavy Duty						
kW	Hp	kW	Hp					
0.4	0.5	0.4	0.5	0.9	A	25C-E0P9N104	—	
0.75	1	0.75	1	1.7		25C-E1P7N104		
1.5	2	1.5	2	3		25C-E3P0N104		
2.2	3	2.2	3	4.2		25C-E4P2N104		
4	5	4	5	6.6	B	25C-E6P6N104		
5.5	7.5	5.5	7.5	9.9	C	25C-E9P9N104		
7.5	10	7.5	10	12		25C-E012N104		
11	15	11	15	19	D	25C-E019N104		
15	20	11	15	22		25C-E022N104		
18.5	25	15	20	27	E	25C-E027N104		
22	30	18.5	25	32		25C-E032N104		

Approximate Dimensions and Weights

Dimensions are in mm (in.) - weights are in kg (lb)

IP20, NEMA/UL Type Open

Frame	H	W	D	Weight
A	152 (5.98)	72 (2.83)	172 (6.77)	1.1 (2.4)
B	180 (7.08)	87 (3.42)	172 (6.77)	1.6 (3.5)
C	220 (8.66)	109 (4.29)	184 (7.24)	2.3 (5.1)
D	260 (10.23)	130 (5.11)	212 (8.34)	3.2 (7.1)
E	300 (11.81)	185 (7.28)	279 (10.98)	12.9 (28.4)

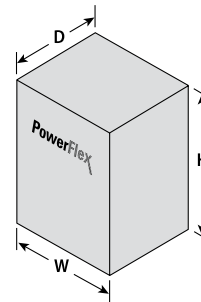

PowerFlex 520-Series Options

Human Interface Modules and Accessories

Description	Cat. No.	Used with PowerFlex Drive		
		PF523	PF525	PF527
Remote (Panel Mount) LCD Display, Digital Speed Control, CopyCat Capable. Includes 2.0 meter cable. IP66, NEMA Type 4X/12 - Indoor Use Only.	22-HIM-C2S ⁽¹⁾	✓	✓	—
Remote Handheld, LCD Display, Full Numeric Keypad, Digital Speed Control, CopyCat Capable. Includes 1.0 meter cable. IP30, NEMA Type 1. Panel mount with optional Bezel Kit.	22-HIM-A3	✓	✓	
Bezel Kit. Panel Mount for LCD Display, Remote Handheld Unit. IP30, NEMA Type 1. Includes a 22-RJ45CBL-C20 cable.	22-HIM-B1	✓	✓	
DSI HIM Cable (DSI HIM to RJ45 cable)				
1.0 Meter (3.3 Feet)	22-HIM-H10	✓	✓	
2.9 Meter (9.5 Feet)	22-HIM-H30	✓	✓	

(1) The 22-HIM-C2S is smaller than the 22-HIM-C2 and cannot be used as a direct replacement.

Communication Option Kits

Description	Cat. No.	Used with PowerFlex Drive		
		PF523	PF525	PF527
DeviceNet™ Communication Adapter	25-COMM-D	✓	✓	—
EtherNet/IP™ Communication Adapter - Dual Port	25-COMM-E2P	✓	✓	
PROFIBUS™ DP Communication Adapter	25-COMM-P	✓	✓	
Serial Converter Module (RS485 to RS232). Provides serial communication via DF1 protocol for use with DriveExplorer™ and DriveExecutive™ software. Includes DSI to RS232 serial converter, 1203-SFC serial cable, 22-RJ45CBL-C20 cable, and DriveExplorer Lite CD.	22-SCM-232	✓	✓	
Serial Cable. 2.0 meter with a locking low profile connector. Connects the serial converter to a 9-pin sub-miniature D female computer connector.	1203-SFC	✓	✓	
Serial Null Modem Adapter. Use when connecting the serial converter to DriveExplorer on a handheld PC.	1203-SNM	✓	✓	
Universal Serial Bus™ (USB) Converter includes 2m USB, 20-HIM-H10 and 22-HIM-H10 Cables.	1203-USB	✓	✓	
DSI Cable. 2.0 meter RJ45 to RJ45 cable, male to male connectors.	22-RJ45CBL-C20	✓	✓	
Splitter Cable. RJ45 one to two port splitter cable.	AK-U0-RJ45-SC1	✓	✓	
Terminal Block. RJ45 two position terminal block (6 pieces) with two 120 Ohm terminating resistors (loose).	AK-U0-RJ45-TB2P	✓	✓	
Terminating Resistors. 120 Ohm resistor embedded in an RJ45 connector (2 pieces).	AK-U0-RJ45-TR1	✓	✓	
DSI External Communications Kit. External mounting kit for 22-COMM Communication Adapters.	22-XCOMM-DC-BASE	✓	✓	
External Communications Kit Power Supply Optional 100...240V AC Power Supply for External DSI Communications Kit.	20-XCOMM-AC-PS1	✓	✓	
Compact I/O Module (3 Channel)	1769-SM2	✓	✓	

Other Options

Description	Frame	Cat. No.	Used with PowerFlex Drive		
			PF523	PF525	PF527 ⁽¹⁾
EMC Grounding Plate	A	25-EMC1-FA	✓	✓	✓
	B	25-EMC1-FB	✓	✓	✓
	C	25-EMC1-FC	✓	✓	✓
	D	25-EMC1-FD	✓	✓	✓
	E	25-EMC1-FE	✓	✓	✓
External EMC Filter Kit (EMC cores)	A	25-CORE-RF-A	✓	✓	✓
	B	25-CORE-RF-B	✓	✓	✓
	C	25-CORE-RF-C	✓	✓	✓
	D	25-CORE-RF-D	✓	✓	✓
	E	25-CORE-RF-E	✓	✓	✓
Mounting Adapter Plate for Bulletin 160 AC Drive to PowerFlex 520-series	A	25-MAP-FA	✓	✓	✓
	B	25-MAP-FB	✓	✓	✓
PowerFlex 525 Incremental Encoder	All	25-ENC-1	—	✓	
PowerFlex 527 Incremental Encoder	All	25-ENC-2			✓
Control Module Fan Kit for 70 °C (158 °F) operation and/or horizontal drive mounting ⁽²⁾	A...D	25-FAN1-70C	✓	✓	✓
	E	25-FAN2-70C	✓	✓	✓
PowerFlex 527 Control Module Internal Fan Kit	All	25C-FAN2-INT	—	—	✓
PowerFlex 527 Control Terminal Block	All	25C-RCTB			✓

(1) PowerFlex 527 AC drives require Logix controller for operation.

(2) Refer to the PowerFlex 527 Adjustable Frequency AC Drive User Manual, publication [520-UM002](#), for detailed guidelines on when to use the control module fan kit.

IP30, NEMA/UL Type 1 Conversion Kit

Description	Frame	Cat. No.	Used with PowerFlex Drive		
			PF523	PF525	PF527
Converts IP20 drive to IP30, NEMA/UL Type 1 enclosure	A	25-JBAA	✓	✓	✓
	B	25-JBAB	✓	✓	✓
	C	25-JBAC	✓	✓	✓
	D	25-JBAD	✓	✓	✓
	E	25-JBAE	✓	✓	✓

EMC Filters (Required to Meet CE Certification)

Drive Ratings Input Voltage	Normal Duty		Heavy Duty		Frame	Cat. No.	Used with PowerFlex Drive		
							PF523	PF525	PF527
100 ... 120V, Single-phase, 50/60 Hz	0.2	0.25	0.2	0.25	A	25-RF011-AL	✓	—	—
	0.4	0.5	0.4	0.5			✓	✓	✓
	0.75	1	0.75	1	B	25-RF023-BL	✓	✓	✓
	1	1.5	1	1.5			✓	✓	✓
200 ... 240V, Single-phase, 50/60 Hz	0.2	0.25	0.2	0.25	A	25-RF011-AL	✓	—	—
	0.4	0.5	0.4	0.5			✓	✓	✓
	0.75	1	0.75	1			✓	✓	✓
	1.5	2	1.5	2	B	25-RF023-BL	✓	✓	✓
	2.2	3	2.2	3			✓	✓	✓
200 ... 240V, Three-phase, 50/60 Hz	0.2	0.25	0.2	0.25	A	25-RF014-AL	✓	—	—
	0.4	0.5	0.4	0.5			✓	✓	✓
	0.75	1	0.75	1			✓	✓	✓
	1.5	2	1.5	2			✓	✓	✓
	2.2	3	2.2	3			✓	✓	✓
	3.7	5	3.7	5	B	25-RF021-BL	✓	✓	✓
	5.5	7.5	5.5	7.5	C	25-RF027-CL	✓	✓	✓
	7.5	10	7.5	10	D	25-RF035-DL	✓	✓	✓
	11	15	7.5	10	E	25-RF056-EL	✓	✓	✓
15	20	11	15	✓			✓	✓	
380 ... 480V, Three-phase 50/60 Hz	0.4	0.5	0.4	0.5	A	25-RF7P5-AL	✓	✓	✓
	0.75	1	0.75	1			✓	✓	✓
	1.5	2	1.5	2			✓	✓	✓
	2.2	3	2.2	3			✓	✓	✓
	3.7	5	3.7	5	B	25-RF014-BL	✓	✓	✓
	5.5	7.5	5.5	7.5	C	25-RF018-CL	✓	✓	✓
	7.5	10	7.5	10			✓	✓	✓
	11	15	11	15	D	25-RF033-DL	✓	✓	✓
	15	18.5	11	15			✓	✓	✓
18.5	22	15	20	E	25-RF039-EL	✓	✓	✓	
22	30	18.5	25			✓	✓	✓	
525 ... 600V, Three-phase, 50/60 Hz	0.4	0.5	0.4	0.5	A	25-RF8P0-BL	✓	✓	✓
	0.75	1	0.75	1			✓	✓	✓
	1.5	2	1.5	2			✓	✓	✓
	2.2	3	2.2	3			✓	✓	✓
	3.7	5	3.7	5	B		✓	✓	✓
	5.5	7.5	5.5	7.5	C	25-RF014-CL	✓	✓	✓
	7.5	10	7.5	10			✓	✓	✓
	11	15	11	15	D	25-RF027-DL	✓	✓	✓
	15	18.5	11	15			✓	✓	✓
	18.5	22	15	20	E	25-RF029-EL	✓	✓	✓
22	30	18.5	25	✓			✓	✓	

Power Modules⁽¹⁾

Drive Ratings Input Voltage	Normal Duty		Heavy Duty		Frame	No Filter	Used with PowerFlex Drive			With Integral EMC Filter	Used with PowerFlex Drive		
	kW	Hp	kW	Hp		Cat No.	PF523	PF525	PF527	Cat No.	PF523	PF525	PF527
100...120V AC, Single-phase, 50/60 Hz	0.2	0.25	0.2	0.25	A	25-PM1-V1P6	✓	—	—	—	✓	—	—
	0.4	0.5	0.4	0.5		25-PM1-V2P5	✓	✓	✓		✓	✓	✓
	0.75	1	0.75	1	B	25-PM1-V4P8	✓	✓	✓		✓	✓	✓
	1	1.5	1	1.5		25-PM1-V6P0	✓	✓	✓		✓	✓	✓
200...240V AC, Single-phase, 50/60 Hz	0.2	0.25	0.2	0.25	A	25-PM1-A1P6	✓	—	—	25-PM2-A1P6	✓	—	—
	0.4	0.5	0.4	0.5		25-PM1-A2P5	✓	✓	✓	25-PM2-A2P5	✓	✓	✓
	0.75	1	0.75	1		25-PM1-A4P8	✓	✓	✓	25-PM2-A4P8	✓	✓	✓
	1.5	2	1.5	2	B	25-PM1-A8P0	✓	✓	✓	25-PM2-A8P0	✓	✓	✓
	2.2	3	2.2	3		25-PM1-A011	✓	✓	✓	25-PM2-A011	✓	✓	✓
200...240V AC, Three-phase, 50/60 Hz	0.2	0.25	0.2	0.25	A	25-PM1-B1P6	✓	—	—	—	✓	—	—
	0.4	0.5	0.4	0.5		25-PM1-B2P5	✓	✓	✓		✓	✓	
	0.75	1	0.75	1		25-PM1-B5P0	✓	✓	✓		✓	✓	
	1.5	2	1.5	2		25-PM1-B8P0	✓	✓	✓		✓	✓	
	2.2	3	2.2	3		25-PM1-B011	✓	✓	✓		✓	✓	
	3.7	5	3.7	5	B	25-PM1-B017	✓	✓	✓		✓	✓	✓
	5.5	7.5	5.5	7.5	C	25-PM1-B024	✓	✓	✓		✓	✓	✓
	7.5	10	7.5	10	D	25-PM1-B032	✓	✓	✓		✓	✓	✓
	11	15	7.5	10	E	25-PM1-B048	✓	✓	✓		✓	✓	✓
	15	20	11	15		25-PM1-B062	✓	✓	✓		✓	✓	✓
380...480V AC, Three-phase, 50/60 Hz	0.4	0.5	0.4	0.5	A	25-PM1-D1P4	✓	✓	✓	25-PM2-D1P4	✓	✓	✓
	0.75	1	0.75	1		25-PM1-D2P3	✓	✓	✓	25-PM2-D2P3	✓	✓	✓
	1.5	2	1.5	2		25-PM1-D4P0	✓	✓	✓	25-PM2-D4P0	✓	✓	✓
	2.2	3	2.2	3		25-PM1-D6P0	✓	✓	✓	25-PM2-D6P0	✓	✓	✓
	3.7	5	3.7	5	B	25-PM1-D010	✓	✓	✓	25-PM2-D010	✓	✓	✓
	5.5	7.5	5.5	7.5	C	25-PM1-D013	✓	✓	✓	25-PM2-D013	✓	✓	✓
	7.5	10	7.5	10		25-PM1-D017	✓	✓	✓	25-PM2-D017	✓	✓	✓
	11	15	11	15	D	25-PM1-D024	✓	✓	✓	25-PM2-D024	✓	✓	✓
	15	18.5	11	15		25-PM1-D030	✓	✓	✓	25-PM2-D030	✓	✓	✓
	18.5	22	15	20	E	—	✓	✓	✓	25-PM2-D037	✓	✓	✓
	22	30	18.5	25		—	✓	✓	✓	25-PM2-D043	✓	✓	✓

(1) Includes power module front cover (Frames B...E only).

(table continues on next page)

Power Modules⁽¹⁾ (continued)

Drive Ratings Input Voltage	Normal Duty		Heavy Duty		Frame	No Filter	Used with PowerFlex Drive			With Integral EMC Filter	Used with PowerFlex Drive		
	kW	Hp	kW	Hp		Cat No.	PF523	PF525	PF527	Cat No.	PF523	PF525	PF527
525...600V AC, Three-phase, 50/60 Hz	0.4	0.5	0.4	0.5	A	25-PM1-E0P9	✓	✓	✓	—	✓	✓	✓
	0.75	1	0.75	1		25-PM1-E1P7	✓	✓	✓		✓	✓	✓
	1.5	2	1.5	2		25-PM1-E3P0	✓	✓	✓		✓	✓	✓
	2.2	3	2.2	3		25-PM1-E4P2	✓	✓	✓		✓	✓	✓
	3.7	5	3.7	5	B	25-PM1-E6P6	✓	✓	✓		✓	✓	✓
	5.5	7.5	5.5	7.5	C	25-PM1-E9P9	✓	✓	✓		✓	✓	✓
	7.5	10	7.5	10		25-PM1-E012	✓	✓	✓		✓	✓	✓
	11	15	11	15	D	25-PM1-E019	✓	✓	✓		✓	✓	✓
	15	18.5	11	15		25-PM1-E022	✓	✓	✓		✓	✓	✓
	18.5	22	15	20	E	25-PM1-E027	✓	✓	✓		✓	✓	✓
	22	30	18.5	25		25-PM1-E032	✓	✓	✓		✓	✓	✓

(1) Includes power module front cover (Frames B...E only).

Control Module

Description	Frame	Cat. No.	Used with PowerFlex Drive		
			PF523	PF525	PF527
PowerFlex 523 Control Module (includes control module front cover)	All	25A-CTM1	✓	—	—
PowerFlex 525 Control Module (includes control module front cover)	All	25B-CTM1	—	✓	—
PowerFlex 527 Control Module (includes control module front cover)	All	25C-CTM1	—	—	✓

Accessories

Description	Frame	Cat. No.	Used with PowerFlex Drive		
			PF523	PF525	PF527
Power Module Front Cover	B	25-PMFC-FB	✓	✓	✓
	C	25-PMFC-FC	✓	✓	✓
	D	25-PMFC-FD	✓	✓	✓
	E	25-PMFC-FE	✓	✓	✓
PowerFlex 523 Control Module Front Cover	All	25A-CTMFC1	✓	—	—
PowerFlex 525 Control Module Front Cover	All	25B-CTMFC1	—	✓	—
PowerFlex 527 Control Module Front Cover	All	25C-CTMFC1	—	—	✓
Heatsink Fan Kit	A	25-FAN1-FA	✓	✓	✓
	B	25-FAN1-FB	✓	✓	✓
	C	25-FAN1-FC	✓	✓	✓
	D	25-FAN1-FD	✓	✓	✓
	E	25-FAN1-FE	✓	✓	✓
Power Terminal Guard	A	25-PTG1-FA	✓	✓	✓
	B	25-PTG1-FB	✓	✓	✓
	C	25-PTG1-FC	✓	✓	✓
	D	25-PTG1-FD	✓	✓	✓
	E	25-PTG1-FE	✓	✓	✓

(table continues on next page)

Accessories (continued)

Description	Frame	Cat. No.	Used with PowerFlex Drive		
			PF523	PF525	PF527
EMC Ferrite Core for Drive with Internal Filter	A	25-CORE-A	✓	✓	✓
	B	25-CORE-B	✓	✓	✓
	C	25-CORE-C	✓	✓	✓
	D	25-CORE-D	✓	✓	✓
	E	25-CORE-E	✓	✓	✓
EMC Ferrite Core for Drive with External Filter	A	25-CORE-RF-A	✓	✓	✓
	B	25-CORE-RF-B	✓	✓	✓
	C	25-CORE-RF-C	✓	✓	✓
	D	25-CORE-RF-D	✓	✓	✓
	E	25-CORE-RF-E	✓	✓	✓

Terminators

Description ⁽¹⁾	Cat. No.	Used with PowerFlex Drive		
		PF523	PF525	PF527
For use with 3.7 kW (5 Hp) and below drives	1204-TFA1	✓	✓	✓
For use with 1.5 kW (2 Hp) and up drives	1204-TFB2	✓	✓	✓

(1) For selection information, refer to Appendix A of the Wiring and Grounding Guidelines for Pulse Width Modulated (PWM) AC Drives, publication [DRIVES-IN001](#).

Reflected Wave Reduction Module with Common Mode Choke

Description ⁽¹⁾	Cat. No.	Used with PowerFlex Drive		
		PF523	PF525	PF527
17A with Common Mode Choke	1204-RWC-17-A	✓	✓	✓

(1) For selection information, refer to Appendix A of the Wiring and Grounding Guidelines for Pulse Width Modulated (PWM) AC Drives, publication [DRIVES-IN001](#).

Reflected Wave Reduction Modules

Drive Ratings Input Voltage	Normal Duty		Heavy Duty		No Filter	Used with PowerFlex Drive		
	kW	Hp	kW	Hp	Cat. No.	PF523	PF525	PF527
380...480V, Three-phase, 50/60 Hz	2.2	3	2.2	3	1321-RWR8-DP	✓	✓	✓
	3.7	5	3.7	5	1321-RWR12-DP	✓	✓	✓
	5.5	7.5	5.5	7.5	1321-RWR18-DP	✓	✓	✓
	7.5	10	7.5	10	1321-RWR25-DP	✓	✓	✓
	11	15	11	15	1321-RWR25-DP	✓	✓	✓
	15	18.5	11	15	1321-RWR35-DP	✓	✓	✓
	18.5	22	15	20	1321-RWR45-DP	✓	✓	✓
525...600V, Three-phase, 50/60 Hz	2.2	3	2.2	3	1321-RWR55-DP	✓	✓	✓
	3.7	5	3.7	5	1321-RWR8-EP	✓	✓	✓
	5.5	7.5	5.5	7.5	1321-RWR12-EP	✓	✓	✓
	7.5	10	7.5	10	1321-RWR18-EP	✓	✓	✓
	11	15	11	15	1321-RWR25-EP	✓	✓	✓

Line Reactors - 3% Impedance

Voltage	Drive Ratings			IP00 ⁽¹⁾ (NEMA/UL Open Type) Cat. No.	IP11 ⁽¹⁾ (NEMA/UL Type 1) Cat. No.
	kW	Hp	Amps		
200...240V, 60 Hz, Three-phase	0.4	0.5	4	1321-3R4-B	1321-3RA4-B
	0.75	1	8	1321-3R8-B	1321-3RA8-B
	1.5	2	8	1321-3R8-A	1321-3RA8-A
	2.2	3	12	1321-3R12-A	1321-3RA12-A
	3.7	5	17.5	1321-3R18-A	1321-3RA18-A
	5.5	7.5	24	1321-3R25-A	1321-3RA25-A
	7.5	10	33	1321-3R35-A	1321-3RA35-A
	11	15	49	1321-3R45-A	1321-3RA45-A
	15	20	65	1321-3R55-A	1321-3RA55-A
380...480V, 60 Hz, Three-phase	0.4	0.5	2	1321-3R2-B	1321-3RA2-B
	0.75	1	4	1321-3R4-C	1321-3RA4-C
	1.5	2	4	1321-3R4-B	1321-3RA4-B
	2.2	3	6	1321-3R8-C	1321-3RA8-C
	4	5	10.5	1321-3R8-B	1321-3RA8-B
	5.5	7.5	12	1321-3R12-B	1321-3RA12-B
	7.5	10	17	1321-3R18-B	1321-3RA18-B
	11	15	22	1321-3R25-B	1321-3RA25-B
	15	20	30	1321-3R35-B	1321-3RA35-B
	18.5	25	38		
22	30	45.5	1321-3R45-B	1321-3RA45-B	
500...600V, 60 Hz, Three-phase	0.75	1	2	1321-3R2-B	1321-3RA2-B
	1.5	2	4	1321-3R4-C	1321-3RA4-C
	2.2	3	4	1321-3R4-B	1321-3RA4-B
	4	5	8	1321-3R8-C	1321-3RA8-C
	5.5	7.5	12	1321-3R12-B	1321-3RA12-B
	7.5	10	12		
	11	15	18	1321-3R18-B	1321-3RA18-B
	15	20	25	1321-3R25-B	1321-3RA25-B
	18.5	25	35	1321-3R35-C	1321-3RA35-C
	22	30	35	1321-3R35-B	1321-3RA35-B

(1) Catalog numbers listed are for 3% impedance. 5% impedance reactor types are also available. Refer to 1321 Power Conditioning Products Technical Data, publication [1321-ID001](#).

Dynamic Brake Resistors

Drive Rating			Minimum Resistance	Resistance	Cat. No. ⁽¹⁾⁽²⁾	
Voltage	Hp	kW	Ohms, ±10%	Ohms, ±5%		
100...120V, 50/60 Hz, Single-phase	0.25	0.2	56	91	AK-R2-091P500	
	0.5	0.4				
	1.0	0.75				
	1.5	1.1	41			
200...240V, 50/60 Hz, Single-phase	0.25	0.2	56	91	AK-R2-091P500	
	0.5	0.4				
	1.0	0.75				
	2.0	1.5	41			
	3.0	2.2	32	47		AK-R2-047P500
200...240V, 50/60 Hz, Three-phase	0.25	0.2	56	91	AK-R2-091P500	
	0.5	0.4				
	1.0	0.75				
	2.0	1.5				41
	3.0	2.2	32	47		AK-R2-047P500
	5.0	4.0	18			
	7.5	5.5	16	30		AK-R2-030P1K2
	10.0	7.5	14	15		AK-R2-030P1K2 ⁽³⁾
	15.0	11.0				
	20.0	15.0	10			
380...480V, 50/60 Hz, Three-phase	0.5	0.4	89	360	AK-R2-360P500	
	1.0	0.75				
	2.0	1.5				
	3.0	2.2				
	5.0	4.0	47	120		AK-R2-120P1K2
	7.5	5.5				
	10.0	7.5				
	15.0	11.0	43	60		AK-R2-120P1K2 ⁽³⁾
	20.0	15.0	27	40		AK-R2-120P1K2 ⁽⁴⁾
	25.0	18.5				
	30.0	22.0				
525...600V, 50/60 Hz, Three-phase	0.5	0.4	112	360	AK-R2-360P500	
	1.0	0.75				
	2.0	1.5				
	3.0	2.2				
	5.0	4.0	86	120		AK-R2-120P1K2
	7.5	5.5				
	10.0	7.5				
	15.0	11.0	59	60		AK-R2-120P1K2 ⁽³⁾
	20.0	15.0				
	25.0	18.5				
30.0	22.0	53	40	AK-R2-120P1K2 ⁽⁴⁾		
		34				

- (1) Resistors listed are rated 5% duty cycle.
- (2) Use of Rockwell Automation resistors is recommended. The resistors listed have been carefully selected for optimizing performance in a variety of applications. Alternative resistors may be used, however, care must be taken when making a selection. Refer to the PowerFlex Dynamic Braking Resistor Calculator, publication [PFLEX-AT001](#).
- (3) Requires two resistors wired in parallel.
- (4) Requires three resistors wired in parallel.

PowerFlex 70 AC Drive

0.37...37 kW/0.5...50 Hp in voltages from 200...600V

The PowerFlex 70 offers a compact package of power, control and operator interface, designed to meet the demands for space, simplicity and reliability. This drive provides a broad spectrum of features, allowing you to easily integrate it into your architecture and configure it for most application needs.

PowerFlex 70 at a Glance

Ratings	
200...240V	0.37...18.5 kW / 0.5...25 Hp / 2.2...70 A
380...480V	0.37...37 kW / 0.5...50 Hp / 1.1...72 A
500...600V	0.5...50 Hp / 0.9...52 A
Motor Control	<ul style="list-style-type: none"> V/Hz Control Sensorless Vector Control Vector Control with FORCE Technology (with and without encoder)
Enclosures	<ul style="list-style-type: none"> IP20, NEMA/UL Type 1 Flange Mount IP54, NEMA/UL Type 12 IP66, NEMA/UL Type 4X/12 for indoor use
Certifications	<ul style="list-style-type: none"> ABS cULus CE⁽¹⁾ EAC KCC Lloyd's Register RCM⁽¹⁾ RINA RoHS SEMI F47 TÜV FS
Options	See pages 126...147

(1) Certification testing has not been performed on 600V drives.

Branch circuit protection supplied separately

Isolation Transformers and Input Line Reactors are available. See pages 137...147.

Integral EMC Filter on Frames B...E. External Common Mode Choke is available. See page 135 and 1321 Power Conditioning Products Technical Data, publication 1321-TD001, for additional information.



Output Reactors, Terminators and Reflected Wave Devices are optional. See pages 135...147.

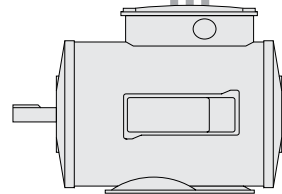

Safety and feedback options are available. See page 129.

1 LCD Programmer shown (not supplied). See page 126 for other options.

2 Multiple communication options for industrial networks are available. See page 127.

3 24V DC I/O Standard. 6 digital inputs, 2 analog inputs, 2 relay outputs, and 1 analog output. 115V interface is available. See page 129.

4 Integral dynamic brake transistor. Internal and external resistors are available. See pages 133...134.

Additional Information

PowerFlex 70 Technical Data, publication [20A-TD001](#)

PowerFlex 70 User Manual, publication [20A-UM001](#)

PowerFlex 70 Installation Instructions, publication [20A-IN009](#)

Catalog Number Explanation

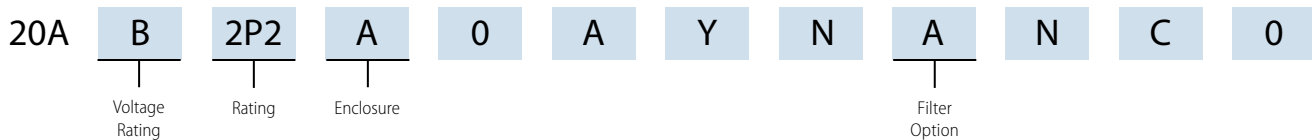

Product Selection

Panel Mount - IP20, NEMA/UL Type 1, No HIM

200...240V AC, Three-phase Drives

240V AC Input						208V AC Input ⁽¹⁾						With Filter	Frame Size
Output Amps			Normal Duty Hp	Heavy Duty Hp	Cat. No.	Output Amps			Normal Duty kW	Heavy Duty kW	Cat. No.		
Cont.	1 min	3 s				Cont.	1 min	3 s					
2.2	2.4	3.3	0.5	0.33	20AB2P2A0AYNNNCO	2.5	2.7	3.7	0.37	0.25	20AB2P2A0AYNNNCO	No	A
					20AB2P2A0AYNANCO						20AB2P2A0AYNANCO	Yes	B
4.2	4.8	6.4	1	0.75	20AB4P2A0AYNNNCO	4.8	5.5	7.4	0.75	0.55	20AB4P2A0AYNNNCO	No	A
					20AB4P2A0AYNANCO						20AB4P2A0AYNANCO	Yes	B
6.8	9	12	2	1.5	20AB6P8A0AYNNNCO	7.8	10.3	13.8	1.5	1.1	20AB6P8A0AYNNNCO	No	B
					20AB6P8A0AYNANCO						20AB6P8A0AYNANCO	Yes	
9.6	10.6	14.4	3	2	20AB9P6A0AYNNNCO	11	12.1	16.5	2.2	1.5	20AB9P6A0AYNNNCO	No	B
					20AB9P6A0AYNANCO						20AB9P6A0AYNANCO	Yes	
15.3	17.4	23.2	5	3	20AB015A0AYNANCO	17.5	19.2	26.2	4	3	20AB015A0AYNANCO	C	D
22	24.2	33	7.5	5	20AB022A0AYNANCO	25.3	27.8	37.9	5.5	4	20AB022A0AYNANCO		
28	33	44	10	7.5	20AB028A0AYNANCO	32.2	37.9	50.6	7.5	5.5	20AB028A0AYNANCO		
42	46.2	63	15	10	20AB042A0AYNANCO	43	55.5	74	11	7.5	20AB042A0AYNANCO		
54	63	84	20	15	20AB054A0AYNANCO	62.1	72.4	96.6	15	11	20AB054A0AYNANCO		
70	81	108	25	20	20AB070A0AYNANCO	78.2	93.1	124	18.5	15	20AB070A0AYNANCO	E	

(1) Drive must be programmed to lower voltage to obtain the currents shown.

Panel Mount - IP20, NEMA/UL Type 1, No HIM (continued)

380...480V AC, Three-phase Drives

480V AC Input						400V AC Input						With Filter	Frame Size
Output Amps			Normal Duty Hp	Heavy Duty Hp	Cat. No.	Output Amps			Normal Duty kW	Heavy Duty kW	Cat. No.		
Cont.	1 min	3 s				Cont.	1 min	3 s					
1.1	1.2	1.6	0.5	0.33	20AD1P1A0AYNNNCO	1.3	1.4	1.9	0.37	0.25	20AC1P3A0AYNNNCO	No	A
					20AD1P1A0AYNANCO						20AC1P3A0AYNANCO	Yes	B
2.1	2.4	3.2	1	0.75	20AD2P1A0AYNNNCO	2.1	2.4	3.2	0.75	0.55	20AC2P1A0AYNNNCO	No	A
					20AD2P1A0AYNANCO						20AC2P1A0AYNANCO	Yes	B
3.4	4.5	6	2	1.5	20AD3P4A0AYNNNCO	3.5	4.5	6	1.5	1.1	20AC3P5A0AYNNNCO	No	A
					20AD3P4A0AYNANCO						20AC3P5A0AYNANCO	Yes	B
5	5.5	7.5	3	2	20AD5P0A0AYNNNCO	5	5.5	7.5	2.2	1.5	20AC5P0A0AYNNNCO	No	B
					20AD5P0A0AYNANCO						20AC5P0A0AYNANCO	Yes	
8	8.8	12	5	3	20AD8P0A0AYNNNCO	8.7	9.9	13.2	4	3	20AC8P7A0AYNNNCO	No	B
					20AD8P0A0AYNANCO						20AC8P7A0AYNANCO	Yes	
11	12.1	16.5	7.5	5	20AD011A0AYNANCO	11.5	13	17.4	5.5	4	20AC011A0AYNANCO		C
14	16.5	22	10	7.5	20AD014A0AYNANCO	15	17.2	23.1	7.5	5.5	20AC015A0AYNANCO		C
22	24.2	33	15	10	20AD022A0AYNANCO	22	24.2	33	11	7.5	20AC022A0AYNANCO		D
27	33	44	20	15	20AD027A0AYNANCO	30	33	45	15	11	20AC030A0AYNANCO		D
34	40.5	54	25	20	20AD034A0AYNANCO	37	45	60	18.5	15	20AC037A0AYNANCO		D
40	51	68	30	25	20AD040A0AYNANCO	43	56	74	22	18.5	20AC043A0AYNANCO		D
52	60	80	40	30	20AD052A0AYNANCO	60	66	90	30	22	20AC060A0AYNANCO		E
65	78	104	50	40	20AD065A0AYNANCO	72	90	120	37	30	20AC072A0AYNANCO		E

500...600V AC, Three-phase Drives

600V AC Input							
Output Amps			Normal Duty Hp	Heavy Duty Hp	Cat. No.	With Filter	Frame Size
Cont.	1 min	3 s					
0.9	1	1.4	0.5	0.33	20AE0P9A0AYNNNCO	No	A
1.7	1.9	2.6	1	0.75	20AE1P7A0AYNNNCO		
2.7	3.6	4.8	2	1	20AE2P7A0AYNNNCO		
3.9	4.3	5.8	3	1.5	20AE3P9A0AYNNNCO		B
6.1	6.7	9.1	5	3	20AE6P1A0AYNNNCO		
9	9.9	13.5	7.5	5	20AE9P0A0AYNNNCO		
11	13.5	18	10	7.5	20AE011A0AYNNNCO		C
17	18.7	25.5	15	10	20AE017A0AYNNNCO		
22	25.5	34	20	15	20AE022A0AYNNNCO		
27	33	44	25	20	20AE027A0AYNNNCO		
32	40.5	54	30	25	20AE032A0AYNNNCO		D
41	48	64	40	30	20AE041A0AYNANCO		
52	61.5	82	50	40	20AE052A0AYNANCO	E	

Wall/Machine Mount - IP66, NEMA/UL Type 4X/12 for Indoor Use with HIM

200...240V AC, Three-phase Drives

240V AC Input						208V AC Input ⁽¹⁾						With Filter	Frame Size
Output Amps			Normal Duty Hp	Heavy Duty Hp	Cat. No.	Output Amps			Normal Duty kW	Heavy Duty kW	Cat. No.		
Cont.	1 min	3 s				Cont.	1 min	3 s					
2.2	2.4	3.3	0.5	0.33	20AB2P2C3AYNNNCO	2.5	2.7	3.7	0.37	0.25	20AB2P2C3AYNNNCO	No	B
					20AB2P2C3AYNANCO						20AB2P2C3AYNANCO	Yes	
4.2	4.8	6.4	1	0.75	20AB4P2C3AYNNNCO	4.8	5.5	7.4	0.75	0.55	20AB4P2C3AYNNNCO	No	
					20AB4P2C3AYNANCO						20AB4P2C3AYNANCO	Yes	
6.8	9	12	2	1.5	20AB6P8C3AYNNNCO	7.8	10.3	13.8	1.5	1.1	20AB6P8C3AYNNNCO	No	
					20AB6P8C3AYNANCO						20AB6P8C3AYNANCO	Yes	
9.6	10.6	14.4	3	2	20AB9P6C3AYNNNCO	11	12.1	16.5	2.2	1.5	20AB9P6C3AYNNNCO	No	
					20AB9P6C3AYNANCO						20AB9P6C3AYNANCO	Yes	
15.3	17.4	23.2	5	3	20AB015C3AYNANCO	17.5	19.2	26.2	4	3	20AB015C3AYNANCO	D	
22	24.2	33	7.5	5	20AB022C3AYNANCO	25.3	27.8	37.9	5.5	4	20AB022C3AYNANCO		
28	33	44	10	7.5	20AB028C3AYNANCO	32.2	37.9	50.6	7.5	5.5	20AB028C3AYNANCO		
42	46.2	63	15	10	20AB042C3AYNANCO	43	55.5	74	11	7.5	20AB042C3AYNANCO		
54	63	84	20	15	20AB054C3AYNANCO	62.1	72.4	96.6	15	11	20AB054C3AYNANCO		
70	81	108	25	20	20AB070C3AYNANCO	78.2	93.1	124	18.5	15	20AB070C3AYNANCO	E	

(1) Drive must be programmed to lower voltage to obtain the currents shown.

380...480V AC, Three-Phase Drives

480V AC Input						400V AC Input						With Filter	Frame Size
Output Amps			Normal Duty Hp	Heavy Duty Hp	Cat. No.	Output Amps			Normal Duty kW	Heavy Duty kW	Cat. No.		
Cont.	1 min	3 s				Cont.	1 Min.	3 Sec.					
1.1	1.2	1.6	0.5	0.33	20AD1P1C3AYNNNCO	1.3	1.4	1.9	0.37	0.25	20AC1P3C3AYNNNCO	No	B
					20AD1P1C3AYNANCO						20AC1P3C3AYNANCO	Yes	
2.1	2.4	3.2	1	0.75	20AD2P1C3AYNNNCO	2.1	2.4	3.2	0.75	0.55	20AC2P1C3AYNNNCO	No	
					20AD2P1C3AYNANCO						20AC2P1C3AYNANCO	Yes	
3.4	4.5	6	2	1.5	20AD3P4C3AYNNNCO	3.5	4.5	6	1.5	1.1	20AC3P5C3AYNNNCO	No	
					20AD3P4C3AYNANCO						20AC3P5C3AYNANCO	Yes	
5	5.5	7.5	3	2	20AD5P0C3AYNNNCO	5	5.5	7.5	2.2	1.5	20AC5P0C3AYNNNCO	No	
					20AD5P0C3AYNANCO						20AC5P0C3AYNANCO	Yes	
8	8.8	12	5	3	20AD8P0C3AYNNNCO	8.7	9.9	13.2	4	3	20AC8P7C3AYNNNCO	No	
					20AD8P0C3AYNANCO						20AC8P7C3AYNANCO	Yes	
11	12.1	16.5	7.5	5	20AD011C3AYNANCO	11.5	13	17.4	5.5	4	20AC011C3AYNANCO	D	
14	16.5	22	10	7.5	20AD014C3AYNANCO	15	17.2	23.1	7.5	5.5	20AC015C3AYNANCO		
22	24.2	33	15	10	20AD022C3AYNANCO	22	24.2	33	11	7.5	20AC022C3AYNANCO		
27	33	44	20	15	20AD027C3AYNANCO	30	33	45	15	11	20AC030C3AYNANCO		
34	40.5	54	25	20	20AD034C3AYNANCO	37	45	60	18.5	15	20AC037C3AYNANCO		
40	51	68	30	25	20AD040C3AYNANCO	43	56	74	22	18.5	20AC043C3AYNANCO		
52	60	80	40	30	20AD052C3AYNANCO	60	66	90	30	22	20AC060C3AYNANCO		
65	78	104	50	40	20AD065C3AYNANCO	72	90	120	37	30	20AC072C3AYNANCO	E	

Wall / Machine Mount - IP66, NEMA/UL Type 4X/12 for Indoor Use with HIM (continued)

500...600V AC, Three-phase Drives

600V AC Input						With Filter	Frame Size
Output Amps			Normal Duty Hp	Heavy Duty Hp	Cat. No.		
Cont.	1 min	3 s					
0.9	1	1.4	0.5	0.33	20AE0P9C3AYNNNCO	No	B
1.7	1.9	2.6	1	0.75	20AE1P7C3AYNNNCO		
2.7	3.6	4.8	2	1	20AE2P7C3AYNNNCO		
3.9	4.3	5.8	3	1.5	20AE3P9C3AYNNNCO		
6.1	6.7	9.1	5	3	20AE6P1C3AYNNNCO		
9	9.9	13.5	7.5	5	20AE9POC3AYNNNCO		D
11	13.5	18	10	7.5	20AE011C3AYNNNCO		
17	18.7	25.5	15	10	20AE017C3AYNNNCO		
22	25.5	34	20	15	20AE022C3AYNNNCO		
27	33	44	25	20	20AE027C3AYNNNCO		
32	40.5	54	30	25	20AE032C3AYNNNCO	E	
41	48	64	40	30	20AE041C3AYNANCO		
52	61.5	82	50	40	20AE052C3AYNANCO		

Wall/Machine Mount - IP54, NEMA/UL Type 12, with HIM

200...240V AC, Three-phase Drives

240V AC Input					208V AC Input ⁽¹⁾					Cat. No.	With Filter	Frame Size
Output Amps			Normal Duty Hp	Heavy Duty Hp	Output Amps			Normal Duty kW	Heavy Duty kW			
Cont.	1 min	3 s			Cont.	1 min	3 s					
54	63	84	20	15	62.1	72.4	96.6	15	11	20AB054G3AYNANCO	Yes	E
70	81	108	25	20	78.2	93.1	124	18.5	15	20AB070G3AYNANCO		

(1) Drive must be programmed to lower voltage to obtain the currents shown.

380...480V AC, Three-phase Drives

480V AC Input						400V AC Input						With Filter	Frame Size
Output Amps			Normal Duty Hp	Heavy Duty Hp	Cat. No.	Output Amps			Normal Duty kW	Heavy Duty kW	Cat. No.		
Cont.	1 min	3 s				Cont.	1 min	3 s					
52	60	80	40	30	20AD052G3AYNANCO	60	66	90	30	22	20AC060G3AYNANCO	Yes	E
65	78	104	50	40	20AD065G3AYNANCO	72	90	120	37	30	20AC072G3AYNANCO		

500...600V AC, Three-phase Drives

600V AC Input						With Filter	Frame Size
Output Amps			Normal Duty Hp	Heavy Duty Hp	Cat. No.		
Cont.	1 min	3 s					
41	48	64	40	30	20AE041G3AYNANCO	Yes	E
52	61.5	82	50	40	20AE052G3AYNANCO		

Flange Mount

Front Chassis = IP20, NEMA/UL Type 1, Heatsink = IP66, NEMA/UL Type 4X/12, No HIM

200...240V AC, Three-phase Drives

240V AC Input						208V AC Input ⁽¹⁾						With Filter	Frame Size
Output Amps			Normal Duty Hp	Heavy Duty Hp	Cat. No.	Output Amps			Normal Duty kW	Heavy Duty kW	Cat. No.		
Cont.	1 min	3 s				Cont.	1 min	3 s					
2.2	2.4	3.3	0.5	0.33	20AB2P2FOAYNNNCO	2.5	2.7	3.7	0.37	0.25	20AB2P2FOAYNNNCO	No	A
					20AB2P2FOAYNANCO						20AB2P2FOAYNANCO	Yes	B
4.2	4.8	6.4	1	0.75	20AB4P2FOAYNNNCO	4.8	5.5	7.4	0.75	0.55	20AB4P2FOAYNNNCO	No	A
					20AB4P2FOAYNANCO						20AB4P2FOAYNANCO	Yes	B
6.8	9	12	2	1.5	20AB6P8FOAYNNNCO	7.8	10.3	13.8	1.5	1.1	20AB6P8FOAYNNNCO	No	B
					20AB6P8FOAYNANCO						20AB6P8FOAYNANCO	Yes	
9.6	10.6	14.4	3	2	20AB9P6FOAYNNNCO	11	12.1	16.5	2.2	1.5	20AB9P6FOAYNNNCO	No	B
					20AB9P6FOAYNANCO						20AB9P6FOAYNANCO	Yes	
15.3	17.4	23.2	5	3	20AB015FOAYNANCO	17.5	19.2	26.2	4	3	20AB015FOAYNANCO		C
22	24.2	33	7.5	5	20AB022FOAYNANCO	25.3	27.8	37.9	5.5	4	20AB022FOAYNANCO		D
28	33	44	10	7.5	20AB028FOAYNANCO	32.2	37.9	50.6	7.5	5.5	20AB028FOAYNANCO		
42	46.2	63	15	10	20AB042FOAYNANCO	43	55.5	74	11	7.5	20AB042FOAYNANCO		
54	63	84	20	15	20AB054FOAYNANCO	62.1	72.4	96.6	15	11	20AB054FOAYNANCO		E
70	81	108	25	20	20AB070FOAYNANCO	78.2	93.1	124	18.5	15	20AB070FOAYNANCO		

(1) Drive must be programmed to lower voltage to obtain the currents shown.

380...480V AC, Three-phase Drives

480V AC Input						400V AC Input						With Filter	Frame Size
Output Amps			Normal Duty Hp	Heavy Duty Hp	Cat. No.	Output Amps			Normal Duty kW	Heavy Duty kW	Cat. No.		
Cont.	1 min	3 s				Cont.	1 min	3 s					
1.1	1.2	1.6	0.5	0.33	20AD1P1FOAYNNNCO	1.3	1.4	1.9	0.37	0.25	20AC1P3FOAYNNNCO	No	A
					20AD1P1FOAYNANCO						20AC1P3FOAYNANCO	Yes	B
2.1	2.4	3.2	1	0.75	20AD2P1FOAYNNNCO	2.1	2.4	3.2	0.75	0.55	20AC2P1FOAYNNNCO	No	A
					20AD2P1FOAYNANCO						20AC2P1FOAYNANCO	Yes	B
3.4	4.5	6	2	1.5	20AD3P4FOAYNNNCO	3.5	4.5	6	1.5	1.1	20AC3P5FOAYNNNCO	No	A
					20AD3P4FOAYNANCO						20AC3P5FOAYNANCO	Yes	B
5	5.5	7.5	3	2	20AD5P0FOAYNNNCO	5	5.5	7.5	2.2	1.5	20AC5P0FOAYNNNCO	No	B
					20AD5P0FOAYNANCO						20AC5P0FOAYNANCO	Yes	
8	8.8	12	5	3	20AD8P0FOAYNNNCO	8.7	9.9	13.2	4	3	20AC8P7FOAYNNNCO	No	B
					20AD8P0FOAYNANCO						20AC8P7FOAYNANCO	Yes	
11	12.1	16.5	7.5	5	20AD011FOAYNANCO	11.5	13	17.4	5.5	4	20AC011FOAYNANCO		C
14	16.5	22	10	7.5	20AD014FOAYNANCO	15	17.2	23.1	7.5	5.5	20AC015FOAYNANCO		
22	24.2	33	15	10	20AD022FOAYNANCO	22	24.2	33	11	7.5	20AC022FOAYNANCO		D
27	33	44	20	15	20AD027FOAYNANCO	30	33	45	15	11	20AC030FOAYNANCO		
34	40.5	54	25	20	20AD034FOAYNANCO	37	45	60	18.5	15	20AC037FOAYNANCO		
40	51	68	30	25	20AD040FOAYNANCO	43	56	74	22	18.5	20AC043FOAYNANCO		
52	60	80	40	30	20AD052FOAYNANCO	60	66	90	30	22	20AC060FOAYNANCO		E
65	78	104	50	40	20AD065FOAYNANCO	72	90	120	37	30	20AC072FOAYNANCO		

Flange Mount

Front Chassis = IP20, NEMA/UL Type 1, Heatsink = IP66, NEMA/UL Type 4X/12, No HIM (continued)

500...600V AC, Three-phase Drives

Output Amps			600V AC Input			With Filter	Frame Size
Cont.	1 min	3 s	Normal Duty Hp	Heavy Duty Hp	Cat. No.		
0.9	1	1.4	0.5	0.33	20AE0P9FOAYNNNCO	No	A
1.7	1.9	2.6	1	0.75	20AE1P7FOAYNNNCO		
2.7	3.6	4.8	2	1	20AE2P7FOAYNNNCO		
3.9	4.3	5.8	3	1.5	20AE3P9FOAYNNNCO		B
6.1	6.7	9.1	5	3	20AE6P1FOAYNNNCO		
9	9.9	13.5	7.5	5	20AE9P0FOAYNNNCO		C
11	13.5	18	10	7.5	20AE011FOAYNNNCO		
17	18.7	25.5	15	10	20AE017FOAYNNNCO		D
22	25.5	34	20	15	20AE022FOAYNNNCO		
27	33	44	25	20	20AE027FOAYNNNCO		
32	40.5	54	30	25	20AE032FOAYNNNCO		
41	48	64	40	30	20AE041FOAYNANCO		E
52	61.5	82	50	40	20AE052FOAYNANCO		

Approximate Dimensions and Weights

Dimensions are in mm (in.) - weights are in kg (lb)

IP20, NEMA/UL Type 1

Frame	H	W	D	Weight ⁽¹⁾
A	225.7 (8.89)	122.4 (4.82)	179.8 (7.08)	2.71 (6)
B	234.6 (9.24)	171.7 (6.76)		3.6 (7.9)
C	300 (11.81)	185 (7.28)		6.89 (15.2)
D	350 (13.78)	219.9 (8.66)		9.25 (20.4)
E	555.8 (21.88)	280.3 (11.04)	207.1 (8.15)	18.6 (41)

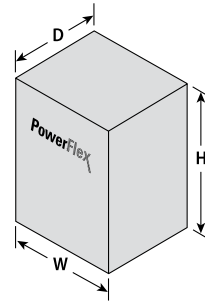

(1) Weights include HIM and I/O.

IP66, NEMA/UL Type 4X/12 for Indoor Use

Frame	H	W	D	Weight ⁽¹⁾
B	239.8 (9.44)	171.7 (6.76)	203.3 (8)	3.61 (8)
D	350 (13.78)	219.9 (8.66)	210.7 (8.29)	9.13 (20.1)
E	555.8 (21.88)	280.3 (11.04)	219.8 (8.65)	18.6 (41)

(1) Weights include HIM and I/O.

Flange Mount

Frame	H	W	D1	D2	Weight ⁽¹⁾
A	225.8 (8.89)	156 (6.14)	123 (4.84)	55.6 (2.19)	2.71 (6)
B	234.6 (9.24)	205.2 (8.08)			3.6 (7.9)
C	300 (11.81)	219 (8.62)			6.89 (15.2)
D	350 (13.78)	248.4 (9.78)	123 (4.84)		9.25 (20.4)
E	555.8 (21.88)	280.3 (11.04)	117.2 (4.61)	89.9 (3.54)	18.6 (41)

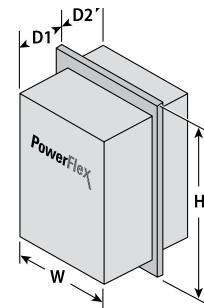

(1) Weights include HIM and I/O.

PowerFlex Architecture-class Drives

The PowerFlex family of drives has been designed to meet a wide variety of applications.

PowerFlex 700 AC Drive



The PowerFlex 700 drive covers a wide range of horsepower ratings and is designed to control three-phase induction motors in applications with requirements ranging from the simplest speed control to the most demanding torque control.

PowerFlex 700 AC Drive at a Glance			
Ratings	200...240V: 0.37...66 kW / 0.5...100 Hp / 2.2...260 A		380...480V: 0.37...500 kW / 0.5...700 Hp / 1.1...875 A
	500...600V: 1...150 Hp / 1.7...144 A		690V: 45...132 kW / 52...142 A
Motor Control	V/Hz Control	Sensorless Vector Control	Vector Control with FORCE Technology (with and without encoder)
Enclosures	IP00, NEMA / UL Type Open	IP20, NEMA / UL Type 1	IP54, NEMA 12 Flange Mount

PowerFlex 700S AC Drive



The PowerFlex 700S offers optimized integration for the most demanding stand-alone and coordinated drive control and drive system applications. The DriveLogix option combines the powerful performance and flexible control of PowerFlex AC drives with a high-performance Logix engine to produce a highly functional, cost effective drive and control solution.

PowerFlex 700S AC Drive at a Glance			
Ratings	200...240V: 0.75...66 kW / 1...100 Hp / 4.2...260 A		380...480V: 0.75...800 kW / 1...1250 Hp / 2.1...1450 A
	500...600V: 1...1600 Hp / 1.7...1500 A		690V: 50...1500 kW / 52...1500 A
Motor Control	V/Hz Control	Vector Control with FORCE Technology (with and without encoder)	Permanent Magnet Motor Control
Enclosures	IP20, NEMA / UL Type1	IP21, NEMA / UL Type 1	

PowerFlex 700L AC Drive



The PowerFlex 700L is available with the PowerFlex 700 or PowerFlex 700S control in a fully regenerative, liquid-cooled power structure that offers great performance and high power. This liquid-cooled drive features regenerative braking, high-response speed and position control, continuous holdback, rapid deceleration, and stopping of high inertia loads.

PowerFlex 700L AC Drive at a Glance		
Ratings	380...480V: 200...860 kW / 268...1150 Hp / 360...1250 A	
	500...600V: 345...650 kW / 465...870 Hp / 4.25...800 A	
Motor Control	690V: 355...657 kW / 475...881 Hp / 380...705 A	
Enclosures	Select PowerFlex 700 or PowerFlex 700S Control	
	IP00, NEMA / UL Type Open (Frame 2)	IP20, NEMA / UL Type 1 (Frames 3A, 3B)

For additional product selection information, please visit <http://ab.rockwellautomation.com/Drives/Low-Voltage-AC-Drives>.

PowerFlex 753 AC Drive

0.37...270 kW/0.5...400 Hp in voltages from 200...690V

Designed for general purpose applications, the PowerFlex 753 AC drive offers multiple options and features along with the added benefit of simple integration. The PowerFlex 753 comes standard with built-in I/O, making it a cost effective solution ideal for OEMs and system integrators looking to reduce engineering costs, deliver machines to market faster and meet end-user demand for more productive and safer machines.

PowerFlex 753 at a Glance

Ratings	200...240V 0.37...132 kW/0.5...200 Hp / 2.2...477 A	
	380...480V 0.75...270 kW / 1.0...400 Hp / 2.1...477 A	
	575...600V 1.0...300 Hp / 1...289 A	
	690V 7.5...250 kW / 12...263 A	
Motor Control	<ul style="list-style-type: none"> V/Hz Control Sensorless Vector Control 	<ul style="list-style-type: none"> Vector Control with FORCE Technology (with and without encoder) Interior Permanent Magnet
Enclosures	<ul style="list-style-type: none"> IP00/IP20, NEMA/UL Type Open Flange Mount 	<ul style="list-style-type: none"> IP54, NEMA/UL Type 12
Safety	<ul style="list-style-type: none"> Safe Torque Off SIL3, PLe, CAT 3 	<ul style="list-style-type: none"> Safe Speed Monitor SIL3, PLe, CAT 4
Additional Features	<ul style="list-style-type: none"> DeviceLogix Predictive Diagnostics Adjustable Voltage Control Three option slots for I/O, feedback, safety, auxiliary control power, communications Indexing 	<ul style="list-style-type: none"> Pump Jack and Pump Off for oil well applications Pump and Traverse for fibers applications Conformal Coating DC Link Choke Automatic Device Configuration⁽¹⁾
Certifications	<ul style="list-style-type: none"> ABS AC156 Seismic Standards ATEX⁽²⁾ cULus CE EAC KCC 	<ul style="list-style-type: none"> Lloyd's Register RCM RINA RoHS SEMI F47 TÜV FS⁽³⁾
Options	See pages 126...147	

(1) Requires Dual-port EtherNet/IP Option Module (Cat. No. 20-750-ENETR), firmware version 7, Studio 5000 Logix Designer, and Drive Add-On Profiles version 4.04 or higher.

(2) Certification requires 11-series I/O and ATEX daughter card options.

(3) Certification applies to 20-750-S and 20-750-S1 Safety Options when installed in drive.

- 1** LCD Human Interface Module (HIM) with multi-language support in scrolling text available as optional accessory. See page 126 for other options.
- 2** Multiple communication options for industrial networks available. See page 126 for additional options.
- 3** Embedded I/O: 3 digital inputs, 1 relay output, 1 transistor output, 1 analog input, 1 analog output, and 1 PTC input. See page 126 for additional options.
- 4** Integral brake resistor on Frames 1...5, optional on Frames 6...7. Resistors are available. See page 135.

Branch circuit protection supplied separately

Isolation Transformers and Input Line Reactors are available. See pages 137...147.

Integral EMC Filter. External Common Mode Choke is available. See page 130 and 1321 Power Conditioning Products Technical Data, publication 1321-TD001, for additional information.



Output Reactors, Terminators and Reflected Wave Devices are optional. See pages 135...147.

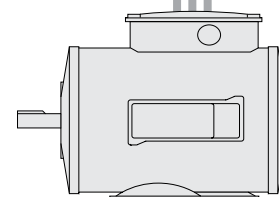

Safety, feedback, and other drive options are available. See pages 129...132.

Additional Information

PowerFlex 750-Series Brochure, publication [750-BR001](#)

PowerFlex 750-Series Technical Data, publication [750-TD001](#)

PowerFlex 750-Series Quick Start Guide, publication [750-QS001](#)

Catalog Number Explanation

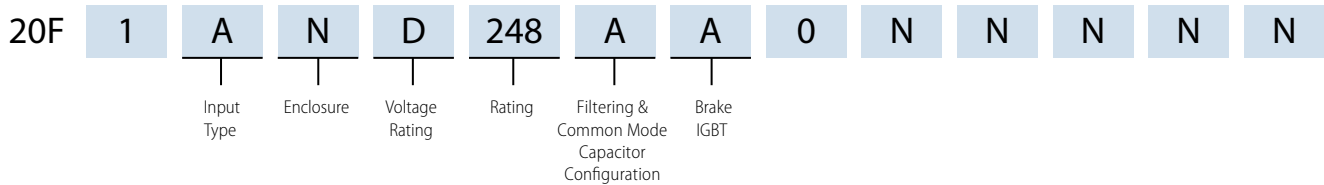

Product Selection

200...240V AC, Three-phase Drives (Available mid-2017)

IP00/IP20, NEMA/UL Type Open⁽¹⁾

Normal Duty					Heavy Duty					Cat. No. ⁽³⁾⁽⁴⁾	Frame Size
Output Amps: 240V (208V) ⁽²⁾					Output Amps: 240V (208V) ⁽²⁾						
Cont.	1 min	3 s	HP	kW	Cont.	1 min	3 s	HP	kW		
2.2 (2.5)	2.4 (2.7)	3.3 (3.7)	0.5	0.37	2.2 (2.5)	3.3 (3.7)	3.9 (4.5)	0.5	0.37	20F11RB2P2JA0NNNNN	1
4.2 (4.8)	4.6 (5.2)	6.3 (7.2)	1	0.75	2.2 (2.5)	4.6 (5.2)	6.3 (7.2)	0.5	0.37	20F11RB4P2JA0NNNNN	
6.8 (7.8)	7.4 (8.5)	10.2 (11.7)	2	1.5	4.2 (4.8)	7.4 (8.5)	10.2 (11.7)	1	0.75	20F11RB6P8JA0NNNNN	
9.6 (11)	10.5 (12.1)	14.4 (16.5)	3	2.2	6.8 (7.8)	10.5 (12.1)	14.4 (16.5)	2	1.5	20F11RB9P6JA0NNNNN	
15.3 (15.3)	16.8 (16.8)	22.9 (22.9)	5	4	9.6 (11)	16.8 (16.8)	22.9 (22.9)	3	2.2	20F11RB015JA0NNNNN	
2.2 (2.5)	3.3 (3.7)	3.9 (4.5)	0.5	0.37	2.2 (2.5)	3.3 (3.7)	3.9 (4.5)	0.5	0.37	20F11NB2P2JA0NNNNN	2
4.2 (4.8)	6.3 (7.2)	7.5 (8.6)	1	0.75	4.2 (4.8)	6.3 (7.2)	7.5 (8.6)	1	0.75	20F11NB4P2JA0NNNNN	
6.8 (7.8)	10.2 (11.7)	12.2 (14)	2	1.5	6.8 (7.8)	10.2 (11.7)	12.2 (14)	2	1.5	20F11NB6P8JA0NNNNN	
9.6 (11)	14.4 (16.5)	17.2 (19.8)	3	2.2	9.6 (11)	14.4 (16.5)	17.2 (19.8)	3	2.2	20F11NB9P6JA0NNNNN	
15.3 (17.5)	16.8 (19.2)	22.9 (26.2)	5	4	9.6 (11)	16.8 (19.2)	22.9 (26.2)	3	2.2	20F11NB015JA0NNNNN	
22 (22)	24.2 (24.2)	33 (33)	7.5	5.5	15.3 (17.5)	24.2 (24.2)	33 (33)	5	4	20F11NB022JA0NNNNN	3
28 (32.2)	30.8 (35.4)	42 (48.3)	10	7.5	22 (22)	33 (35.4)	42 (48.3)	7.5	5.5	20F11NB028JA0NNNNN	
42 (43)	46.2 (47.3)	63 (64.5)	15	11	28 (32.2)	46.2 (48.3)	63 (64.5)	10	7.5	20F11NB042JA0NNNNN	
54 (60)	59.4 (66)	81 (90)	20	15	42 (43)	63 (64.5)	81 (90)	15	11	20F11NB054JA0NNNNN	4
70 (78.2)	77 (86)	105 (117)	25	18.5	54 (60)	81 (90)	105 (117)	20	15	20F11NB070JA0NNNNN	
80 (92)	88 (101)	120 (138)	30	22	70 (78.2)	105 (117)	126 (140)	25	18.5	20F11NB080JA0NNNNN	6
104 (120)	114 (132)	156 (180)	40	30	80 (92)	120 (138)	156 (180)	30	22	20F1ANB104JNONNNNN ⁽⁵⁾	
130 (150)	143 (165)	195 (225)	50	37	104 (120)	156 (180)	195 (225)	40	30	20F1ANB130JNONNNNN ⁽⁵⁾	
154 (177)	169 (194)	231 (265)	60	45	130 (150)	195 (225)	234 (270)	50	37	20F1ANB154JNONNNNN ⁽⁵⁾	
192 (221)	211 (243)	288 (331)	75	55	154 (177)	231 (265)	288 (331)	60	45	20F1ANB192JNONNNNN ⁽⁵⁾	
260 (260)	286 (286)	390 (390)	100	66	192 (221)	288 (331)	390 (390)	75	55	20F1ANB260JNONNNNN ⁽⁵⁾	7
312 (359)	343 (394)	468 (538)	125	90	260 (260)	390 (394)	468 (538)	100	66	20F1ANB312JNONNNNN ⁽⁵⁾	
360 (414)	396 (455)	540 (621)	150	110	312 (359)	468 (538)	561 (646)	125	90	20F1ANB360JNONNNNN ⁽⁵⁾	
477 (477)	524 (524)	715 (715)	200	132	312 (359)	468 (538)	561 (646)	125	90	20F1ANB477JNONNNNN ⁽⁵⁾	

- (1) Frames 1...5 are IP20, NEMA/UL Type Open. Frames 6...7 are IP00, NEMA/UL Type Open. Frames 1...7 can be converted to IP20, NEMA/UL Type 1 with optional kit (20-750-NEMA1-Fx), where x is the frame size.
- (2) Drive must be programmed to lower voltage to obtain the currents shown in parentheses.
- (3) The 5th character determines Input Type; "1" = AC input with precharge and DC terminals, and "A" = AC input with precharge and no DC terminals. For DC input drives, see [DRIVES-SG001](#), the PowerFlex Common Bus Configuration Selection Guide.
- (4) The 11th character determines default Filtering and Common Mode Cap jumper configuration; "J" = Installed, and "A" = Removed.
- (5) The 12th character determines whether an internal dynamic braking IGBT is included; "A" = Internal dynamic braking transistor installed, and "N" = No internal dynamic braking transistor.

200...240V AC, Three-phase Drives (Available mid-2017), (continued)

IP54, NEMA/UL Type 12

Normal Duty					Heavy Duty					Cat. No. ⁽²⁾⁽³⁾	Frame Size
Output Amps: 240V (208V) ⁽¹⁾			HP	kW	Output Amps: 240V (208V) ⁽¹⁾			HP	kW		
Cont.	1 min	3 s			Cont.	1 min	3 s				
2.2 (2.5)	3.3 (3.8)	4 (4.5)	0.5	0.37	2.2 (2.5)	3.3 (3.7)	3.9 (4.5)	0.5	0.37	20F11GB2P2JA0NNNNN	2
4.2 (4.8)	6.3 (7.2)	7.5 (8.6)	1	0.75	4.2 (4.8)	6.3 (7.2)	7.5 (8.6)	1	0.75	20F11GB4P2JA0NNNNN	
6.8 (7.8)	10.2 (11.7)	12.2 (14)	2	1.5	6.8 (7.8)	10.2 (11.7)	12.2 (14)	2	1.5	20F11GB6P8JA0NNNNN	
9.6 (11)	14.4 (16.5)	17.2 (19.8)	3	2.2	9.6 (11)	14.4 (16.5)	17.2 (19.8)	3	2.2	20F11GB9P6JA0NNNNN	
15.3 (17.5)	16.8 (19.2)	22.9 (26.2)	5	4	9.6 (11)	16.8 (19.2)	22.9 (26.2)	3	2.2	20F11GB015JA0NNNNN	
22 (22)	24.2 (24.2)	33 (33)	7.5	5.5	15.3 (17.5)	24.2 (24.2)	33 (33)	5	4	20F11GB022JA0NNNNN	3
28 (32.2)	30.8 (35.4)	42 (48.3)	10	7.5	22 (22)	33 (35.4)	42 (48.3)	7.5	5.5	20F11GB028JA0NNNNN	
42 (43)	46.2 (47.3)	63 (64.5)	15	11	28 (32.2)	46.2 (48.3)	63 (64.5)	10	7.5	20F11GB042JA0NNNNN	
54 (60)	59.4 (66)	81 (90)	20	15	42 (43)	63 (64.5)	81 (90)	15	11	20F11GB054JA0NNNNN	4
70 (78.2)	77 (86)	105 (117)	25	18.5	54 (60)	81 (90)	105 (117)	20	15	20F11GB070JA0NNNNN	5
80 (92)	88 (101)	120 (138)	30	22	70 (78.2)	105 (117)	126 (140)	25	18.5	20F1AGB080JNONNNNN ⁽⁴⁾	6
104 (120)	114 (132)	156 (180)	40	30	80 (92)	120 (138)	156 (180)	30	22	20F1AGB104JNONNNNN ⁽⁴⁾	
130 (150)	143 (165)	195 (225)	50	37	104 (120)	156 (180)	195 (225)	40	30	20F1AGB130JNONNNNN ⁽⁴⁾	
154 (177)	169 (194)	231 (265)	60	45	130 (150)	195 (225)	234 (270)	50	37	20F1AGB154JNONNNNN ⁽⁴⁾	
192 (221)	211 (243)	288 (331)	75	55	154 (177)	231 (265)	288 (331)	60	45	20F1AGB192JNONNNNN ⁽⁴⁾	
260 (260)	286 (286)	390 (390)	100	66	192 (221)	288 (331)	390 (390)	75	55	20F1AGB260JNONNNNN ⁽⁴⁾	7
312 (359)	343 (394)	468 (538)	125	90	260 (260)	390 (394)	468 (538)	100	66	20F1AGB312JNONNNNN ⁽⁴⁾	
360 (414)	396 (455)	540 (621)	150	110	312 (359)	468 (538)	561 (646)	125	90	20F1AGB360JNONNNNN ⁽⁴⁾	

(1) Drive must be programmed to lower voltage to obtain the currents shown in parentheses.

(2) The 5th character determines input type; "1" = AC input with precharge and DC terminals, and "A" = AC input with precharge and no DC terminals. For DC input drives, see [DRIVES-SG001](#), the PowerFlex Common Bus Configuration Selection Guide.

(3) The 11th character determines default Filtering and Common Mode Cap jumper configuration; "J" = Installed, and "A" = Removed.

(4) The 12th character determines whether an internal dynamic braking IGBT is included; "A" = Internal dynamic braking transistor installed, and "N" = No internal dynamic braking transistor.

200...240V AC, Three-phase Drives (Available mid-2017), (continued)

Flange Mount (Front: IP20, NEMA/UL Type Open; Back/Heatsink: IP66, NEMA/UL Type 4X)

Note: Frame 6...7 IP00, NEMA Type Open drives can be converted to a flange mount drive (Back/Heatsink: IP66, NEMA/UL Type 4X) with an optional user installed flange kit (kit 20-750-FLNG4-F6 for Frame 6, and kit 20-750-FLNG4-F7 for Frame 7). See page 67 for 200...240V, Frame 6...7 IP00, NEMA Type Open drives.

Normal Duty					Heavy Duty					Cat. No. ⁽²⁾⁽³⁾	Frame Size
Output Amps: 240V (208V) ⁽¹⁾			HP	kW	Output Amps: 240V (208V) ⁽¹⁾			HP	kW		
Cont.	1 min	3 s			Cont.	1 min	3 s				
2.2 (2.5)	3.3 (3.7)	3.9 (4.5)	0.5	0.37	2.2 (2.5)	3.3 (3.7)	3.9 (4.5)	0.5	0.37	20F11FB2P2JA0NNNNN	2
4.2 (4.8)	6.3 (7.2)	7.5 (8.6)	1	0.75	4.2 (4.8)	6.3 (7.2)	7.5 (8.6)	1	0.75	20F11FB4P2JA0NNNNN	
6.8 (7.8)	10.2 (11.7)	12.2 (14)	2	1.5	6.8 (7.8)	10.2 (11.7)	12.2 (14)	2	1.5	20F11FB6P8JA0NNNNN	
9.6 (11)	14.4 (16.5)	17.2 (19.8)	3	2.2	9.6 (11)	14.4 (16.5)	17.2 (19.8)	3	2.2	20F11FB9P6JA0NNNNN	
15.3 (17.5)	16.8 (19.2)	22.9 (26.2)	5	4	9.6 (11)	16.8 (19.2)	22.9 (26.2)	3	2.2	20F11FB015JA0NNNNN	
22 (22)	24.2 (24.2)	33 (33)	7.5	5.5	15.3 (17.5)	24.2 (24.2)	33 (33)	5	4	20F11FB022JA0NNNNN	3
28 (32.2)	30.8 (35.4)	42 (48.3)	10	7.5	22 (22)	33 (35.4)	42 (48.3)	7.5	5.5	20F11FB028JA0NNNNN	
42 (43)	46.2 (47.3)	63 (64.5)	15	11	28 (32.2)	46.2 (48.3)	63 (64.5)	10	7.5	20F11FB042JA0NNNNN	
54 (60)	59.4 (66)	81 (90)	20	15	42 (43)	63 (64.5)	81 (90)	15	11	20F11FB054JA0NNNNN	4
70 (78.2)	77 (86)	105 (117)	25	18.5	54 (60)	81 (90)	105 (117)	20	15	20F11FB070JA0NNNNN	5
80 (92)	88 (101)	120 (138)	30	22	70 (78.2)	105 (117)	126 (140)	25	18.5	20F11FB080JA0NNNNN	

(1) Drive must be programmed to lower voltage to obtain the currents shown in parentheses.

(2) The 5th character determines Input Type; "1" = AC input with precharge and DC terminals, and "A" = AC input with precharge and no DC terminals. For DC input drives, see [DRIVES-SG001](#), the PowerFlex Common Bus Configuration Selection Guide.

(3) The 11th character determines default Filtering and Common Mode Cap jumper configuration; "J" = Installed, and "A" = Removed.

380...400V AC, Three-phase Drives

IP00/IP20, NEMA/UL Type Open⁽¹⁾

Normal Duty				Heavy Duty				Cat. No. ⁽²⁾⁽³⁾	Frame Size
Output Amps			kW	Output Amps			kW		
Cont.	1 min	3 s		Cont.	1 min	3 s			
2.1	2.3	3.2	0.75	1.3	2.3	3.2	0.37	20F11RC2P1JA0NNNNN	1
3.5	3.9	5.3	1.5	2.1	3.9	5.3	0.75	20F11RC3P5JA0NNNNN	
5	5.5	7.5	2.2	3.5	5.5	7.5	1.5	20F11RC5P0JA0NNNNN	
8.7	9.6	13.1	4	5	9.6	13.1	2.2	20F11RC8P7JA0NNNNN	
11.5	13.1	17.3	5.5	8.7	13.1	17.3	4	20F11RC011JA0NNNNN	
15.4	16.9	23.1	7.5	11.5	17.2	23.1	5.5	20F11RC015JA0NNNNN	
2.1	3.1	3.7	0.75	2.1	3.1	3.7	0.75	20F11NC2P1JA0NNNNN	2
3.5	5.2	6.3	1.5	3.5	5.2	6.3	1.5	20F11NC3P5JA0NNNNN	
5	7.5	9	2.2	5	7.5	9	2.2	20F11NC5P0JA0NNNNN	
8.7	13	15.6	4	8.7	13.0	15.6	4	20F11NC8P7JA0NNNNN	
11.5	17.2	20.7	5.5	11.5	17.2	20.7	5.5	20F11NC011JA0NNNNN	
15.4	16.9	23.1	7.5	11.5	17.2	20.7	5.5	20F11NC015JA0NNNNN	
22	24.2	33	11	15.4	24.2	33	7.5	20F11NC022JA0NNNNN	3
30	33	45	15	22	33	45	11	20F11NC030JA0NNNNN	
37	40.7	55.5	18.5	30	45	55.5	15	20F11NC037JA0NNNNN	
43	47.3	64.5	22	37	55.5	66.6	18.5	20F11NC043JA0NNNNN	
60	66	90	30	43	66	90	22	20F11NC060JA0NNNNN	4
72	79.2	108	37	60	90	108	30	20F11NC072JA0NNNNN	
85	93.5	128	45	72	108	130	37	20F11NC085JA0NNNNN	5
104	114	156	55	85	128	156	45	20F11NC104JA0NNNNN	
140	154	210	75	104	156	210	55	20F11ANC140JNONNNNN ⁽⁴⁾	6
170	187	255	90	140	210	255	75	20F11ANC170JNONNNNN ⁽⁴⁾	
205	226	308	110	170	255	308	90	20F11ANC205JNONNNNN ⁽⁴⁾	
260	286	390	132	205	308	390	110	20F11ANC260JNONNNNN ⁽⁴⁾	
302	332	453	160	260	390	468	132	20F11ANC302JNONNNNN ⁽⁴⁾	7
367	404	551	200	302	453	551	160	20F11ANC367JNONNNNN ⁽⁴⁾	
456	502	684	250	367	551	684	200	20F11ANC456JNONNNNN ⁽⁴⁾	
477	525	716	270	367	551	684	200	20F11ANC477JNONNNNN ⁽⁴⁾	

- (1) Frames 1...5 are IP20, NEMA/UL Type Open. Frames 6...7 are IP00, NEMA/UL Type Open. Frames 1...7 can be converted to IP20, NEMA/UL Type 1 with optional kit (20-750-NEMA1-Fx), where x is the frame size of the drive.
- (2) The 5th character determines Input Type; "1" = AC input with precharge and DC terminals, and "A" = AC input with precharge and no DC terminals. For DC input drives, see [DRIVES-SG001](#), the PowerFlex Common Bus Configuration Selection Guide.
- (3) The 11th character determines default Filtering and Common Mode Cap jumper configuration; "J" = Installed, and "A" = Removed.
- (4) The 12th character determines whether an internal dynamic braking IGBT is included; "A" = Internal dynamic braking transistor installed, and "N" = No internal dynamic braking transistor.

380...400V AC, Three-phase Drives (continued)

IP54, NEMA/UL Type 12

Normal Duty				Heavy Duty				Cat. No. ⁽¹⁾⁽²⁾	Frame Size
Output Amps			kW	Output Amps			kW		
Cont.	1 min	3 s		Cont.	1 min	3 s			
2.1	3.1	3.7	0.75	2.1	3.1	3.7	0.75	20F11GC2P1JA0NNNNN	2
3.5	5.2	6.3	1.5	3.5	5.2	6.3	1.5	20F11GC3P5JA0NNNNN	
5	7.5	9	2.2	5	7.5	9	2.2	20F11GC5P0JA0NNNNN	
8.7	13	15.6	4	8.7	13	15.6	4	20F11GC8P7JA0NNNNN	
11.5	17.2	20.7	5.5	11.5	17.2	20.7	5.5	20F11GC011JA0NNNNN	
15.4	16.9	23.1	7.5	11.5	17.2	20.7	5.5	20F11GC015JA0NNNNN	
22	24.2	33	11	15.4	24.2	33	7.5	20F11GC022JA0NNNNN	
30	33	45	15	22	33	45	11	20F11GC030JA0NNNNN	
37	40.7	55.5	18.5	30	45	55.5	15	20F11GC037JA0NNNNN	
43	47.3	64.5	22	37	55.5	66.6	18.5	20F11GC043JA0NNNNN	
60	66	90	30	43	66	90	22	20F11GC060JA0NNNNN	4
72	79.2	108	37	60	90	108	30	20F11GC072JA0NNNNN	5
85	93.5	128	45	72	108	130	37	20F11GC085JA0NNNNN	
104	114	156	55	85	128	156	45	20F1AGC104JN0NNNNN ⁽³⁾	6
140	154	210	75	104	156	210	55	20F1AGC140JN0NNNNN ⁽³⁾	
170	187	255	90	140	210	255	75	20F1AGC170JN0NNNNN ⁽³⁾	
205	226	308	110	170	255	308	90	20F1AGC205JN0NNNNN ⁽³⁾	
260	286	390	132	205	308	390	110	20F1AGC260JN0NNNNN ⁽³⁾	7
302	332	453	160	260	390	468	132	20F1AGC302JN0NNNNN ⁽³⁾	
367	404	551	200	302	453	551	160	20F1AGC367JN0NNNNN ⁽³⁾	
456	502	684	250	367	551	684	200	20F1AGC456JN0NNNNN ⁽³⁾	

(1) The 5th character determines Input Type; "1" = AC input with precharge and DC terminals, and "A" = AC input with precharge and no DC terminals. For DC input drives, see [DRIVES-SG001](#), the PowerFlex Common Bus Configuration Selection Guide.

(2) The 11th character determines default Filtering and Common Mode Cap jumper configuration; "J" = Installed, and "A" = Removed.

(3) The 12th character determines whether an internal dynamic braking IGBT is included; "A" = Internal dynamic braking transistor installed, and "N" = No internal dynamic braking transistor.

380...400V AC, Three-phase Drives (continued)

Flange Mount (Front: IP20, NEMA/UL Type Open; Back/Heatsink: IP66, NEMA/UL Type 4X)

Note: Frame 6...7 IP00, NEMA Type Open drives can be converted to a flange mount drive (back/heatsink: IP66, NEMA/UL Type 4X) with an optional user installed flange kit (kit 20-750-FLNG4-F6 for Frame 6, and kit 20-750-FLNG4-F7 for Frame 7). See page 70 for 380...400V, Frame 6...7 IP00, NEMA Type Open drives.

Normal Duty				Heavy Duty				Cat. No. ⁽¹⁾⁽²⁾	Frame Size
Output Amps			kW	Output Amps			kW		
Cont.	1 min	3 s		Cont.	1 min	3 s			
2.1	3.1	3.7	0.75	2.1	3.1	3.7	0.75	20F11FC2P1JA0NNNNN	2
3.5	5.2	6.3	1.5	3.5	5.2	6.3	1.5	20F11FC3P5JA0NNNNN	
5	7.5	9	2.2	5	7.5	9	2.2	20F11FC5P0JA0NNNNN	
8.7	13	15.6	4	8.7	13	15.6	4	20F11FC8P7JA0NNNNN	
11.5	17.2	20.7	5.5	11.5	17.2	20.7	5.5	20F11FC011JA0NNNNN	
15.4	16.9	23.1	7.5	11.5	17.2	20.7	5.5	20F11FC015JA0NNNNN	
22	24.2	33	11	15.4	24.2	33	7.5	20F11FC022JA0NNNNN	
30	33	45	15	22	33	45	11	20F11FC030JA0NNNNN	3
37	40.7	55.5	18.5	30	45	55.5	15	20F11FC037JA0NNNNN	
43	47.3	64.5	22	37	55.5	66.6	18.5	20F11FC043JA0NNNNN	
60	66	90	30	43	66	90	22	20F11FC060JA0NNNNN	4
72	79.2	108	37	60	90	108	30	20F11FC072JA0NNNNN	
85	93.5	128	45	72	108	130	37	20F11FC085JA0NNNNN	5
104	114	156	55	85	128	156	45	20F11FC104JA0NNNNN	

(1) The 5th character determines Input Type; "1" = AC input with precharge and DC terminals, and "A" = AC input with precharge and no DC terminals. For DC input drives, see [DRIVES-SG001](#), the PowerFlex Common Bus Configuration Selection Guide.

(2) The 11th character determines default Filtering and Common Mode Cap jumper configuration; "J" = Installed, and "A" = Removed.

460...480V AC, Three-phase Drives

IP00/IP20, NEMA/UL Type Open⁽¹⁾

Normal Duty				Heavy Duty				Cat. No. ⁽²⁾⁽³⁾	Frame Size
Output Amps			Hp	Output Amps			Hp		
Cont.	1 min	3 s		Cont.	1 min	3 s			
2.1	2.3	3.2	1	1.1	2.3	3.2	0.5	20F11RD2P1JA0NNNNN	1
3.4	3.7	5.1	2	2.8	4.2	5.1	1	20F11RD3P4JA0NNNNN	
5	5.5	7.5	3	3.4	5.5	7.5	2	20F11RD5P0JA0NNNNN	
8	8.8	12	5	5	8.8	12	3	20F11RD8P0JA0NNNNN	
11	12.1	16.5	7.5	8	12.1	16.5	5	20F11RD011JA0NNNNN	
14	15.4	21	10	11	16.5	21	7.5	20F11RD014JA0NNNNN	
2.1	3.1	3.7	1	2.1	3.1	3.7	1	20F11ND2P1JA0NNNNN	
3.4	5.1	6.1	2	3.4	5.1	6.1	2	20F11ND3P4JA0NNNNN	
5	7.5	9	3	5	7.5	9	3	20F11ND5P0JA0NNNNN	
8	12	14.4	5	8	12	14.4	5	20F11ND8P0JA0NNNNN	
11	16.5	19.8	7.5	11	16.5	19.8	7.5	20F11ND011JA0NNNNN	
14	15.4	21	10	11	16.5	21	7.5	20F11ND014JA0NNNNN	
22	24.2	33	15	14	24.2	33	10	20F11ND022JA0NNNNN	3
27	29.7	40.5	20	22	33	40.5	15	20F11ND027JA0NNNNN	
34	37.4	51	25	27	40.5	51	20	20F11ND034JA0NNNNN	
40	44	60	30	34	51	61.2	25	20F11ND040JA0NNNNN	
52	57.2	78	40	40	60	78	30	20F11ND052JA0NNNNN	4
65	71.5	97.5	50	52	78	97.5	40	20F11ND065JA0NNNNN	
77	84.7	116	60	65	97.5	116	50	20F11ND077JA0NNNNN	5
96	106	144	75	77	116	144	60	20F11ND096JA0NNNNN	
125	138	188	100	96	144	188	75	20F1AND125JNONNNNN ⁽⁴⁾	6
156	172	234	125	125	188	234	100	20F1AND156JNONNNNN ⁽⁴⁾	
186	205	279	150	156	234	281	125	20F1AND186JNONNNNN ⁽⁴⁾	
248	273	372	200	186	279	372	150	20F1AND248JNONNNNN ⁽⁴⁾	
302	332	453	250	248	372	453	200	20F1AND302JNONNNNN ⁽⁴⁾	7
361	397	542	300	302	453	535	250	20F1AND361JNONNNNN ⁽⁴⁾	
415	457	623	350	361	542	650	300	20F1AND415JNONNNNN ⁽⁴⁾	
477	525	716	400	361	542	650	300	20F1AND477JNONNNNN ⁽⁴⁾	

- (1) Frames 1...5 are IP20, NEMA/UL Type Open. Frames 6...7 are IP00, NEMA/UL Type Open. Frames 1...7 can be converted to IP20, NEMA/UL Type 1 with optional kit (20-750-NEMA1-Fx), where x is the frame size of the drive.
- (2) The 5th character determines Input Type; "1" = AC input with precharge and DC terminals, and "A" = AC input with precharge and no DC terminals. For DC input drives, see [DRIVES-SG001](#), the PowerFlex Common Bus Configuration Selection Guide.
- (3) The 11th character determines default Filtering and Common Mode Cap jumper configuration; "J" = Installed, and "A" = Removed.
- (4) The 12th character determines whether an internal dynamic braking IGBT is included; "A" = Internal dynamic braking transistor installed, and "N" = No internal dynamic braking transistor.

460...480V AC, Three-phase Drives (continued)

IP54, NEMA/UL Type 12

Normal Duty				Heavy Duty				Cat. No. ⁽¹⁾⁽²⁾	Frame Size
Output Amps			Hp	Output Amps			Hp		
Cont.	1 min	3 s		Cont.	1 min	3 s			
2.1	3.1	3.7	1	2.1	3.1	3.7	1	20F11GD2P1JA0NNNNN	2
3.4	5.1	6.1	2	3.4	5.1	6.1	2	20F11GD3P4JA0NNNNN	
5	7.5	9	3	5	7.5	9	3	20F11GD5P0JA0NNNNN	
8	12	14.4	5	8	12	14.4	5	20F11GD8P0JA0NNNNN	
11	16.5	19.8	7.5	11	16.5	19.8	7.5	20F11GD011JA0NNNNN	
14	15.4	21	10	11	16.5	21	7.5	20F11GD014JA0NNNNN	
22	24.2	33	15	14	24.2	33	10	20F11GD022JA0NNNNN	
27	29.7	40.5	20	22	33	40.5	15	20F11GD027JA0NNNNN	3
34	37.4	51	25	27	40.5	51	20	20F11GD034JA0NNNNN	
40	44	60	30	34	51	61.2	25	20F11GD040JA0NNNNN	
52	57.2	78	40	40	60	78	30	20F11GD052JA0NNNNN	4
65	71.5	97.5	50	52	78	97.5	40	20F11GD065JA0NNNNN	5
77	84.7	116	60	65	97.5	116	50	20F11GD077JA0NNNNN	
96	106	144	75	77	116	144	60	20F1AGD096JNONNNNN ⁽³⁾	6
125	138	188	100	96	144	188	75	20F1AGD125JNONNNNN ⁽³⁾	
156	172	234	125	125	188	234	100	20F1AGD156JNONNNNN ⁽³⁾	
186	205	279	150	156	234	281	125	20F1AGD186JNONNNNN ⁽³⁾	
248	273	372	200	186	279	372	150	20F1AGD248JNONNNNN ⁽³⁾	7
302	332	453	250	248	372	453	200	20F1AGD302JNONNNNN ⁽³⁾	
361	397	542	300	302	453	535	250	20F1AGD361JNONNNNN ⁽³⁾	
415	457	623	350	361	542	650	300	20F1AGD415JNONNNNN ⁽³⁾	

(1) The 5th character determines Input Type; "1" = AC input with precharge and DC terminals, and "A" = AC input with precharge and no DC terminals. For DC input drives, see [DRIVES-SG001](#), the PowerFlex Common Bus Configuration Selection Guide.

(2) The 11th character determines default Filtering and Common Mode Cap jumper configuration; "J" = Installed, and "A" = Removed.

(3) The 12th character determines whether an internal dynamic braking IGBT is included; "A" = Internal dynamic braking transistor installed, and "N" = No internal dynamic braking transistor.

460...480V AC, Three-phase Drives (continued)

Flange Mount (Front: IP20, NEMA/UL Type Open; Back/Heatsink: IP66, NEMA/UL Type 4X)

Note: Frame 6...7 IP00, NEMA Type Open drives can be converted to a flange mount drive (back/heatsink: IP66, NEMA/UL Type 4X) with an optional user installed flange kit (kit 20-750-FLNG4-F6 for Frame 6, and kit 20-750-FLNG4-F7 for Frame 7). See page 73 for 480V, Frame 6...7 IP00, NEMA Type Open drives.

Normal Duty				Heavy Duty				Cat. No. ⁽¹⁾⁽²⁾	Frame Size
Output Amps			Hp	Output Amps			Hp		
Cont.	1 min	3 s		Cont.	1 min	3 s			
2.1	3.1	3.7	1	2.1	3.1	3.7	1	20F11FD2P1JA0NNNNN	2
3.4	5.1	6.1	2	3.4	5.1	6.1	2	20F11FD3P4JA0NNNNN	
5	7.5	9	3	5	7.5	9.0	3	20F11FD5P0JA0NNNNN	
8	12	14.4	5	8	12	14.4	5	20F11FD8P0JA0NNNNN	
11	16.5	19.8	7.5	11	16.5	19.8	7.5	20F11FD011JA0NNNNN	
14	15.4	21	10	11	16.5	21	7.5	20F11FD014JA0NNNNN	
22	24.2	33	15	14	24.2	33	10	20F11FD022JA0NNNNN	
27	29.7	40.5	20	22	33	40.5	15	20F11FD027JA0NNNNN	3
34	37.4	51	25	27	40.5	51	20	20F11FD034JA0NNNNN	
40	44	60	30	34	51	61.2	25	20F11FD040JA0NNNNN	
52	57.2	78	40	40	60	78	30	20F11FD052JA0NNNNN	4
65	71.5	97.5	50	52	78	97.5	40	20F11FD065JA0NNNNN	
77	84.7	116	60	65	97.5	116	50	20F11FD077JA0NNNNN	5
96	106	144	75	77	116	144	60	20F11FD096JA0NNNNN	

(1) The 5th character determines Input Type; "1" = AC input with precharge and DC terminals, and "A" = AC input with precharge and no DC terminals. For DC input drives, see [DRIVES-SG001](#), the PowerFlex Common Bus Configuration Selection Guide.

(2) The 11th character determines default Filtering and Common Mode Cap jumper configuration; "J" = Installed, and "A" = Removed.

575...600V AC, Three-phase Drives

IP00/IP20, NEMA/UL Type Open⁽¹⁾

Frames 3, 4, and 5 are only 575...600V AC drives. Frames 6 and 7 are dual-voltage drives, and can be operated at 575...600 V or 660...690V AC.

Important: Frames 3, 4, and 5 must not be used in common DC input-sharing applications with Frames 6 or larger drives. For more details, contact your local Rockwell Automation sales office or your Allen-Bradley distributor.

Normal Duty				Heavy Duty				Cat. No. ⁽²⁾⁽³⁾	Frame Size
Output Amps			Hp	Output Amps			Hp		
Cont.	1 min	3 s		Cont.	1 min	3 s			
1.7	1.9	2.6	1	1.7	1.4	2.6	1	20F11NE1P7JA0NNNNN	3
2.7	3	4.1	2	1.7	2.6	4.1	1	20F11NE2P7JA0NNNNN	
3.9	4.29	5.85	3	2.7	4.1	5.9	2	20F11NE3P9JA0NNNNN	
6.1	6.7	9.2	5	3.9	5.9	9.2	3	20F11NE6P1JA0NNNNN	
9	9.9	13.5	7.5	6.1	9.2	13.5	5	20F11NE9P0JA0NNNNN	
11	12.1	16.5	10	9	13.5	16.5	7.5	20F11NE011JA0NNNNN	
17	18.7	25.5	15	11	16.5	25.5	10	20F11NE017JA0NNNNN	
22	24.2	33	20	17	25.5	33	15	20F11NE022JA0NNNNN	
27	29.7	40.5	25	22	33	40.5	20	20F11NE027JA0NNNNN	4
32	35.2	48	30	27	40.5	48.6	25	20F11NE032JA0NNNNN	
41	45.1	61.5	40	32	48	61.5	30	20F11NE041JA0NNNNN	
52	57.2	78	50	41	61.5	78	40	20F11NE052JA0NNNNN	5
12	13.2	18	10	9.1	13.7	18	7.5	20F1ANE012JNONNNNN ⁽⁴⁾	
18	19.8	27	15	12	18	27	10	20F1ANE018JNONNNNN ⁽⁴⁾	
23	25.3	34.5	20	18	27	34.5	15	20F1ANE023JNONNNNN ⁽⁴⁾	
24	26.4	36	20	22	33	39.6	20	20F1ANE024JNONNNNN ⁽⁴⁾	
28	30.8	42	25	23	34.5	42	20	20F1ANE028JNONNNNN ⁽⁴⁾	
33	36.3	49.5	30	28	42	50.4	25	20F1ANE033JNONNNNN ⁽⁴⁾	
42	46.2	63	40	33	49.5	63	30	20F1ANE042JNONNNNN ⁽⁴⁾	
53	58	80	50	42	63	80	40	20F1ANE053JNONNNNN ⁽⁴⁾	
63	69	95	60	52	78	95	50	20F1ANE063JNONNNNN ⁽⁴⁾	
77	85	116	75	63	95	116	60	20F1ANE077JNONNNNN ⁽⁴⁾	
99	109	149	100	77	116	149	75	20F1ANE099JNONNNNN ⁽⁴⁾	7
125	138	188	125	99	149	188	100	20F1ANE125JNONNNNN ⁽⁴⁾	
144	158	216	150	125	188	225	125	20F1ANE144JNONNNNN ⁽⁴⁾	
192	211	288	200	144	216	288	150	20F1ANE192JNONNNNN ⁽⁴⁾	
242	266	363	250	192	288	363	200	20F1ANE242JNONNNNN ⁽⁴⁾	
289	318	434	300	242	363	436	250	20F1ANE289JNONNNNN ⁽⁴⁾	

- (1) Frames 3...5 are IP20, NEMA/UL Type Open. Frames 6...7 are IP00, NEMA/UL Type Open. Frames 3...7 can be converted to IP20, NEMA/UL Type 1 with optional kit (20-750-NEMA1-Fx), where x is the frame size of the drive.
- (2) The 5th character determines Input Type; "1" = AC input with precharge and DC terminals, and "A" = AC input with precharge and no DC terminals. For DC input drives, see [DRIVES-SG001](#), the PowerFlex Common Bus Configuration Selection Guide.
- (3) The 11th character determines default Filtering and Common Mode Cap jumper configuration; "J" = Installed, and "A" = Removed.
- (4) The 12th character determines whether an internal dynamic braking IGBT is included; "A" = Internal dynamic braking transistor installed, and "N" = No internal dynamic braking transistor.

575...600V AC, Three-phase Drives (continued)

IP54, NEMA/UL Type 12

Frames 3, 4, and 5 are only 575...600V AC drives. Frames 6 and 7 are dual-voltage drives, and can be operated at 575...600 V or 660...690V AC.

Normal Duty				Heavy Duty				Cat. No. ⁽¹⁾⁽²⁾	Frame Size
Output Amps			Hp	Output Amps			Hp		
Cont.	1 min	3 s		Cont.	1 min	3 s			
1.7	1.9	2.6	1	1.7	1.4	2.6	1	20F11GE1P7JA0NNNNN	3
2.7	3	4.1	2	1.7	2.6	4.1	1	20F11GE2P7JA0NNNNN	
3.9	4.29	5.85	3	2.7	4.1	5.9	2	20F11GE3P9JA0NNNNN	
6.1	6.7	9.2	5	3.9	5.9	9.2	3	20F11GE6P1JA0NNNNN	
9	9.9	13.5	7.5	6.1	9.2	13.5	5	20F11GE9POJA0NNNNN	
11	12.1	16.5	10	9	13.5	16.5	7.5	20F11GE011JA0NNNNN	
17	18.7	25.5	15	11	16.5	25.5	10	20F11GE017JA0NNNNN	
22	24.2	33	20	17	25.5	33	15	20F11GE022JA0NNNNN	
27	29.7	40.5	25	22	33	40.5	20	20F11GE027JA0NNNNN	4
32	35.2	48	30	27	40.5	48.6	25	20F11GE032JA0NNNNN	
41	45.1	61.5	40	32	48	61.5	30	20F11GE041JA0NNNNN	5
12	13.2	18	10	9.1	13.7	18	7.5	20F1AGE012JNONNNNN ⁽³⁾	6
18	19.8	27	15	12	18	27	10	20F1AGE018JNONNNNN ⁽³⁾	
23	25.3	34.5	20	18	27	34.5	15	20F1AGE023JNONNNNN ⁽³⁾	
24	26.4	36	20	22	33	39.6	20	20F1AGE024JNONNNNN ⁽³⁾	
28	30.8	42	25	23	34.5	42	20	20F1AGE028JNONNNNN ⁽³⁾	
33	36.3	49.5	30	28	42	50.4	25	20F1AGE033JNONNNNN ⁽³⁾	
42	46.2	63	40	33	49.5	63	30	20F1AGE042JNONNNNN ⁽³⁾	
53	58	80	50	42	63	80	40	20F1AGE053JNONNNNN ⁽³⁾	
63	69	95	60	52	78	95	50	20F1AGE063JNONNNNN ⁽³⁾	
77	85	116	75	63	95	116	60	20F1AGE077JNONNNNN ⁽³⁾	
99	109	149	100	77	116	149	75	20F1AGE099JNONNNNN ⁽³⁾	
125	138	188	125	99	149	188	100	20F1AGE125JNONNNNN ⁽³⁾	
144	158	216	150	125	188	225	125	20F1AGE144JNONNNNN ⁽³⁾	
192	211	288	200	144	216	288	150	20F1AGE192JNONNNNN ⁽³⁾	7
242	266	363	250	192	288	363	200	20F1AGE242JNONNNNN ⁽³⁾	
289	318	434	300	242	363	436	250	20F1AGE289JNONNNNN ⁽³⁾	

(1) The 5th character determines Input Type; "1" = AC input with precharge and DC terminals, and "A" = AC input with precharge and no DC terminals. For DC input drives, see [DRIVES-SG001](#), the PowerFlex Common Bus Configuration Selection Guide.

(2) The 11th character determines default Filtering and Common Mode Cap jumper configuration; "J" = Installed, and "A" = Removed.

(3) The 12th character determines whether an internal dynamic braking IGBT is included; "A" = Internal dynamic braking transistor installed, and "N" = No internal dynamic braking transistor.

600V AC, Three-phase Drives (continued)

Flange Mount (Front: IP20, NEMA/UL Type Open; Back/Heatsink: IP66, NEMA/UL Type 4X)

Frames 3, 4, and 5 are only 600V AC drives. Frames 6 and 7 are dual-voltage drives, and can be operated at 600 V or 690V AC.

Important: Frames 3, 4, and 5 must not be used in common DC input-sharing applications with Frames 6 or larger drives. For more details, contact your local Rockwell Automation sales office or your Allen-Bradley distributor.

Note: Frame 6...7 IP00, NEMA Type Open drives can be converted to a flange mount drive (back/heatsink: IP66, NEMA/UL Type 4X) with an optional user installed flange kit (kit 20-750-FLNG4-F6 for Frame 6, and kit 20-750-FLNG4-F7 for Frame 7). See page 76 for 600V, Frame 6...7 IP00, NEMA Type Open drives.

Normal Duty				Heavy Duty				Cat. No. ⁽¹⁾⁽²⁾	Frame Size
Output Amps			Hp	Output Amps			Hp		
Cont.	1 min	3 s		Cont.	1 min	3 s			
1.7	1.9	2.6	1	1.7	1.4	2.6	1	20F11FE1P7JA0NNNNN	3
2.7	3	4.1	2	1.7	2.6	4.1	1	20F11FE2P7JA0NNNNN	
3.9	4.29	5.85	3	2.7	4.1	5.9	2	20F11FE3P9JA0NNNNN	
6.1	6.7	9.2	5	3.9	5.9	9.2	3	20F11FE6P1JA0NNNNN	
9	9.9	13.5	7.5	6.1	9.2	13.5	5	20F11FE9P0JA0NNNNN	
11	12.1	16.5	10	9	13.5	16.5	7.5	20F11FE011JA0NNNNN	
17	18.7	25.5	15	11	16.5	25.5	10	20F11FE017JA0NNNNN	
22	24.2	33	20	17	25.5	33	15	20F11FE022JA0NNNNN	
27	29.7	40.5	25	22	33	40.5	20	20F11FE027JA0NNNNN	4
32	35.2	48	30	27	40.5	48.6	25	20F11FE032JA0NNNNN	
41	45.1	61.5	40	32	48	61.5	30	20F11FE041JA0NNNNN	5
52	57.2	78.0	50	41	61.5	78	40	20F11FE052JA0NNNNN	

(1) The 5th character determines Input Type; "1" = AC input with precharge and DC terminals, and "A" = AC input with precharge and no DC terminals. For DC input drives, see [DRIVES-SG001](#), the PowerFlex Common Bus Configuration Selection Guide.

(2) The 11th character determines default Filtering and Common Mode Cap jumper configuration; "J" = Installed, and "A" = Removed.

690V AC, Three-phase Drives

IP00/IP20, NEMA/UL Type Open⁽¹⁾

Normal Duty				Heavy Duty				Cat. No. ⁽²⁾⁽³⁾	Frame Size
Output Amps			kW	Output Amps			kW		
Cont.	1 min	3 s		Cont.	1 min	3 s			
12	13.2	18	7.5	9	13.5	18	5.5	20F1ANF012JNONNNNN ⁽⁴⁾	6
15	16.5	22.5	11	12	18	22.5	7.5	20F1ANF015JNONNNNN ⁽⁴⁾	
20	22	30	15	15	22.5	30	11	20F1ANF020JNONNNNN ⁽⁴⁾	
23	25.3	34.5	18.5	20	30	36	15	20F1ANF023JNONNNNN ⁽⁴⁾	
30	33	45	22	23	34.5	45	18.5	20F1ANF030JNONNNNN ⁽⁴⁾	
34	37.4	51	30	30	45	54	22	20F1ANF034JNONNNNN ⁽⁴⁾	
46	50.6	69	37	34	51	69	30	20F1ANF046JNONNNNN ⁽⁴⁾	
50	55	75	45	46	69	83	37	20F1ANF050JNONNNNN ⁽⁴⁾	
61	67	92	55	50	75	92	45	20F1ANF061JNONNNNN ⁽⁴⁾	
82	90	123	75	61	92	123	55	20F1ANF082JNONNNNN ⁽⁴⁾	
98	108	147	90	82	123	148	75	20F1ANF098JNONNNNN ⁽⁴⁾	
119	131	179	110	98	147	179	90	20F1ANF119JNONNNNN ⁽⁴⁾	
142	156	213	132	119	179	214	110	20F1ANF142JNONNNNN ⁽⁴⁾	
171	188	257	160	142	213	257	132	20F1ANF171JNONNNNN ⁽⁴⁾	
212	233	318	200	171	257	318	160	20F1ANF212JNONNNNN ⁽⁴⁾	
263	289	395	250	212	318	395	200	20F1ANF263JNONNNNN ⁽⁴⁾	

(1) Frames 6...7 are IP00, NEMA/UL Type Open. Frames 1...7 can be converted to IP20, NEMA/UL Type 1 with optional kit (20-750-NEMA1-Fx), where x is the frame size of the drive.

(2) The 5th character determines Input Type; "1" = AC input with precharge and DC terminals, and "A" = AC input with precharge and no DC terminals. For DC input drives, see [DRIVES-SG001](#), the PowerFlex Common Bus Configuration Selection Guide.

(3) The 11th character determines default Filtering and Common Mode Cap jumper configuration; "J" = Installed, and "A" = Removed.

(4) The 12th character determines whether an internal dynamic braking IGBT is included; "A" = Internal dynamic braking transistor installed, and "N" = No internal dynamic braking transistor.

690V AC, Three-phase Drives (continued)

IP54, NEMA/UL Type 12

Normal Duty				Heavy Duty				Cat. No. ⁽¹⁾⁽²⁾	Frame Size
Outputs Amp			kW	Output Amps			kW		
Cont.	1 min	3 s		Cont.	1 min	3 s			
12	13.2	18	7.5	9	13.5	18	5.5	20F1AGF012JNONNNNN ⁽³⁾	6
15	16.5	22.5	11	12	18	22.5	7.5	20F1AGF015JNONNNNN ⁽³⁾	
20	22	30	15	15	22.5	30	11	20F1AGF020JNONNNNN ⁽³⁾	
23	25.3	34.5	18.5	20	30	36	15	20F1AGF023JNONNNNN ⁽³⁾	
30	33	45	22	23	34.5	45	18.5	20F1AGF030JNONNNNN ⁽³⁾	
34	37.4	51	30	30	45	54	22	20F1AGF034JNONNNNN ⁽³⁾	
46	50.6	69	37	34	51	69	30	20F1AGF046JNONNNNN ⁽³⁾	
50	55	75	45	46	69	83	37	20F1AGF050JNONNNNN ⁽³⁾	
61	67	92	55	50	75	92	45	20F1AGF061JNONNNNN ⁽³⁾	
82	90	123	75	61	92	123	55	20F1AGF082JNONNNNN ⁽³⁾	
98	108	147	90	82	123	148	75	20F1AGF098JNONNNNN ⁽³⁾	
119	131	179	110	98	147	179	90	20F1AGF119JNONNNNN ⁽³⁾	
142	156	213	132	119	179	214	110	20F1AGF142JNONNNNN ⁽³⁾	
171	188	257	160	142	213	257	132	20F1AGF171JNONNNNN ⁽³⁾	
212	233	318	200	171	257	318	160	20F1AGF212JNONNNNN ⁽³⁾	
263	289	395	250	212	318	395	200	20F1AGF263JNONNNNN ⁽³⁾	

(1) The 5th character determines Input Type; "1" = AC input with precharge and DC terminals, and "A" = AC input with precharge and no DC terminals. For DC input drives, see [DRIVES-SG001](#), the PowerFlex Common Bus Configuration Selection Guide.

(2) The 11th character determines default Filtering and Common Mode Cap jumper configuration; "J" = Installed, and "A" = Removed.

(3) The 12th character determines whether an internal dynamic braking IGBT is included; "A" = Internal dynamic braking transistor installed, and "N" = No internal dynamic braking transistor.

Flange Mount (Front: IP20, NEMA/UL Type Open; Back/Heatsink: IP66, NEMA/UL Type 4X)

Note: Frame 6...7 IP00, NEMA Type Open drives can be converted to a flange mount drive (Back/Heatsink: IP66, NEMA/UL Type 4X) with an optional user installed flange kit (20-750-FLNG4-F6 for Frame 6, and 20-750-FLNG4-F7 for Frame 7).

See page 79 for 690V, Frame 6...7 IP00, NEMA Type Open drives.

Approximate Dimensions and Weights

Dimensions are in mm (in.) - weights are in kg (lb)

IP00/IP20, NEMA/UL Type Open

Frame	H	W	D	Weight ⁽¹⁾
1	400.5 (15.77)	110 (4.33)	211 (8.31)	6 (12.75)
2	424.2 (16.7)	134.5 (5.3)	212 (8.35)	7.8 (17.2)
3	454 (17.87)	190 (7.48)		11.8 (26.1)
4	474 (18.66)	222 (8.74)		13.6 (30)
5	550 (21.65)	270 (10.63)		20.4 (45)
6	665.5 (26.2)	308 (12.13)	346.4 (13.64)	38.6 (85)
7	881.5 (34.7)	430 (16.93)	349.6 (13.76)	72.6... 108.9 (160... 240)

(1) Weights are approximate. Refer to [750-TD001](#), the PowerFlex 750-Series Technical Data, for detailed weight information.

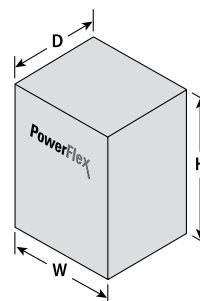

IP54, NEMA/UL Type 12

Frame	H	W	D	Weight ⁽¹⁾
2	543.2 (21.39)	215.3 (8.48)	222.2 (8.75)	8 (17)
3	551 (21.69)	268 (10.55)	220.1 (8.67)	12 (26)
4	571 (22.48)	300 (11.81)		14 (30)
5	647 (25.47)	348.0 (13.7)		20 (45)
6	1298.3 (51.11)	609.4 (24)	464.7 (18.3)	91 (200)
7	1614 (63.54)			162 (357)

(1) Weights are approximate. Refer to [750-TD001](#), the PowerFlex 750-Series Technical Data, for detailed weight information.

Flange Mount

Frame	H	W	D1	D2	Weight ⁽¹⁾
2	481.8 (18.97)	206.2 (8.12)	148.3 (5.84)	63.7 (2.51)	8 (17)
3	515 (20.28)	260 (10.24)	127.4 (5.02)	84.6 (3.33)	12 (26)
4	535 (21.06)	292 (11.5)			14 (30)
5	611 (24.06)	340 (13.39)			20 (45)
6	665.5 (26.2)	308 (12.13)	208.4 (8.2)	138 (5.43)	38 (84)
7	875 (34.45)	430 (16.93)			96 (212)

(1) Weights are approximate. Refer to [750-TD001](#), the PowerFlex 750-Series Technical Data, for detailed weight information.

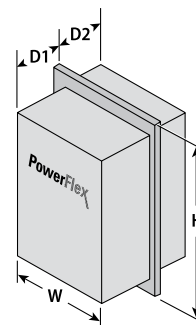

PowerFlex 755 AC Drive

0.37...1500 kW/1...2000 Hp in voltages from 200...690V

Designed for flexibility, connectivity and productivity, the PowerFlex 755 AC drive provides ease of use and high performance for a wide variety of motor control applications. Ideal for machines that benefit from safety options, application flexibility, and packaging designed to meet a variety of environmental conditions, the PowerFlex 755 drive offers more selection for control, communications, safety, and supporting hardware options than any other drives in its class.

The PowerFlex 755 AC drive can be configured and programmed by using motions instructions within the Studio 5000 environment that are shared with Kinetix servo drives. This common user experience helps to reduce complexity and save valuable engineering time.

PowerFlex 755 at a Glance

Ratings	200...240V 0.37...132 kW / 0.5...200 Hp / 2.2...477 A 380...480V 0.75...1400 kW / 1.0...2000 Hp / 2.1...2330 A 600V 1.0...1500 Hp / 1.7...1530 A 690V 7.5...1500 kW / 12...1485 A	
Motor Control	<ul style="list-style-type: none"> V/Hz Control Sensorless Vector Control Vector Control with FORCE Technology (with and without encoder) 	<ul style="list-style-type: none"> Surface Mount Permanent Magnet: Frames 1...7 (with and without encoder) Frames 8...10 (with encoder) Interior Permanent Magnet: Frames 1...7 (with and without encoder) Frames 8...10 (with encoder)
Enclosures	<ul style="list-style-type: none"> IP00/IP20, NEMA/UL Type Open Flange Mount IP54/NEMA/UL Type 12 	<ul style="list-style-type: none"> IP20, NEMA/UL Type 1 (MCC Style Cabinet) IP54, NEMA Type 12 (MCC Style Cabinet)
Safety	<ul style="list-style-type: none"> Hardwired Safe Torque Off SIL3, PLc, CAT 3 Hardwired Safe Speed Monitor SIL3, PLc, CAT 4 	<ul style="list-style-type: none"> Networked Safe Torque Off SIL3, PLc, CAT 3
Additional Features	<ul style="list-style-type: none"> Built-in EtherNet/IP Port Automatic Device Configuration Program with motion instructions in Studio 5000 Logix Designer™ Software Predictive Diagnostics Adjustable Voltage Control Five option slots for I/O, feedback, safety, auxiliary control power, communications Accurate positioning with PCAM, Indexer, Electronic Gearing, and speed/position profiling Incremental, Absolute and High Resolution feedback supported 	<ul style="list-style-type: none"> TorqProve for lifting applications Pump Jack and Pump Off for oil well applications Pump and Traverse for fiber applications Conformal Coating DC Link Choke AC line fuses included with Frame 8...10 drives Roll-out design for Frame 8...10 drives
Certifications	<ul style="list-style-type: none"> ABS AC156 Seismic Standards ATEX⁽¹⁾ cULus CE EAC KCC 	<ul style="list-style-type: none"> Lloyd's Register RCM RINA RoHS SEMI F47 TÜV FS⁽²⁾
Options	See pages 126...147	

(1) Certification requires 11-series I/O and ATEX daughter card options.

(2) Certification applies to 20-750-S, 20-750-S1, and 20-750-S3 safety options when installed in drive.

Branch circuit protection supplied separately

Isolation Transformers and Input Line Reactors are available. See pages 137...147.

Integral EMC Filter. External Common Mode Choke is available. See page 130 and 1321 Power Conditioning Products Technical Data, publication 1321-TD001, for additional information.



Output Reactors, Terminators and Reflected Wave Devices are optional. See pages 135...147.

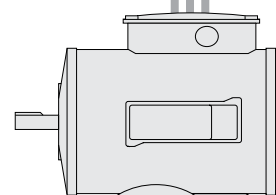

Safety, feedback, and other drive options are available. See pages 129...132.

1 LCD HIM with multi-language support in scrolling text available as optional accessory. See page 126 for other options.

2 Communications: Embedded EtherNet/IP. See page 126 for additional options.

3 Embedded I/O: 1 Digital Input. See page 126 for other options.

4 Integral brake transistor on Frames 1...5, optional on Frames 6...7. Resistors are available. See page 135.

PowerFlex 755 Wall Mount Drives

PowerFlex 755 wall mount drives have a power range from 0.75 kW / 1 Hp to 270 kW / 400 Hp and are available in several factory and field installable enclosure options to meet most environmental requirements.

The standard enclosure is optimized for cabinet installation and rated at IP00/IP20, NEMA/UL Type Open. Wall mount drives can be converted to IP20, NEMA/UL Type 1 with an optional kit containing a debris hood and conduit plate. A factory enclosure option is also available with extra protection (IP54, NEMA Type 12) for harsh environments.

Flange mount drives are available via a factory option (Frames 1...5) or field installable kits (Frames 6...7) and are designed to reduce panel cooling requirements by mounting the drive heatsink outside the cabinet.

A DC link choke is included on all frames and internal brake transistor in standard on Frames 1...5 and optional on Frames 6...7.



PowerFlex 755 Floor Mount Drives

PowerFlex 755 floor mount drives have a power range from 200 kW / 250 Hp to 1400 kW / 2000 Hp, and offer multiple duty ratings to provide flexibility for different application requirements. One drive can provide three different motor current ratings. For example a 480 A drive can run a 400 Hp motor in light duty, a 350 Hp motor in normal duty, and a 300 Hp motor in heavy duty.

- Light Duty = 110% of motor rated current for 60 seconds
- Normal Duty = 110% of motor rated current for 60 seconds/150% of motor rated current for 3 seconds
- Heavy Duty = 150% of motor rated current for 60 seconds/180% of motor rated current for 3 seconds

Other power options from the factory include disconnect, reactor, contactor, integrated MCC bus for direct connection to CENTERLINE MCC, auxiliary transformer or wiring bay.



IP54, NEMA Type 12 Drive and Options (2500 MCC Style Cabinet)
(Frame 9 shown)

Includes: DC link choke, Integrated AC line fuses, roll-out design, exhaust hood, and option bay for control/protection devices.

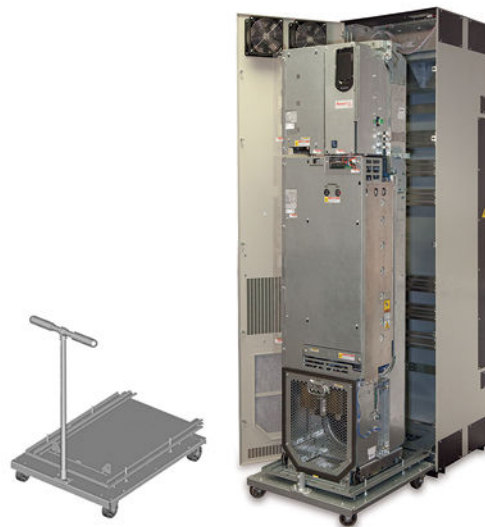

Roll-out Design
(Frame 8 shown)

A roll-out cart is required for Frame 8...10 drives and Frame 9...10 optional bay chassis. The cart has an adjustable Curb Height of 0...182 mm (0...7.2 in.) and curb offset/reach of 0...114 mm (0...4.5 in.). See page 131 for ordering information.

Additional Information

PowerFlex 750-Series Brochure, publication [750-BR001](#)
 PowerFlex 750-Series Technical Data, publication [750-TD001](#)
 PowerFlex 750-Series Quick Start Guide, publication [750-QS001](#)

Catalog Number Explanation

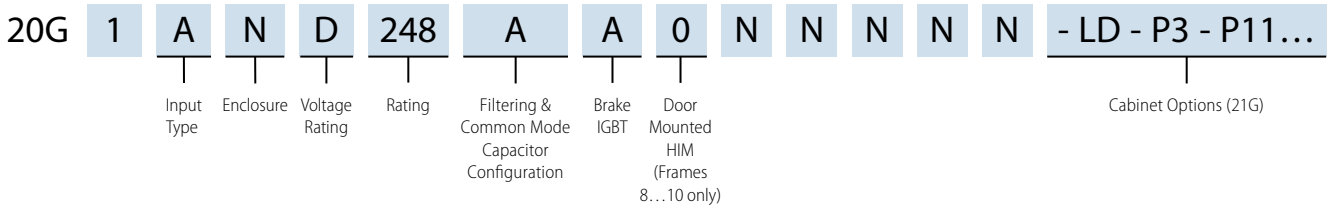

Product Selection

200...240V AC, Three-phase Drives (Available mid-2017)

IP00/IP20, NEMA/UL Type Open⁽¹⁾

Normal Duty					Heavy Duty					Cat. No. ⁽³⁾⁽⁴⁾	Frame Size
Output Amps: 240V (208V) ⁽²⁾					Output Amps: 240V (208V) ⁽²⁾						
Cont.	1 min	3 s	HP	kW	Cont.	1 min	3 s	HP	kW		
2.2 (2.5)	2.4 (2.7)	3.3 (3.7)	0.5	0.37	2.2 (2.5)	3.3 (3.7)	3.9 (4.5)	0.5	0.37	20G11RB2P2JA0NNNNN	1
4.2 (4.8)	4.6 (5.2)	6.3 (7.2)	1	0.75	2.2 (2.5)	4.6 (5.2)	6.3 (7.2)	0.5	0.37	20G11RB4P2JA0NNNNN	
6.8 (7.8)	7.4 (8.5)	10.2 (11.7)	2	1.5	4.2 (4.8)	7.4 (8.5)	10.2 (11.7)	1	0.75	20G11RB6P8JA0NNNNN	
9.6 (11)	10.5 (12.1)	14.4 (16.5)	3	2.2	6.8 (7.8)	10.5 (12.1)	14.4 (16.5)	2	1.5	20G11RB9P6JA0NNNNN	
15.3 (15.3)	16.8 (16.8)	22.9 (22.9)	5	4	9.6 (11)	16.8 (16.8)	22.9 (22.9)	3	2.2	20G11RB015JA0NNNNN	
2.2 (2.5)	3.3 (3.7)	3.9 (4.5)	0.5	0.37	2.2 (2.5)	3.3 (3.7)	3.9 (4.5)	0.5	0.37	20G11NB2P2JA0NNNNN	2
4.2 (4.8)	6.3 (7.2)	7.5 (8.6)	1	0.75	4.2 (4.8)	6.3 (7.2)	7.5 (8.6)	1	0.75	20G11NB4P2JA0NNNNN	
6.8 (7.8)	10.2 (11.7)	12.2 (14)	2	1.5	6.8 (7.8)	10.2 (11.7)	12.2 (14)	2	1.5	20G11NB6P8JA0NNNNN	
9.6 (11)	14.4 (16.5)	17.2 (19.8)	3	2.2	9.6 (11)	14.4 (16.5)	17.2 (19.8)	3	2.2	20G11NB9P6JA0NNNNN	
15.3 (17.5)	16.8 (19.2)	22.9 (26.2)	5	4	9.6 (11)	16.8 (19.2)	22.9 (26.2)	3	2.2	20G11NB015JA0NNNNN	
22 (22)	24.2 (24.2)	33 (33)	7.5	5.5	15.3 (17.5)	24.2 (24.2)	33 (33)	5	4	20G11NB022JA0NNNNN	3
28 (32.2)	30.8 (35.4)	42 (48.3)	10	7.5	22 (22)	33 (35.4)	42 (48.3)	7.5	5.5	20G11NB028JA0NNNNN	
42 (43)	46.2 (47.3)	63 (64.5)	15	11	28 (32.2)	46.2 (48.3)	63 (64.5)	10	7.5	20G11NB042JA0NNNNN	
54 (60)	59.4 (66)	81 (90)	20	15	42 (43)	63 (64.5)	81 (90)	15	11	20G11NB054JA0NNNNN	4
70 (78.2)	77 (86)	105 (117)	25	18.5	54 (60)	81 (90)	105 (117)	20	15	20G11NB070JA0NNNNN	5
80 (92)	88 (101)	120 (138)	30	22	70 (78.2)	105 (117)	126 (140)	25	18.5	20G11NB080JA0NNNNN	

(1) Frames 1...5 are IP20, NEMA/UL Type Open. Frames 6...7 are IP00, NEMA/UL Type Open. Frames 1...7 can be converted to IP20, NEMA/UL Type 1 with optional kit (20-750-NEMA1-Fx), where x is the frame size of the drive.
 (2) Drives must be programmed to lower voltage to obtain the currents shown in parentheses.
 (3) The 5th character determines Input Type; "1" = AC input with precharge and DC terminals, and "A" = AC input with precharge and no DC terminals. For DC input drives, see [DRIVES-SG001](#), the PowerFlex Common Bus Configuration Selection Guide.
 (4) The 11th character determines default Filtering and Common Mode Cap jumper configuration; "J" = Installed, and "A" = Removed.

(table continues on next page)

200...240V AC, Three-phase Drives (Available mid-2017), (continued)

IP00/IP20, NEMA/UL Type Open (continued)⁽¹⁾

Normal Duty					Heavy Duty					Cat. No. ⁽³⁾⁽⁴⁾	Frame Size
Output Amps: 240V (208V) ⁽²⁾			Hp	kW	Output Amps: 240V (208V) ⁽²⁾			Hp	kW		
Cont.	1 min	3 s			Cont.	1 min	3 s				
104 (120)	114 (132)	156 (180)	40	30	80 (92)	120 (138)	156 (180)	30	22	20G1ANB104JNONNNNN ⁽⁵⁾	6
130 (150)	143 (165)	195 (225)	50	37	104 (120)	156 (180)	195 (225)	40	30	20G1ANB130JNONNNNN ⁽⁵⁾	
154 (177)	169 (194)	231 (265)	60	45	130 (150)	195 (225)	234 (270)	50	37	20G1ANB154JNONNNNN ⁽⁵⁾	
192 (221)	211 (243)	288 (331)	75	55	154 (177)	231 (265)	288 (331)	60	45	20G1ANB192JNONNNNN ⁽⁵⁾	
260 (260)	286 (286)	390 (390)	100	66	192 (221)	288 (331)	390 (390)	75	55	20G1ANB260JNONNNNN ⁽⁵⁾	
312 (359)	343 (394)	468 (538)	125	90	260 (260)	390 (394)	468 (538)	100	66	20G1ANB312JNONNNNN ⁽⁵⁾	7
360 (414)	396 (455)	540 (621)	150	110	312 (359)	468 (538)	561 (646)	125	90	20G1ANB360JNONNNNN ⁽⁵⁾	
477 (477)	524 (524)	715 (715)	200	132	312 (359)	468 (538)	561 (646)	125	90	20G1ANB477JNONNNNN ⁽⁵⁾	

- (1) Frames 1...5 are IP20, NEMA/UL Type Open. Frames 6...7 are IP00, NEMA/UL Type Open. Frames 1...7 can be converted to IP20, NEMA/UL Type 1 with optional kit (20-750-NEMA1-Fx), where x is the frame size of the drive.
- (2) Drives must be programmed to lower voltage to obtain the currents shown in parentheses.
- (3) The 5th character determines Input Type; "1" = AC input with precharge and DC terminals, and "A" = AC input with precharge and no DC terminals. For DC input drives, see [DRIVES-SG001](#), the PowerFlex Common Bus Configuration Selection Guide.
- (4) The 11th character determines default Filtering and Common Mode Cap jumper configuration; "J" = Installed, and "A" = Removed.
- (5) The 12th character determines whether an internal dynamic braking IGBT is included; "A" = Internal dynamic braking transistor installed, and "N" = No internal dynamic braking transistor.

IP54, NEMA/UL Type 12

Normal Duty					Heavy Duty					Cat. No. ⁽²⁾⁽³⁾	Frame Size
Output Amps: 240V (208V) ⁽¹⁾			HP	kW	Output Amps: 240V (208V) ⁽¹⁾			HP	kW		
Cont.	1 min	3 s			Cont.	1 min	3 s				
2.2 (2.5)	3.3 (3.8)	4 (4.5)	0.5	0.37	2.2 (2.5)	3.3 (3.7)	3.9 (4.5)	0.5	0.37	20G11GB2P2JA0NNNNN	2
4.2 (4.8)	6.3 (7.2)	7.5 (8.6)	1	0.75	4.2 (4.8)	6.3 (7.2)	7.5 (8.6)	1	0.75	20G11GB4P2JA0NNNNN	
6.8 (7.8)	10.2 (11.7)	12.2 (14)	2	1.5	6.8 (7.8)	10.2 (11.7)	12.2 (14)	2	1.5	20G11GB6P8JA0NNNNN	
9.6 (11)	14.4 (16.5)	17.2 (19.8)	3	2.2	9.6 (11)	14.4 (16.5)	17.2 (19.8)	3	2.2	20G11GB9P6JA0NNNNN	
15.3 (17.5)	16.8 (19.2)	22.9 (26.2)	5	4	9.6 (11)	16.8 (19.2)	22.9 (26.2)	3	2.2	20G11GB015JA0NNNNN	
22 (22)	24.2 (24.2)	33 (33)	7.5	5.5	15.3 (17.5)	24.2 (24.2)	33 (33)	5	4	20G11GB022JA0NNNNN	3
28 (32.2)	30.8 (35.4)	42 (48.3)	10	7.5	22 (22)	33 (35.4)	42 (48.3)	7.5	5.5	20G11GB028JA0NNNNN	
42 (43)	46.2 (47.3)	63 (64.5)	15	11	28 (32.2)	46.2 (48.3)	63 (64.5)	10	7.5	20G11GB042JA0NNNNN	
54 (60)	59.4 (66)	81 (90)	20	15	42 (43)	63 (64.5)	81 (90)	15	11	20G11GB054JA0NNNNN	4
70 (78.2)	77 (86)	105 (117)	25	18.5	54 (60)	81 (90)	105 (117)	20	15	20G11GB070JA0NNNNN	5
80 (92)	88 (101)	120 (138)	30	22	70 (78.2)	105 (117)	126 (140)	25	18.5	20G1AGB080JNONNNNN ⁽⁴⁾	6
104 (120)	114 (132)	156 (180)	40	30	80 (92)	120 (138)	156 (180)	30	22	20G1AGB104JNONNNNN ⁽⁴⁾	
130 (150)	143 (165)	195 (225)	50	37	104 (120)	156 (180)	195 (225)	40	30	20G1AGB130JNONNNNN ⁽⁴⁾	
154 (177)	169 (194)	231 (265)	60	45	130 (150)	195 (225)	234 (270)	50	37	20G1AGB154JNONNNNN ⁽⁴⁾	
192 (221)	211 (243)	288 (331)	75	55	154 (177)	231 (265)	288 (331)	60	45	20G1AGB192JNONNNNN ⁽⁴⁾	
260 (260)	286 (286)	390 (390)	100	66	192 (221)	288 (331)	390 (390)	75	55	20G1AGB260JNONNNNN ⁽⁴⁾	7
312 (359)	343 (394)	468 (538)	125	90	260 (260)	390 (394)	468 (538)	100	66	20G1AGB312JNONNNNN ⁽⁴⁾	
360 (414)	396 (455)	540 (621)	150	110	312 (359)	468 (538)	561 (646)	125	90	20G1AGB360JNONNNNN ⁽⁴⁾	

- (1) Drive must be programmed to lower voltage to obtain the currents shown in parentheses.
- (2) The 5th character determines Input Type; "1" = AC input with precharge and DC terminals, and "A" = AC input with precharge and no DC terminals. For DC input drives, see [DRIVES-SG001](#), the PowerFlex Common Bus Configuration Selection Guide.
- (3) The 11th character determines default Filtering and Common Mode Cap jumper configuration; "J" = Installed, and "A" = Removed.
- (4) The 12th character determines whether an internal dynamic braking IGBT is included; "A" = Internal dynamic braking transistor installed, and "N" = No internal dynamic braking transistor.

200...240V AC, Three-phase Drives (Available mid-2017), (continued)

Flange Mount (Front: IP20, NEMA/UL Type Open; Back/Heatsink: IP66, NEMA/UL Type 4X)

Note: Frame 6...7 IP00, NEMA Type Open drives can be converted to a flange mount drive (Back/Heatsink: IP66, NEMA/UL Type 4X) with an optional user installed flange kit (20-750-FLNG4-F6 for Frame 6, and 20-750-FLNG4-F7 for Frame 7). See page 84 for 200...240V, Frame 6...7 IP00, NEMA Type Open drives.

Normal Duty					Heavy Duty					Cat. No. ⁽²⁾⁽³⁾	Frame Size
Output Amps: 240V (208V) ⁽¹⁾			HP	kW	Output Amps: 240V (208V) ⁽¹⁾			HP	kW		
Cont.	1 min	3 s			Cont.	1 min	3 s				
2.2 (2.5)	3.3 (3.7)	3.9 (4.5)	0.5	0.37	2.2 (2.5)	3.3 (3.7)	3.9 (4.5)	0.5	0.37	20G11FB2P2JA0NNNNN	2
4.2 (4.8)	6.3 (7.2)	7.5 (8.6)	1	0.75	4.2 (4.8)	6.3 (7.2)	7.5 (8.6)	1	0.75	20G11FB4P2JA0NNNNN	
6.8 (7.8)	10.2 (11.7)	12.2 (14)	2	1.5	6.8 (7.8)	10.2 (11.7)	12.2 (14)	2	1.5	20G11FB6P8JA0NNNNN	
9.6 (11)	14.4 (16.5)	17.2 (19.8)	3	2.2	9.6 (11)	14.4 (16.5)	17.2 (19.8)	3	2.2	20G11FB9P6JA0NNNNN	
15.3 (17.5)	16.8 (19.2)	22.9 (26.2)	5	4	9.6 (11)	16.8 (19.2)	22.9 (26.2)	3	2.2	20G11FB015JA0NNNNN	
22 (22)	24.2 (24.2)	33 (33)	7.5	5.5	15.3 (17.5)	24.2 (24.2)	33 (33)	5	4	20G11FB022JA0NNNNN	
28 (32.2)	30.8 (35.4)	42 (48.3)	10	7.5	22 (22)	33 (35.4)	42 (48.3)	7.5	5.5	20G11FB028JA0NNNNN	3
42 (43)	46.2 (47.3)	63 (64.5)	15	11	28 (32.2)	46.2 (48.3)	63 (64.5)	10	7.5	20G11FB042JA0NNNNN	
54 (60)	59.4 (66)	81 (90)	20	15	42 (43)	63 (64.5)	81 (90)	15	11	20G11FB054JA0NNNNN	4
70 (78.2)	77 (86)	105 (117)	25	18.5	54 (60)	81 (90)	105 (117)	20	15	20G11FB070JA0NNNNN	5
80 (92)	88 (101)	120 (138)	30	22	70 (78.2)	105 (117)	126 (140)	25	18.5	20G11FB080JA0NNNNN	

(1) Drive must be programmed to lower voltage to obtain the currents shown in parentheses.

(2) The 5th character determines Input Type; "1" = AC input with precharge and DC terminals, and "A" = AC input with precharge and no DC terminals. For DC input drives, see [DRIVES-SG001](#), the PowerFlex Common Bus Configuration Selection Guide.

(3) The 11th character determines default Filtering and Common Mode Cap jumper configuration; "J" = Installed, and "A" = Removed.

380...400V AC, Three-phase Drives

IP00/IP20, NEMA/UL Type Open⁽¹⁾

Light Duty ⁽²⁾			Normal Duty				Heavy Duty				Cat. No. ⁽³⁾⁽⁴⁾	Frame Size
Output Amps		kW	Output Amps			kW	Output Amps			kW		
Cont.	1 min		Cont.	1 min	3 s		Cont.	1 min	3 s			
—	—	—	2.1	2.3	3.2	0.75	1.3	2.3	3.2	0.37	20G11RC2P1JAONNNNN	1
			3.5	3.9	5.3	1.5	2.1	3.9	5.3	0.75	20G11RC3P5JAONNNNN	
			5	5.5	7.5	2.2	3.5	5.5	7.5	1.5	20G11RC5P0JAONNNNN	
			8.7	9.6	13.1	4	5	9.6	13.1	2.2	20G11RC8P7JAONNNNN	
			11.5	13.1	17.3	5.5	8.7	13.1	17.3	4	20G11RC011JAONNNNN	
			15.4	16.9	23.1	7.5	11.5	17.2	23.1	5.5	20G11RC015JAONNNNN	2
			2.1	3.1	3.7	0.75	2.1	3.1	3.7	0.75	20G11NC2P1JAONNNNN	
			3.5	5.2	6.3	1.5	3.5	5.2	6.3	1.5	20G11NC3P5JAONNNNN	
			5	7.5	9	2.2	5	7.5	9	2.2	20G11NC5P0JAONNNNN	
			8.7	13	15.6	4	8.7	13	15.6	4	20G11NC8P7JAONNNNN	
			11.5	17.2	20.7	5.5	11.5	17.2	20.7	5.5	20G11NC011JAONNNNN	3
			15.4	16.9	23.1	7.5	11.5	17.2	23.1	5.5	20G11NC015JAONNNNN	
			22	24.2	33	11	15.4	24.2	33	7.5	20G11NC022JAONNNNN	
			30	33	45	15	22	33	45	11	20G11NC030JAONNNNN	
			37	40.7	55.5	18.5	30	45	55.5	15	20G11NC037JAONNNNN	
			43	47.3	64.5	22	37	55.5	66.6	18.5	20G11NC043JAONNNNN	4
			60	66	90	30	43	66	90	22	20G11NC060JAONNNNN	
			72	79.2	108	37	60	90	108	30	20G11NC072JAONNNNN	
			85	93.5	128	45	72	108	130	37	20G11NC085JAONNNNN	
			104	114	156	55	85	128	156	45	20G11NC104JAONNNNN	
			140	154	210	75	104	156	210	55	20G1ANC140JNONNNNN ⁽⁵⁾	6
			170	187	255	90	140	210	255	75	20G1ANC170JNONNNNN ⁽⁵⁾	
			205	226	308	110	170	255	308	90	20G1ANC205JNONNNNN ⁽⁵⁾	
			260	286	390	132	205	308	390	110	20G1ANC260JNONNNNN ⁽⁵⁾	
			302	332	453	160	260	390	468	132	20G1ANC302JNONNNNN ⁽⁵⁾	
			367	404	551	200	302	453	551	160	20G1ANC367JNONNNNN ⁽⁵⁾	7
			456	502	684	250	367	551	684	200	20G1ANC456JNONNNNN ⁽⁵⁾	
			477	525	716	270	367	551	684	200	20G1ANC477JNONNNNN ⁽⁵⁾	

- (1) Frames 1...5 are IP20, NEMA/UL Type Open. Frames 6...7 are IP00, NEMA/UL Type Open. Frames 8...10 are IP20, NEMA/UL Type 1. Frames 1...7 can be converted to IP20, NEMA/UL Type 1 with optional kit (20-750-NEMA1-Fx), where x is the frame size of the drive.
- (2) Light Duty rating only available on Frame 8...10 drives. Light Duty allows 110% overload for 1 minute, and does not have a 3 second overload rating.
- (3) The 5th character determines Input Type; "1" = AC input with precharge and DC terminals, and "A" = AC input with precharge and no DC terminals. For DC input drives, see [DRIVES-SG001](#), the PowerFlex Common Bus Configuration Selection Guide.
- (4) The 11th character determines default Filtering and Common Mode Cap jumper configuration; "J" = Installed, and "A" = Removed.
- (5) The 12th character determines whether an internal dynamic braking IGBT is included; "A" = Internal dynamic braking transistor installed, and "N" = No internal dynamic braking transistor.

(table continues on next page)

380...400V AC, Three-phase Drives (continued)

IP00/IP20, NEMA/UL Type Open (continued)⁽¹⁾

Light Duty ⁽²⁾			Normal Duty				Heavy Duty				Cat. No. ⁽³⁾⁽⁴⁾	Frame Size
Output Amps		kW	Output Amps			kW	Output Amps			kW		
Cont.	1 min		Cont.	1 min	3 s		Cont.	1 min	3 s			
540	594	315	460	506	690	250	385	578	693	200	20G1A*C460JNONNNNN ⁽⁶⁾	8 ⁽⁷⁾
585	644	315	540	594	810	315	456	684	821	250	20G1A*C540JNONNNNN ⁽⁶⁾	
612	673	355	567	624	851	315	472	708	850	250	20G1A*C567JNONNNNN ⁽⁶⁾	
750	825	400	650	715	975	355	540	810	972	315	20G1A*C650JNONNNNN ⁽⁶⁾	
796	876	450	750	825	1125	400	585	878	1053	315	20G1A*C750JNONNNNN ⁽⁶⁾	
832	915	450	770	847	1155	400	642	963	1156	355	20G1A*C770JNONNNNN ⁽⁶⁾	
1040	1144	560	910	1001	1365	500	750	1125	1350	400	20G11*C910JNONNNNN ⁽⁶⁾	9 ⁽⁷⁾
1090	1199	630	1040	1144	1560	560	880	1320	1584	500	20G11*C1K0JNONNNNN ⁽⁶⁾	
1175	1293	710	1090	1199	1635	630	910	1365	1638	500	20G11*C1K1JNONNNNN ⁽⁶⁾	
1465	1612	800	1175	1293	1763	710	1040	1560	1872	560	20G11*C1K2JNONNNNN ⁽⁶⁾	
1480	1628	850	1465	1612	2198	800	1090	1635	1962	630	20G11*C1K4JNONNNNN ⁽⁶⁾	
1600	1760	900	1480	1628	2220	850	1175	1763	2115	710	20G11*C1K5JNONNNNN ⁽⁶⁾	
1715	1887	1000	1590	1749	2385	900	1325	1988	2385	710	20G11*C1K6JNONNNNN ⁽⁶⁾	10 ⁽⁷⁾
2330	2563	1400	2150	2365	3225	1250	1800	2700	3240	1000	20G11*C2K1JNONNNNN ⁽⁶⁾	

(1) Frames 1...5 are IP20, NEMA/UL Type Open. Frames 6...7 are IP00, NEMA/UL Type Open. Frames 8...10 are IP20, NEMA/UL Type 1. Frames 1...7 can be converted to IP20, NEMA/UL Type 1 with optional kit (20-750-NEMA1-Fx), where x is the frame size of the drive.

(2) Light Duty rating only available on Frame 8...10 drives. Light Duty allows 110% overload for 1 minute, and does not have a 3 second overload rating.

(3) The 5th character determines Input Type; "1" = AC input with precharge and DC terminals, and "A" = AC input with precharge and no DC terminals. For DC input drives, see [DRIVES-SG001](#), the PowerFlex Common Bus Configuration Selection Guide.

(4) The 11th character determines default Filtering and Common Mode Cap jumper configuration; "J" = Installed, and "A" = Removed.

(5) The 12th character determines whether an internal dynamic braking IGBT is included; "A" = Internal dynamic braking transistor installed, and "N" = No internal dynamic braking transistor.

(6) The 6th character (designated by an * in this table) determines Enclosure Type and Depth. "B" = IP20, NEMA/UL Type 1, MCC style 600 mm (23.6 in.) deep, and "L" = IP20, NEMA/UL Type 1, MCC style 800 mm (31.5 in.).

(7) A roll-out cart is required with Frame 8...10 drives to assist with power wiring and cabinet mounting. Refer to page 131.

380...400V AC, Three-phase Drives (continued)

IP54, NEMA/UL Type 12

Light Duty ⁽¹⁾			Normal Duty				Heavy Duty				Cat. No. ⁽²⁾⁽³⁾	Frame Size
Output Amps		kW	Output Amps			kW	Output Amps			kW		
Cont.	1 min		Cont.	1 min	3 s		Cont.	1 min	3 s			
—	—	—	2.1	3.1	3.7	0.75	2.1	3.1	3.7	0.75	20G11GC2P1JA0NNNNNN	2
			3.5	5.2	6.3	1.5	3.5	5.2	6.3	1.5	20G11GC3P5JA0NNNNNN	
			5	7.5	9	2.2	5	7.5	9.0	2.2	20G11GC5P0JA0NNNNNN	
			8.7	13	15.6	4	8.7	13	15.6	4	20G11GC8P7JA0NNNNNN	
			11.5	17.2	20.7	5.5	11.5	17.2	20.7	5.5	20G11GC011JA0NNNNNN	
			15.4	16.9	23.1	7.5	11.5	17.2	23.1	5.5	20G11GC015JA0NNNNNN	
			22	24.2	33	11	15.4	24.2	33	7.5	20G11GC022JA0NNNNNN	
			30	33	45	15	22	33	45	11	20G11GC030JA0NNNNNN	3
			37	40.7	55.5	18.5	30	45	55.5	15	20G11GC037JA0NNNNNN	
			43	47.3	64.5	22	37	55.5	66.6	18.5	20G11GC043JA0NNNNNN	
			60	66	90	30	43	66	90	22	20G11GC060JA0NNNNNN	4
			72	79.2	108	37	60	90	108	30	20G11GC072JA0NNNNNN	5
			85	93.5	128	45	72	108	130	37	20G11GC085JA0NNNNNN	6
			104	114	156	55	85	128	156	45	20G1AGC104JN0NNNNN ⁽⁴⁾	
			140	154	210	75	104	156	210	55	20G1AGC140JN0NNNNN ⁽⁴⁾	
			170	187	255	90	140	210	255	75	20G1AGC170JN0NNNNN ⁽⁴⁾	
			205	226	308	110	170	255	308	90	20G1AGC205JN0NNNNN ⁽⁴⁾	
			260	286	390	132	205	308	390	110	20G1AGC260JN0NNNNN ⁽⁴⁾	
			302	332	453	160	260	390	468	132	20G1AGC302JN0NNNNN ⁽⁴⁾	
			367	404	551	200	302	453	551	160	20G1AGC367JN0NNNNN ⁽⁴⁾	7
			456	502	684	250	367	551	684	200	20G1AGC456JN0NNNNN ⁽⁴⁾	
540	594	315	460	506	690	250	385	578	693	200	20G1AJC460JN0NNNNN	
585	644	315	540	594	810	315	456	684	821	250	20G1AJC540JN0NNNNN	
612	673	355	567	624	851	315	472	708	850	250	20G1AJC567JN0NNNNN	
750	825	400	650	715	975	355	540	810	972	315	20G1AJC650JN0NNNNN	
796	876	450	750	825	1125	400	585	878	1053	315	20G1AJC750JN0NNNNN	
832	915	450	770	847	1155	400	642	963	1156	355	20G1AJC770JN0NNNNN	
1040	1144	560	910	1001	1365	500	750	1125	1350	400	20G11JC910JN0NNNNN	9 ⁽⁵⁾
1090	1199	630	1040	1144	1560	560	880	1320	1584	500	20G11JC1K0JN0NNNNN	
1175	1293	710	1090	1199	1635	630	910	1365	1638	500	20G11JC1K1JN0NNNNN	
1465	1612	800	1175	1293	1763	710	1040	1560	1872	560	20G11JC1K2JN0NNNNN	
1480	1628	850	1465	1612	2198	800	1090	1635	1962	630	20G11JC1K4JN0NNNNN	
1600	1760	900	1480	1628	2220	850	1175	1763	2115	710	20G11JC1K5JN0NNNNN	
1715	1887	1000	1590	1749	2385	900	1325	1988	2385	710	20G11JC1K6JN0NNNNN	
2330	2563	1400	2150	2365	3225	1250	1800	2700	3240	1000	20G11JC2K1JN0NNNNN	

(1) These drives have dual current ratings; one for normal duty applications, and one for heavy duty applications (in parenthesis). The drive can be operated at either rating.

(2) The 11th character determines default Filtering and Common Mode Cap jumper configuration. "J" = Installed, "A" = Removed.

(3) Alternate 600V ratings when connected to drives 60 Hp and greater in common DC input applications with uncontrolled front ends.

(4) Also available with internal Brake IGBT (20G1xxxxxxAN0NNNNN).

(5) A roll-out cart is required with Frame 8...10 drives to assist with power wiring and cabinet mounting. Refer to page 131.

380...400V AC, Three-phase Drives (continued)

Flange Mount (Front: IP20, NEMA/UL Type Open; Back/Heatsink: IP66, NEMA/UL Type 4X)

Note: Frame 6...7 IP00, NEMA Type Open drives can be converted to a flange mount drive (Back/Heatsink: IP66, NEMA/UL Type 4X) with an optional user installed flange kit (20-750-FLNG4-F6 for Frame 6, and 20-750-FLNG4-F7 for Frame 7). See page 88 for 380...400V, Frame 6...7 IP00, NEMA Type Open drives.

Normal Duty				Heavy Duty				Cat. No. ⁽¹⁾⁽²⁾	Frame Size
Outputs Amp			kW	Output Amps			kW		
Cont.	1 min	3 s		Cont.	1 min	3 s			
2.1	3.1	3.7	0.75	2.1	3.1	3.7	0.75	20G11FC2P1JA0NNNNN	2
3.5	5.2	6.3	1.5	3.5	5.2	6.3	1.5	20G11FC3P5JA0NNNNN	
5	7.5	9	2.2	5	7.5	9	2.2	20G11FC5P0JA0NNNNN	
8.7	13	15.6	4	8.7	13	15.6	4	20G11FC8P7JA0NNNNN	
11.5	17.2	20.7	5.5	11.5	17.2	20.7	5.5	20G11FC011JA0NNNNN	
15.4	16.9	23.1	7.5	11.5	17.2	23.1	5.5	20G11FC015JA0NNNNN	
22	24.2	33	11	15.4	24.2	33	7.5	20G11FC022JA0NNNNN	
30	33	45	15	22	33	45	11	20G11FC030JA0NNNNN	3
37	40.7	55.5	18.5	30	45	55.5	15	20G11FC037JA0NNNNN	
43	47.3	64.5	22	37	55.5	66.6	18.5	20G11FC043JA0NNNNN	
60	66	90	30	43	66	90	22	20G11FC060JA0NNNNN	4
72.0	79.2	108	37	60	90	108	30	20G11FC072JA0NNNNN	
85	93.5	128	45	72	108	130	37	20G11FC085JA0NNNNN	5
104	114	156	55	85	128	156	45	20G11FC104JA0NNNNN	

(1) The 5th character determines Input Type; "1" = AC input with precharge and DC terminals, and "A" = AC input with precharge and no DC terminals. For DC input drives, see [DRIVES-SG001](#), the PowerFlex Common Bus Configuration Selection Guide.

(2) The 11th character determines default Filtering and Common Mode Cap jumper configuration; "J" = Installed, and "A" = Removed.

480V AC, Three-phase Drives

IP00/IP20, NEMA/UL Type Open⁽¹⁾

Light Duty ⁽²⁾			Normal Duty				Heavy Duty				Cat. No. ⁽³⁾⁽⁴⁾	Frame Size
Output Amps		Hp	Output Amps			Hp	Output Amps			Hp		
Cont.	1 min		Cont.	1 min	3 s		Cont.	1 min	3 s			
—	—	—	2.1	2.3	3.2	1	1.1	2.3	3.2	0.5	20G11RD2P1JA0NNNNN	1
			3.4	3.7	5.1	2	2.8	4.2	5.1	1	20G11RD3P4JA0NNNNN	
			5	5.5	7.5	3	3.4	5.5	7.5	2	20G11RD5P0JA0NNNNN	
			8	8.8	12	5	5	8.8	12	3	20G11RD8P0JA0NNNNN	
			11	12.1	16.5	7.5	8	12.1	16.5	5	20G11RD011JA0NNNNN	
			14	15.4	21	10	11	16.5	21	7.5	20G11RD014JA0NNNNN	
			2.1	3.1	3.7	1	2.1	3.1	3.7	1	20G11ND2P1JA0NNNNN	2
			3.4	5.1	6.1	2	3.4	5.1	6.1	2	20G11ND3P4JA0NNNNN	
			5	7.5	9.0	3	5	7.5	9	3	20G11ND5P0JA0NNNNN	
			8	12	14.4	5	8	12	14.4	5	20G11ND8P0JA0NNNNN	
			11	16.5	19.8	7.5	11	16.5	19.8	7.5	20G11ND011JA0NNNNN	
			14	15.4	21	10	11	16.5	21	7.5	20G11ND014JA0NNNNN	
			22	24.2	33	15	14	24.2	33	10	20G11ND022JA0NNNNN	3
			27	29.7	40.5	20	22	33	40.5	15	20G11ND027JA0NNNNN	
			34	37.4	51	25	27	40.5	51	20	20G11ND034JA0NNNNN	
			40	44	60	30	34	51	61.2	25	20G11ND040JA0NNNNN	
			52	57.2	78.0	40	40	60	78	30	20G11ND052JA0NNNNN	
			65	71.5	97.5	50	52	78	97.5	40	20G11ND065JA0NNNNN	
			77	84.7	116	60	65	97.5	116	50	20G11ND077JA0NNNNN	4
			96	106	144	75	77	116	144	60	20G11ND096JA0NNNNN	
			125	138	188	100	96	144	188	75	20G1AND125JNONNNNN ⁽⁵⁾	
			156	172	234	125	125	188	234	100	20G1AND156JNONNNNN ⁽⁵⁾	
			186	205	279	150	156	234	281	125	20G1AND186JNONNNNN ⁽⁵⁾	
			248	273	372	200	186	279	372	150	20G1AND248JNONNNNN ⁽⁵⁾	
			302	332	453	250	248	372	453	200	20G1AND302JNONNNNN ⁽⁵⁾	5
			361	397	542	300	302	453	535	250	20G1AND361JNONNNNN ⁽⁵⁾	
			415	457	623	350	361	542	650	300	20G1AND415JNONNNNN ⁽⁵⁾	
			477	525	716	400	361	542	650	300	20G1AND477JNONNNNN ⁽⁵⁾	

- (1) Frames 1...5 are IP20, NEMA/UL Type Open. Frames 6...7 are IP00, NEMA/UL Type Open. Frames 8...10 are IP20, NEMA/UL Type 1. Frames 1...7 can be converted to IP20, NEMA/UL Type 1 with optional kit (20-750-NEMA1-Fx), where x is the frame size of the drive.
- (2) Light Duty rating only available on Frame 8...10 drives. Light Duty allows 110% overload for 1 minute, and does not have a 3 second overload rating.
- (3) The 5th character determines Input Type; "1" = AC input with precharge and DC terminals, and "A" = AC input with precharge and no DC terminals. For DC input drives, see [DRIVES-SG001](#), the PowerFlex Common Bus Configuration Selection Guide.
- (4) The 11th character determines default Filtering and Common Mode Cap jumper configuration; "J" = Installed, and "A" = Removed.
- (5) The 12th character determines whether an internal dynamic braking IGBT is included; "A" = Internal dynamic braking transistor installed, and "N" = No internal dynamic braking transistor.
- (6) The 6th character (designated by an * in this table) determines Enclosure Type and Depth. "B" = IP20, NEMA/UL Type 1, MCC style 600 mm (23.6 in.) deep, and "L" = IP20, NEMA/UL Type 1, MCC style 800 mm (31.5 in.).
- (7) A roll-out cart is required with Frame 8...10 drives to assist with power wiring and cabinet mounting. Refer to page 131.

(table continues on next page)

480V AC, Three-phase Drives (continued)

IP00/IP20, NEMA/UL Type Open (continued)⁽¹⁾

Light Duty ⁽²⁾			Normal Duty				Heavy Duty				Cat. No. ⁽³⁾⁽⁴⁾	Frame Size
Output Amps		Hp	Output Amps			Hp	Output Amps			Hp		
Cont.	1 min		Cont.	1 min	3 s		Cont.	1 min	3 s			
485	534	400	430	473	645	350	370	555	666	300	20G1A*D430JNONNNNN ⁽⁶⁾	8 ⁽⁷⁾
545	600	450	485	534	728	400	414	621	745	350	20G1A*D485JNONNNNN ⁽⁶⁾	
590	649	500	545	600	818	450	454	681	817	350	20G1A*D545JNONNNNN ⁽⁶⁾	
710	781	600	617	679	926	500	485	728	873	400	20G1A*D617JNONNNNN ⁽⁶⁾	
765	842	650	710	781	1065	600	545	818	981	450	20G1A*D710JNONNNNN ⁽⁶⁾	
800	880	700	740	814	1110	650	617	926	1111	500	20G1A*D740JNONNNNN ⁽⁶⁾	
960	1056	800	800	880	1200	700	710	1065	1278	600	20G11*D800JNONNNNN ⁽⁶⁾	9 ⁽⁷⁾
1045	1150	900	960	1056	1440	800	795	1193	1431	700	20G11*D960JNONNNNN ⁽⁶⁾	
1135	1249	1000	1045	1150	1568	900	800	1200	1440	750	20G11*D1K0JNONNNNN ⁽⁶⁾	
1365	1502	1100	1135	1249	1703	1000	960	1440	1728	800	20G11*D1K2JNONNNNN ⁽⁶⁾	
1420	1562	1250	1365	1502	2048	1100	1045	1568	1881	900	20G11*D1K3JNONNNNN ⁽⁶⁾	
1540	1694	1350	1420	1562	2130	1250	1135	1703	2043	1000	20G11*D1K4JNONNNNN ⁽⁶⁾	
1655	1821	1500	1525	1678	2288	1350	1270	1905	2286	1100	20G11*D1K5JNONNNNN ⁽⁶⁾	10 ⁽⁷⁾
2240	2464	2000	2070	2277	3105	1750	1730	2595	3114	1650	20G11*D2K0JNONNNNN ⁽⁶⁾	

(1) Frames 1...5 are IP20, NEMA/UL Type Open. Frames 6...7 are IP00, NEMA/UL Type Open. Frames 8...10 are IP20, NEMA/UL Type 1. Frames 1...7 can be converted to IP20, NEMA/UL Type 1 with optional kit (20-750-NEMA1-Fx), where x is the frame size of the drive.

(2) Light Duty rating only available on Frame 8...10 drives. Light Duty allows 110% overload for 1 minute, and does not have a 3 second overload rating.

(3) The 5th character determines Input Type; "1" = AC input with precharge and DC terminals, and "A" = AC input with precharge and no DC terminals. For DC input drives, see [DRIVES-SG001](#), the PowerFlex Common Bus Configuration Selection Guide.

(4) The 11th character determines default Filtering and Common Mode Cap jumper configuration; "J" = Installed, and "A" = Removed.

(5) The 12th character determines whether an internal dynamic braking IGBT is included; "A" = Internal dynamic braking transistor installed, and "N" = No internal dynamic braking transistor.

(6) The 6th character (designated by an * in this table) determines Enclosure Type and Depth. "B" = IP20, NEMA/UL Type 1, MCC style 600 mm (23.6 in.) deep, and "L" = IP20, NEMA/UL Type 1, MCC style 800 mm (31.5 in.).

(7) A roll-out cart is required with Frame 8...10 drives to assist with power wiring and cabinet mounting. Refer to page 131.

480V AC, Three-phase Drives (continued)

IP54, NEMA/UL Type 12

Light Duty ⁽¹⁾			Normal Duty				Heavy Duty				Cat. No. ⁽²⁾⁽³⁾	Frame Size
Output Amps		Hp	Output Amps			Hp	Output Amps			Hp		
Cont.	1 min		Cont.	1 min	3 s		Cont.	1 min	3 s			
—	—	—	2.1	3.1	3.7	1	2.1	3.1	3.7	1	20G11GD2P1JAONNNNN	2
			3.4	5.1	6.1	2	3.4	5.1	6.1	2	20G11GD3P4JAONNNNN	
			5	7.5	9	3	5	7.5	9	3	20G11GD5P0JAONNNNN	
			8	12	14.4	5	8	12	14.4	5	20G11GD8P0JAONNNNN	
			11	16.5	19.8	7.5	11	16.5	19.8	7.5	20G11GD011JAONNNNN	
			14	15.4	21	10	11	16.5	21	7.5	20G11GD014JAONNNNN	
			22	24.2	33	15	14	24.2	33	10	20G11GD022JAONNNNN	
			27	29.7	40.5	20	22	33	40.5	15	20G11GD027JAONNNNN	3
			34	37.4	51	25	27	40.5	51	20	20G11GD034JAONNNNN	
			40	44	60	30	34	51	61.2	25	20G11GD040JAONNNNN	
			52	57.2	78	40	40	60	78	30	20G11GD052JAONNNNN	4
			65	71.5	97.5	50	52	78	97.5	40	20G11GD065JAONNNNN	5
			77	84.7	116	60	65	97.5	116	50	20G11GD077JAONNNNN	6
			96	106	144	75	77	116	144	60	20G1AGD096JNONNNNN ⁽⁴⁾	
			125	138	188	100	96	144	188	75	20G1AGD125JNONNNNN ⁽⁴⁾	
			156	172	234	125	125	188	234	100	20G1AGD156JNONNNNN ⁽⁴⁾	
			186	205	279	150	156	234	281	125	20G1AGD186JNONNNNN ⁽⁴⁾	
			248	273	372	200	186	279	372	150	20G1AGD248JNONNNNN ⁽⁴⁾	
			302	332	453	250	248	372	453	200	20G1AGD302JNONNNNN ⁽⁴⁾	
			361	397	542	300	302	453	535	250	20G1AGD361JNONNNNN ⁽⁴⁾	7
			415	457	623	350	361	542	650	300	20G1AGD415JNONNNNN ⁽⁴⁾	
485	534	400	430	473	645	350	370	555	666	300	20G1AJD430JNONNNNN	
545	600	450	485	534	728	400	414	621	745	350	20G1AJD485JNONNNNN	8 ⁽⁵⁾
590	649	500	545	600	818	450	454	681	817	350	20G1AJD545JNONNNNN	
710	781	600	617	679	926	500	485	728	873	400	20G1AJD617JNONNNNN	
765	842	650	710	781	1065	600	545	818	981	450	20G1AJD710JNONNNNN	
800	880	700	740	814	1110	650	617	926	1111	500	20G1AJD740JNONNNNN	
960	1056	800	800	880	1200	700	710	1065	1278	600	20G11JD800JNONNNNN	
1045	1150	900	960	1056	1440	800	795	1193	1431	700	20G11JD960JNONNNNN	
1135	1249	1000	1045	1150	1568	900	800	1200	1440	750	20G11JD1K0JNONNNNN	
1365	1502	1100	1135	1249	1703	1000	960	1440	1728	800	20G11JD1K2JNONNNNN	
1420	1562	1250	1365	1502	2048	1100	1045	1568	1881	900	20G11JD1K3JNONNNNN	
1540	1694	1350	1420	1562	2130	1250	1135	1703	2043	1000	20G11JD1K4JNONNNNN	
1655	1821	1500	1525	1678	2288	1350	1270	1905	2286	1100	20G11JD1K5JNONNNNN	
2240	2464	2000	2070	2277	3105	1750	1730	2595	3114	1650	20G11JD2K0JNONNNNN	10 ⁽⁵⁾

(1) Light Duty rating only available on Frame 8...10 drives. Light Duty allows 110% overload for 1 minute, and does not have a 3 second overload rating.

(2) The 5th character determines Input Type; "1" = AC input with precharge and DC terminals, and "A" = AC input with precharge and no DC terminals. For DC input drives, see [DRIVES-SG001](#), the PowerFlex Common Bus Configuration Selection Guide.

(3) The 11th character determines default Filtering and Common Mode Cap jumper configuration; "J" = Installed, and "A" = Removed.

(4) The 12th character determines whether an internal dynamic braking IGBT is included; "A" = Internal dynamic braking transistor installed, and "N" = No internal dynamic braking transistor.

(5) A roll-out cart is required with Frame 8...10 drives to assist with power wiring and cabinet mounting. Refer to page 131.

480V AC, Three-phase Drives (continued)

Flange Mount (Front: IP20, NEMA/UL Type Open; Back/Heatsink: IP66, NEMA/UL Type 4X)

Note: Frame 6...7 IP00, NEMA Type Open drives can be converted to a flange mount drive (Back/Heatsink: IP66, NEMA/UL Type 4X) with an optional user installed flange kit (20-750-FLNG4-F6 for Frame 6, and 20-750-FLNG4-F7 for Frame 7). See page 91 for 480V, Frame 6...7 IP00, NEMA Type Open drives.

Normal Duty				Heavy Duty				Cat. No. ⁽¹⁾⁽²⁾	Frame Size
Output Amps			Hp	Output Amps			Hp		
Cont.	1 min	3 s		Cont.	1 min	3 s			
2.1	3.1	3.7	1	2.1	3.1	3.7	1	20G11FD2P1JA0NNNNN	2
3.4	5.1	6.1	2	3.4	5.1	6.1	2	20G11FD3P4JA0NNNNN	
5	7.5	9	3	5	7.5	9	3	20G11FD5P0JA0NNNNN	
8	12	14.4	5	8	12	14.4	5	20G11FD8P0JA0NNNNN	
11	16.5	19.8	7.5	11	16.5	19.8	7.5	20G11FD011JA0NNNNN	
14	15.4	21	10	11	16.5	21	7.5	20G11FD014JA0NNNNN	
22	24.2	33	15	14	24.2	33	10	20G11FD022JA0NNNNN	
27	29.7	40.5	20	22	33	40.5	15	20G11FD027JA0NNNNN	3
34	37.4	51	25	27	40.5	51	20	20G11FD034JA0NNNNN	
40	44	60	30	34	51	61.2	25	20G11FD040JA0NNNNN	
52.0	57.2	78	40	40	60	78	30	20G11FD052JA0NNNNN	4
65.0	71.5	97.5	50	52	78	97.5	40	20G11FD065JA0NNNNN	
77	84.7	116	60	65	97.5	116	50	20G11FD077JA0NNNNN	5
96	106	144	75	77	116	144	60	20G11FD096JA0NNNNN	

(1) The 5th character determines Input Type; "1" = AC input with precharge and DC terminals, and "A" = AC input with precharge and no DC terminals. For DC input drives, see [DRIVES-SG001](#), the PowerFlex Common Bus Configuration Selection Guide.

(2) The 11th character determines default Filtering and Common Mode Cap jumper configuration. "J" = Installed, "A" = Removed.

600V AC, Three-phase Drives

Frames 3, 4, and 5 are only 600V AC drives. Frames 6 and 7 are dual-voltage drives, and can be operated at 600 V or 690V AC.

Important: Frames 3, 4, and 5 must not be used in common DC input-sharing applications with Frames 6 or larger drives. For more details, contact your local Rockwell Automation sales office or your Allen-Bradley distributor.

IP00/IP20, NEMA/UL Type Open⁽¹⁾

Light Duty ⁽²⁾			Normal Duty				Heavy Duty				Cat. No. ⁽³⁾⁽⁴⁾	Frame Size
Outputs Amp		Hp	Outputs Amp			Hp	Output Amps			Hp		
Cont.	1 min		Cont.	1 min	3 s		Cont.	1 min	3 s			
—	—	—	1.7	1.9	2.6	1	1.7	1.4	2.6	1	20G11NE1P7JAONNNNN	3
			2.7	3	4.1	2	1.7	2.6	4.1	1	20G11NE2P7JAONNNNN	
			3.9	4.29	5.85	3	2.7	4.1	5.9	2	20G11NE3P9JAONNNNN	
			6.1	6.7	9.2	5	3.9	5.9	9.2	3	20G11NE6P1JAONNNNN	
			9	9.9	13.5	7.5	6.1	9.2	13.5	5	20G11NE9P0JAONNNNN	
			11	12.1	16.5	10	9	13.5	16.5	7.5	20G11NE011JAONNNNN	
			17	18.7	25.5	15	11	16.5	25.5	10	20G11NE017JAONNNNN	
			22	24.2	33	20	17	25.5	33	15	20G11NE022JAONNNNN	
			27	29.7	40.5	25	22	33	40.5	20	20G11NE027JAONNNNN	4
			32	35.2	48	30	27	40.5	48.6	25	20G11NE032JAONNNNN	
			41	45.1	61.5	40	32	48	61.5	30	20G11NE041JAONNNNN	
			52	57.2	78	50	41	61.5	78	40	20G11NE052JAONNNNN	5
			12	13.2	18	10	9.1	13.7	18	7.5	20G1ANE012JNONNNNN ⁽⁵⁾	
			18	19.8	27	15	12	18	27	10	20G1ANE018JNONNNNN ⁽⁵⁾	
			23	25.3	34.5	20	18	27	34.5	15	20G1ANE023JNONNNNN ⁽⁵⁾	
			24	26.4	36	20	22	33	39.6	20	20G1ANE024JNONNNNN ⁽⁵⁾	
			28	30.8	42	25	23	34.5	42	20	20G1ANE028JNONNNNN ⁽⁵⁾	
			33	36.3	49.5	30	28	42	50.4	25	20G1ANE033JNONNNNN ⁽⁵⁾	
			42	46.2	63	40	33	49.5	63	30	20G1ANE042JNONNNNN ⁽⁵⁾	
			53	58	80	50	42	63	80	40	20G1ANE053JNONNNNN ⁽⁵⁾	
			63	69	95	60	52	78	95	50	20G1ANE063JNONNNNN ⁽⁵⁾	
			77	85	116	75	63	95	116	60	20G1ANE077JNONNNNN ⁽⁵⁾	
			99	109	149	100	77	116	149	75	20G1ANE099JNONNNNN ⁽⁵⁾	
			125	138	188	125	99	149	188	100	20G1ANE125JNONNNNN ⁽⁵⁾	
			144	158	216	150	125	188	225	125	20G1ANE144JNONNNNN ⁽⁵⁾	
			192	211	288	200	144	216	288	150	20G1ANE192JNONNNNN ⁽⁵⁾	7
			242	266	363	250	192	288	363	200	20G1ANE242JNONNNNN ⁽⁵⁾	
			289	318	434	300	242	363	436	250	20G1ANE289JNONNNNN ⁽⁵⁾	

(1) Frames 3...5 are IP20, NEMA/UL Type Open. Frames 6...7 are IP00, NEMA/UL Type Open. Frames 8...10 are IP20, NEMA/UL Type 1. Frames 3...7 can be converted to IP20, NEMA/UL Type 1 with optional kit (20-750-NEMA1-Fx), where x is the frame size of the drive.

(2) Light Duty rating only available on Frame 8...10 drives. Light Duty allows 110% overload for 1 minute, and does not have a 3 second overload rating.

(3) The 5th character determines Input Type; "1" = AC input with precharge and DC terminals, and "A" = AC input with precharge and no DC terminals. For DC input drives, see [DRIVES-SG001](#), the PowerFlex Common Bus Configuration Selection Guide.

(4) The 11th character determines default Filtering and Common Mode Cap jumper configuration; "J" = Installed, and "A" = Removed.

(5) The 12th character determines whether an internal dynamic braking IGBT is included; "A" = Internal dynamic braking transistor installed, and "N" = No internal dynamic braking transistor.

(6) The 6th character (designated by an * in this table) determines Enclosure Type and Depth. "B" = IP20, NEMA/UL Type 1, MCC style 600 mm (23.6 in.) deep, and "L" = IP20, NEMA/UL Type 1, MCC style 800 mm (31.5 in.).

(7) A roll-out cart is required with Frame 8...10 drives to assist with power wiring and cabinet mounting. Refer to page 131.

(table continues on next page)

600V AC, Three-phase Drives (continued)

Frames 3, 4, and 5 are only 600V AC drives. Frames 6 and 7 are dual-voltage drives, and can be operated at 600 V or 690V AC.

Important: Frames 3, 4, and 5 must not be used in common DC input-sharing applications with Frames 6 or larger drives. For more details, contact your local Rockwell Automation sales office or your Allen-Bradley distributor.

IP00/IP20, NEMA/UL Type Open (continued)⁽¹⁾

Light Duty ⁽²⁾			Normal Duty				Heavy Duty				Cat. No. ⁽³⁾⁽⁴⁾	Frame Size
Outputs Amp		Hp	Outputs Amp			Hp	Output Amps			Hp		
Cont.	1 min		Cont.	1 min	3 s		Cont.	1 min	3 s			
355	391	350	295	325	443	300	272	408	490	250	20G1A*E295JNONNNNN ⁽⁶⁾	8 ⁽⁷⁾
395	435	400	355	391	533	350	295	443	531	300	20G1A*E355JNONNNNN ⁽⁶⁾	
435	479	450	395	435	593	400	329	494	592	350	20G1A*E395JNONNNNN ⁽⁶⁾	
460	506	500	435	479	653	450	355	533	639	350	20G1A*E435JNONNNNN ⁽⁶⁾	
510	561	500	460	506	690	500	395	593	711	400	20G1A*E460JNONNNNN ⁽⁶⁾	
545	600	550	510	561	765	500	425	638	765	450	20G1A*E510JNONNNNN ⁽⁶⁾	9 ⁽⁷⁾
690	759	700	595	655	893	600	510	765	918	500	20G11*E595JNONNNNN ⁽⁶⁾	
760	836	800	630	693	945	700	595	893	1071	600	20G11*E630JNONNNNN ⁽⁶⁾	
835	919	900	760	836	1140	800	630	945	1134	700	20G11*E760JNONNNNN ⁽⁶⁾	
900	990	950	825	908	1238	900	700	1050	1260	750	20G11*E825JNONNNNN ⁽⁶⁾	
980	1078	1000	900	990	1350	950	760	1140	1368	800	20G11*E900JNONNNNN ⁽⁶⁾	10 ⁽⁷⁾
1045	1150	1100	980	1078	1470	1000	815	1223	1467	900	20G11*E980JNONNNNN ⁽⁶⁾	
1220	1342	1200	1110	1221	1665	1100	920	1380	1656	1000	20G11*E1K1JNONNNNN ⁽⁶⁾	
1530	1683	1500	1430	1573	2145	1400	1190	1785	2142	1250	20G11*E1K4JNONNNNN ⁽⁶⁾	

(1) Frames 3...5 are IP20, NEMA/UL Type Open. Frames 6...7 are IP00, NEMA/UL Type Open. Frames 8...10 are IP20, NEMA/UL Type 1. Frames 3...7 can be converted to IP20, NEMA/UL Type 1 with optional kit (20-750-NEMA1-Fx), where x is the frame size of the drive.

(2) Light Duty rating only available on Frame 8...10 drives. Light Duty allows 110% overload for 1 minute, and does not have a 3 second overload rating.

(3) The 5th character determines Input Type; "1" = AC input with precharge and DC terminals, and "A" = AC input with precharge and no DC terminals. For DC input drives, see [DRIVES-SG001](#), the PowerFlex Common Bus Configuration Selection Guide.

(4) The 11th character determines default Filtering and Common Mode Cap jumper configuration; "J" = Installed, and "A" = Removed.

(5) The 12th character determines whether an internal dynamic braking IGBT is included; "A" = Internal dynamic braking transistor installed, and "N" = No internal dynamic braking transistor.

(6) The 6th character (designated by an * in this table) determines Enclosure Type and Depth. "B" = IP20, NEMA/UL Type 1, MCC style 600 mm (23.6 in.) deep, and "L" = IP20, NEMA/UL Type 1, MCC style 800 mm (31.5 in.).

(7) A roll-out cart is required with Frame 8...10 drives to assist with power wiring and cabinet mounting. Refer to page 131.

600V AC, Three-phase Drives (continued)

Frames 3, 4, and 5 are only 600V AC drives. Frames 6 and 7 are dual-voltage drives, and can be operated at 600 V or 690V AC.

Important: Frames 3, 4, and 5 must not be used in common DC input-sharing applications with Frames 6 or larger drives. For more details, contact your local Rockwell Automation sales office or your Allen-Bradley distributor.

IP54, NEMA/UL Type 12

Light Duty ⁽¹⁾		Hp	Normal Duty				Heavy Duty				Cat. No. ⁽²⁾⁽³⁾	Frame Size
Output Amps			Output Amps			Hp	Output Amps			Hp		
Cont.	1 min		Cont.	1 min	3 s		Cont.	1 min	3 s			
—	—	—	1.7	1.9	2.6	1	1.7	1.4	2.6	1	20G11GE1P7JAONNNNN	3
			2.7	3	4.1	2	1.7	2.6	4.1	1	20G11GE2P7JAONNNNN	
			3.9	4.29	5.85	3	2.7	4.1	5.9	2	20G11GE3P9JAONNNNN	
			6.1	6.7	9.2	5	3.9	5.9	9.2	3	20G11GE6P1JAONNNNN	
			9	9.9	13.5	7.5	6.1	9.2	13.5	5	20G11GE9P0JAONNNNN	
			11	12.1	16.5	10	9	13.5	16.5	7.5	20G11GE011JAONNNNN	
			17	18.7	25.5	15	11	16.5	25.5	10	20G11GE017JAONNNNN	
			22	24.2	33	20	17	25.5	33	15	20G11GE022JAONNNNN	
			27	29.7	40.5	25	22	33	40.5	20	20G11GE027JAONNNNN	4
			32	35.2	48	30	27	40.5	48.6	25	20G11GE032JAONNNNN	
			41	45.1	61.5	40	32.0	48	61.5	30	20G11GE041JAONNNNN	5
			12	13.2	18	10	9.1	13.7	18	7.5	20G1AGE012JNONNNNN ⁽⁴⁾	6
			18	19.8	27	15	12	18	27	10	20G1AGE018JNONNNNN ⁽⁴⁾	
			23	25.3	34.5	20	18	27	34.5	15	20G1AGE023JNONNNNN ⁽⁴⁾	
			24	26.4	36	20	22	33	39.6	20	20G1AGE024JNONNNNN ⁽⁴⁾	
			28	30.8	42	25	23	34.5	42	20	20G1AGE028JNONNNNN ⁽⁴⁾	
			33	36.3	49.5	30	28	42	50.4	25	20G1AGE033JNONNNNN ⁽⁴⁾	
			42	46.2	63	40	33	49.5	63	30	20G1AGE042JNONNNNN ⁽⁴⁾	
			53	58	80	50	42	63	80	40	20G1AGE053JNONNNNN ⁽⁴⁾	
			63	69	95	60	52	78	95	50	20G1AGE063JNONNNNN ⁽⁴⁾	
			77	85	116	75	63	95	116	60	20G1AGE077JNONNNNN ⁽⁴⁾	
			99	109	149	100	77	116	149	75	20G1AGE099JNONNNNN ⁽⁴⁾	
			125	138	188	125	99	149	188	100	20G1AGE125JNONNNNN ⁽⁴⁾	
			144	158	216	150	125	188	225	125	20G1AGE144JNONNNNN ⁽⁴⁾	
			192	211	288	200	144	216	288	150	20G1AGE192JNONNNNN ⁽⁴⁾	7
			242	266	363	250	192	288	363	200	20G1AGE242JNONNNNN ⁽⁴⁾	
			289	318	434	300	242	363	436	250	20G1AGE289JNONNNNN ⁽⁴⁾	

(1) Light Duty rating only available on Frame 8...10 drives. Light Duty allows 110% overload for 1 minute, and does not have a 3 second overload rating.

(2) The 5th character determines Input Type; "1" = AC input with precharge and DC terminals, and "A" = AC input with precharge and no DC terminals. For DC input drives, see [DRIVES-SG001](#), the PowerFlex Common Bus Configuration Selection Guide.

(3) The 11th character determines default Filtering and Common Mode Cap jumper configuration; "J" = Installed, and "A" = Removed.

(4) The 12th character determines whether an internal dynamic braking IGBT is included; "A" = Internal dynamic braking transistor installed, and "N" = No internal dynamic braking transistor.

(table continues on next page)

600V AC, Three-phase Drives (continued)

Frames 3, 4, and 5 are only 600V AC drives. Frames 6 and 7 are dual-voltage drives, and can be operated at 600 V or 690V AC.

Important: Frames 3, 4, and 5 must not be used in common DC input-sharing applications with Frames 6 or larger drives. For more details, contact your local Rockwell Automation sales office or your Allen-Bradley distributor.

IP54, NEMA/UL Type 12 (continued)

Light Duty ⁽¹⁾			Normal Duty				Heavy Duty				Cat. No. ⁽²⁾⁽³⁾	Frame Size
Output Amps		Hp	Output Amps			Hp	Output Amps			Hp		
Cont.	1 min		Cont.	1 min	3 s		Cont.	1 min	3 s			
355	391	350	295	325	443	300	272	408	490	250	20G1AJE295JNONNNNN	8 ⁽⁵⁾
395	435	400	355	391	533	350	295	443	531	300	20G1AJE355JNONNNNN	
435	479	450	395	435	593	400	329	494	592	350	20G1AJE395JNONNNNN	
460	506	500	435	479	653	450	355	533	639	350	20G1AJE435JNONNNNN	
510	561	500	460	506	690	500	395	593	711	400	20G1AJE460JNONNNNN	
545	600	550	510	561	765	500	425	638	765	450	20G1AJE510JNONNNNN	9 ⁽⁵⁾
690	759	700	595	655	893	600	510	765	918	500	20G11JE595JNONNNNN	
760	836	800	630	693	945	700	595	893	1071	600	20G11JE630JNONNNNN	
835	919	900	760	836	1140	800	630	945	1134	700	20G11JE760JNONNNNN	
900	990	950	825	908	1238	900	700	1050	1260	750	20G11JE825JNONNNNN	
980	1078	1000	900	990	1350	950	760	1140	1368	800	20G11JE900JNONNNNN	10 ⁽⁵⁾
1045	1150	1100	980	1078	1470	1000	815	1223	1467	900	20G11JE980JNONNNNN	
1220	1342	1200	1110	1221	1665	1100	920	1380	1656	1000	20G11JE1K1JNONNNNN	
1530	1683	1500	1430	1573	2145	1400	1190	1785	2142	1250	20G11JE1K4JNONNNNN	

(1) Light Duty rating only available on Frame 8...10 drives. Light Duty allows 110% overload for 1 minute, and does not have a 3 second overload rating.

(2) The 5th character determines Input Type; "1" = AC input with precharge and DC terminals, and "A" = AC input with precharge and no DC terminals. For DC input drives, see [DRIVES-SG001](#), the PowerFlex Common Bus Configuration Selection Guide.

(3) The 11th character determines default Filtering and Common Mode Cap jumper configuration; "J" = Installed, and "A" = Removed.

(4) The 12th character determines whether an internal dynamic braking IGBT is included; "A" = Internal dynamic braking transistor installed, and "N" = No internal dynamic braking transistor.

(5) A roll-out cart is required with Frame 8...10 drives to assist with power wiring and cabinet mounting. Refer to page 131.

600V AC, Three-phase Drives (continued)

Flange Mount (Front: IP20, NEMA/UL Type Open; Back/Heatsink: IP66, NEMA/UL Type 4X)

Frames 3, 4, and 5 are only 600V AC drives. Frames 6 and 7 are dual-voltage drives, and can be operated at 600 V or 690V AC.

Important: Frames 3, 4, and 5 must not be used in common DC input-sharing applications with Frames 6 or larger drives. For more details, contact your local Rockwell Automation sales office or your Allen-Bradley distributor.

Note: Frame 6...7 IP00, NEMA Type Open drives can be converted to a flange mount drive (back/heatsink: IP66, NEMA/UL Type 4X) with an optional user installed flange kit (kit 20-750-FLNG4-F6 for Frame 6, and kit 20-750-FLNG4-F7 for Frame 7). See page 95 for 600V, Frame 6...7 IP00, NEMA Type Open drives.

Normal Duty				Heavy Duty				Cat. No. ⁽¹⁾⁽²⁾	Frame Size
Outputs Amp			Hp	Output Amps			Hp		
Cont.	1 min	3 s		Cont.	1 min	3 s			
1.7	1.9	2.6	1	1.7	1.4	2.6	1	20G11FE1P7JA0NNNNN	3
2.7	3	4.1	2	1.7	2.6	4.1	1	20G11FE2P7JA0NNNNN	
3.9	4.29	5.85	3	2.7	4.1	5.9	2	20G11FE3P9JA0NNNNN	
6.1	6.7	9.2	5	3.9	5.9	9.2	3	20G11FE6P1JA0NNNNN	
9	9.9	13.5	7.5	6.1	9.2	13.5	5	20G11FE9P0JA0NNNNN	
11	12.1	16.5	10	9	13.5	16.5	7.5	20G11FE011JA0NNNNN	
17	18.7	25.5	15	11	16.5	25.5	10	20G11FE017JA0NNNNN	
22	24.2	33	20	17	25.5	33	15	20G11FE022JA0NNNNN	
27	29.7	40.5	25	22	33	40.5	20	20G11FE027JA0NNNNN	4
32	35.2	48	30	27	40.5	48.6	25	20G11FE032JA0NNNNN	
41	45.1	61.5	40	32	48	61.5	30	20G11FE041JA0NNNNN	5
52	57.2	78	50	41	61.5	78.0	40	20G11FE052JA0NNNNN	

(1) The 5th character determines Input Type; "1" = AC input with precharge and DC terminals, and "A" = AC input with precharge and no DC terminals. For DC input drives, see [DRIVES-SG001](#), the PowerFlex Common Bus Configuration Selection Guide.

(2) The 11th character determines default Filtering and Common Mode Cap jumper configuration. "J" = Installed, "A" = Removed.

690V AC, Three-phase Drives

IP00/IP20, NEMA/UL Type Open⁽¹⁾

Light Duty ⁽²⁾			Normal Duty				Heavy Duty				Cat. No. ⁽³⁾⁽⁴⁾	Frame Size
Output Amps		kW	Output Amps			kW	Output Amps			kW		
Cont.	1 min		Cont.	1 min	3 s		Cont.	1 min	3 s			
—	—	—	12	13.2	18	7.5	9	13.5	18	5.5	20G1ANF012JNONNNNN ⁽⁵⁾	6
			15	16.5	22.5	11	12	18	22.5	7.5	20G1ANF015JNONNNNN ⁽⁵⁾	
			20	22	30	15	15	22.5	30	11	20G1ANF020JNONNNNN ⁽⁵⁾	
			23	25.3	34.5	18.5	20	30	36	15	20G1ANF023JNONNNNN ⁽⁵⁾	
			30	33	45	22	23	34.5	45	18.5	20G1ANF030JNONNNNN ⁽⁵⁾	
			34	37.4	51	30	30	45	54	22	20G1ANF034JNONNNNN ⁽⁵⁾	
			46	50.6	69	37	34	51	69	30	20G1ANF046JNONNNNN ⁽⁵⁾	
			50	55	75	45	46	69	83	37	20G1ANF050JNONNNNN ⁽⁵⁾	
			61	67	92	55	50	75	92	45	20G1ANF061JNONNNNN ⁽⁵⁾	
			82	90	123	75	61	92	123	55	20G1ANF082JNONNNNN ⁽⁵⁾	
			98	108	147	90	82	123	148	75	20G1ANF098JNONNNNN ⁽⁵⁾	
			119	131	179	110	98	147	179	90	20G1ANF119JNONNNNN ⁽⁵⁾	
			142	156	213	132	119	179	214	110	20G1ANF142JNONNNNN ⁽⁵⁾	
			171	188	257	160	142	213	257	132	20G1ANF171JNONNNNN ⁽⁵⁾	7
			212	233	318	200	171	257	318	160	20G1ANF212JNONNNNN ⁽⁵⁾	
			263	289	395	250	212	318	395	200	20G1ANF263JNONNNNN ⁽⁵⁾	8 ⁽⁷⁾
330	363	315	265	292	398	250	215	323	387	200	20G1A*F265JNONNNNN ⁽⁶⁾	
370	407	355	330	363	495	315	265	398	477	250	20G1A*F330JNONNNNN ⁽⁶⁾	
410	451	400	370	407	555	355	308	462	554	300	20G1A*F370JNONNNNN ⁽⁶⁾	
460	506	450	415	457	623	400	370	555	666	355	20G1A*F415JNONNNNN ⁽⁶⁾	
500	550	500	460	506	690	450	375	563	675	375	20G1A*F460JNONNNNN ⁽⁶⁾	
530	583	530	500	550	750	500	413	620	743	400	20G1A*F500JNONNNNN ⁽⁶⁾	
650	715	630	590	649	885	560	460	690	828	450	20G11*F590JNONNNNN ⁽⁶⁾	
710	781	710	650	715	975	630	500	750	900	500	20G11*F650JNONNNNN ⁽⁶⁾	
790	869	800	710	781	1065	710	590	885	1062	560	20G11*F710JNONNNNN ⁽⁶⁾	
860	946	850	765	842	1148	750	650	975	1170	630	20G11*F765JNONNNNN ⁽⁶⁾	
960	1056	900	795	875	1193	800	750	1125	1350	710	20G11*F795JNONNNNN ⁽⁶⁾	10 ⁽⁷⁾
1020	1122	1000	960	1056	1440	900	795	1193	1431	800	20G11*F960JNONNNNN ⁽⁶⁾	
1150	1265	1100	1040	1144	1560	1000	865	1298	1557	900	20G11*F1K0JNONNNNN ⁽⁶⁾	
1485	1634	1500	1400	1540	2100	1400	1160	1740	2088	1120	20G11*F1K4JNONNNNN ⁽⁶⁾	

(1) Frames 6...7 are IP00, NEMA/UL Type Open. Frames 8...10 are IP20, NEMA/UL Type 1. Frames 6...7 can be converted to IP20, NEMA/UL Type 1 with optional kit (20-750-NEMA1-Fx), where x is the frame size of the drive.

(2) Light Duty rating only available on Frame 8...10 drives. Light Duty allows 110% overload for 1 minute, and does not have a 3 second overload rating.

(3) The 5th character determines Input Type; "1" = AC input with precharge and DC terminals, and "A" = AC input with precharge and no DC terminals. For DC input drives, see [DRIVES-SG001](#), the PowerFlex Common Bus Configuration Selection Guide.

(4) The 11th character determines default Filtering and Common Mode Cap jumper configuration; "J" = Installed, and "A" = Removed.

(5) The 12th character determines whether an internal dynamic braking IGBT is included; "A" = Internal dynamic braking transistor installed, and "N" = No internal dynamic braking transistor.

(6) The 6th character (designated by an * in this table) determines Enclosure Type and Depth. "B" = IP20, NEMA/UL Type 1, MCC style 600 mm (23.6 in.) deep, and "L" = IP20, NEMA/UL Type 1, MCC style 800 mm (31.5 in.).

(7) A roll-out cart is required with Frame 8...10 drives to assist with power wiring and cabinet mounting. Refer to page 131.

690V AC, Three-phase Drives (continued)

IP54, NEMA/UL Type 12

Light Duty ⁽¹⁾			Normal Duty				Heavy Duty				Cat. No. ⁽²⁾⁽³⁾	Frame Size
Output Amps		kW	Output Amps			kW	Output Amps			kW		
Cont.	1 min		Cont.	1 min	3 s		Cont.	1 min	3 s			
—	—	—	12	13.2	18	7.5	9	13.5	18	5.5	20G1AGF012JNONNNNN ⁽⁴⁾	6
			15	16.5	22.5	11	12	18	22.5	7.5	20G1AGF015JNONNNNN ⁽⁴⁾	
			20	22	30	15	15	22.5	30	11	20G1AGF020JNONNNNN ⁽⁴⁾	
			23	25.3	34.5	18.5	20	30	36	15	20G1AGF023JNONNNNN ⁽⁴⁾	
			30	33	45	22	23	34.5	45	18.5	20G1AGF030JNONNNNN ⁽⁴⁾	
			34	37.4	51	30	30	45	54	22	20G1AGF034JNONNNNN ⁽⁴⁾	
			46	50.6	69	37	34	51	69	30	20G1AGF046JNONNNNN ⁽⁴⁾	
			50	55	75	45	46	69	83	37	20G1AGF050JNONNNNN ⁽⁴⁾	
			61	67	92	55	50	75	92	45	20G1AGF061JNONNNNN ⁽⁴⁾	
			82	90	123	75	61	92	123	55	20G1AGF082JNONNNNN ⁽⁴⁾	
			98	108	147	90	82	123	148	75	20G1AGF098JNONNNNN ⁽⁴⁾	
			119	131	179	110	98	147	179	90	20G1AGF119JNONNNNN ⁽⁴⁾	
			142	156	213	132	119	179	214	110	20G1AGF142JNONNNNN ⁽⁴⁾	
			171	188	257	160	142	213	257	132	20G1AGF171JNONNNNN ⁽⁴⁾	
			212	233	318	200	171	257	318	160	20G1AGF212JNONNNNN ⁽⁴⁾	
			263	289	395	250	212	318	395	200	20G1AGF263JNONNNNN ⁽⁴⁾	
330	363	315	265	292	398	250	215	323	387	200	20G1AJF265JNONNNNN	8 ⁽⁵⁾
370	407	355	330	363	495	315	265	398	477	250	20G1AJF330JNONNNNN	
410	451	400	370	407	555	355	308	462	554	300	20G1AJF370JNONNNNN	
460	506	450	415	457	623	400	370	555	666	355	20G1AJF415JNONNNNN	
500	550	500	460	506	690	450	375	563	675	375	20G1AJF460JNONNNNN	
530	583	530	500	550	750	500	413	620	743	400	20G1AJF500JNONNNNN	
650	715	630	590	649	885	560	460	690	828	450	20G11JF590JNONNNNN	9 ⁽⁵⁾
710	781	710	650	715	975	630	500	750	900	500	20G11JF650JNONNNNN	
790	869	800	710	781	1065	710	590	885	1062	560	20G11JF710JNONNNNN	
860	946	850	765	842	1148	750	650	975	1170	630	20G11JF765JNONNNNN	
960	1056	900	795	875	1193	800	750	1125	1350	710	20G11JF795JNONNNNN	
1020	1122	1000	960	1056	1440	900	795	1193	1431	800	20G11JF960JNONNNNN	
1150	1265	1100	1040	1144	1560	1000	865	1298	1557	900	20G11JF1K0JNONNNNN	10 ⁽⁵⁾
1485	1634	1500	1400	1540	2100	1400	1160	1740	2088	1120	20G11JF1K4JNONNNNN	

(1) Light Duty rating only available on Frame 8...10 drives. Light Duty allows 110% overload for 1 minute, and does not have a 3 second overload rating.

(2) The 5th character determines Input Type; "1" = AC input with precharge and DC terminals, and "A" = AC input with precharge and no DC terminals. For DC input drives, see [DRIVES-SG001](#), the PowerFlex Common Bus Configuration Selection Guide.

(3) The 11th character determines default Filtering and Common Mode Cap jumper configuration; "J" = Installed, and "A" = Removed.

(4) The 12th character determines whether an internal dynamic braking IGBT is included; "A" = Internal dynamic braking transistor installed, and "N" = No internal dynamic braking transistor.

(5) A roll-out cart is required with Frame 8...10 drives to assist with power wiring and cabinet mounting. Refer to page 131.

Flange Mount (Front: IP20, NEMA/UL Type Open; Back/Heatsink: IP66, NEMA/UL Type 4X)

Note: Frame 6...7 IP00, NEMA Type Open drives can be converted to a flange mount drive (Back/Heatsink: IP66, NEMA/UL Type 4X) with an optional user installed flange kit (20-750-FLNG4-F6 for Frame 6, and 20-750-FLNG4-F7 for Frame 7).

See page 100 for 690V, Frame 6...7 IP00, NEMA Type Open drives.

PowerFlex 755 Floor Mount Drives for Open Frame Designs

Floor mount, open frame drives are for applications that require power ranges from 215 kW to 1500kW (250 Hp...2000 Hp) and are contained within an enclosure of your choosing. These drives use the same drive unit(s) as standard IP20 and IP54 product. Open Frame applications can accommodate either AC input or Common Bus DC input systems.

Floor mount, open frame drives can also be horizontally mounted, with derating. Refer to publication [750-IN020](#) for details.

To order an IP00 drive:

1. Using the tables that follow, locate your desired drive output values.
2. Select the Base Drive Catalog Number for your desired output values.
3. Note the Quantity Required.
4. Order the specified quantity (1, 2, or 3) of the Base Drive Catalog Number.
5. Refer to page 130 for option kits and the PowerFlex 755 IP00 NEMA/UL Open Type Drive Installation Instructions, publication [750-IN020](#) for installation details.

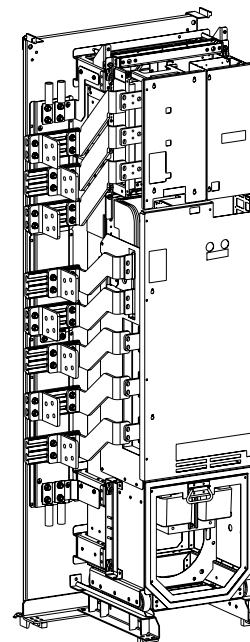

380...400V AC, Three-phase and 540V DC Input Drives⁽¹⁾

Light Duty		Normal Duty		Heavy Duty		Base Drive Cat. No. ⁽²⁾	Quantity Required	Equivalent Frame Size
Output Amps	kW	Output Amps	kW	Output Amps	kW			
Cont.		Cont.		Cont.				
540	315	460	250	385	200	20G11TC460JNONNNNN	1	8
585	315	540	315	456	250	20G11TC540JNONNNNN		
612	355	567	315	472	250	20G11TC567JNONNNNN		
750	400	650	355	540	315	20G11TC650JNONNNNN		
796	450	750	400	585	315	20G11TC750JNONNNNN		
832	450	770	400	642	355	20G11TC770JNONNNNN		
1040	560	910	500	750	400	20G11TC460JNONNNNN	2	9
1090	630	1040	560	880	500	20G11TC540JNONNNNN		
1175	710	1090	630	910	500	20G11TC567JNONNNNN		
1465	800	1175	710	1040	560	20G11TC650JNONNNNN		
1480	850	1465	800	1090	630	20G11TC750JNONNNNN		
1600	900	1480	850	1175	710	20G11TC770JNONNNNN		
1715	1000	1590	900	1325	710	20G11TC567JNONNNNN	3	10
2330	1400	2150	1250	1800	1000	20G11TC770JNONNNNN		

(1) A roll-out cart is required with Frame 8...10 drives to assist with power wiring and cabinet mounting. Refer to page 131.

(2) The 11th character determines default Filtering and Common Mode Cap jumper configuration. "J" = Installed, "A" = Removed.

PowerFlex 755 Floor Mount Drives for Open Frame Designs (continued)

480V AC, Three-phase and 650V DC Input Drives⁽¹⁾

Light Duty (-LD)		Normal Duty (-ND)		Heavy Duty (-HD)		Base Drive Cat. No.	Quantity Required	Equivalent Frame Size
Output Amps	Hp	Output Amps	Hp	Output Amps	Hp			
Cont.		Cont.		Cont.				
485	400	430	350	370	300	20G11TD430JNONNNNN	1	8
545	450	485	400	414	350	20G11TD485JNONNNNN		
590	500	545	450	454	350	20G11TD545JNONNNNN		
710	600	617	500	485	400	20G11TD617JNONNNNN		
765	650	710	600	545	450	20G11TD710JNONNNNN		
800	700	740	650	617	500	20G11TD740JNONNNNN		
960	800	800	700	710	600	20G11TD430JNONNNNN	2	9
1045	900	960	800	795	700	20G11TD485JNONNNNN		
1135	1000	1045	900	800	750	20G11TD545JNONNNNN		
1365	1100	1135	1000	960	800	20G11TD617JNONNNNN		
1420	1250	1365	1100	1045	900	20G11TD710JNONNNNN		
1540	1350	1420	1250	1135	1000	20G11TD740JNONNNNN		
1655	1500	1525	1350	1270	1100	20G11TD545JNONNNNN	3	10
2240	2000	2070	1750	1730	1650	20G11TD740JNONNNNN		

(1) A roll-out cart is required with Frame 8...10 drives to assist with power wiring and cabinet mounting. Refer to page 131.

600V AC, Three-phase and 810V DC Input Drives⁽¹⁾

Light Duty (-LD)		Normal Duty (-ND)		Heavy Duty (-HD)		Base Drive Cat. No.	Quantity Required	Equivalent Frame Size
Output Amps	Hp	Output Amps	Hp	Output Amps	Hp			
Cont.		Cont.		Cont.				
355	350	295	300	272	250	20G11TE295JNONNNNN	1	8
395	400	355	350	295	300	20G11TE355JNONNNNN		
435	450	395	400	329	350	20G11TE395JNONNNNN		
460	500	435	450	355	350	20G11TE435JNONNNNN		
510	500	460	500	395	400	20G11TE460JNONNNNN		
545	550	510	500	425	450	20G11TE510JNONNNNN		
690	700	595	600	510	500	20G11TE295JNONNNNN	2	9
760	800	630	700	595	600	20G11TE355JNONNNNN		
835	900	760	800	630	700	20G11TE395JNONNNNN		
900	950	825	900	700	750	20G11TE435JNONNNNN		
980	1000	900	950	760	800	20G11TE460JNONNNNN		
1045	1100	980	1000	815	900	20G11TE510JNONNNNN		
1220	1200	1110	1100	920	1000	20G11TE395JNONNNNN	3	10
1530	1500	1430	1400	1190	1250	20G11TE510JNONNNNN		

(1) A roll-out cart is required with Frame 8...10 drives to assist with power wiring and cabinet mounting. Refer to page 131.

PowerFlex 755 Floor Mount Drives for Open Frame Designs (continued)

690V AC, Three-phase and 932V DC Input Drives⁽¹⁾

Light Duty (-LD)		Normal Duty (-ND)		Heavy Duty (-HD)		Base Drive Cat. No. ⁽²⁾	Quantity Required	Equivalent Frame Size
Output Amps	kW	Output Amps	kW	Output Amps	kW			
Cont.		Cont.		Cont.				
330	315	265	250	215	200	20G11TF265JNONNNNN	1	8
370	355	330	315	265	250	20G11TF330JNONNNNN		
410	400	370	355	308	300	20G11TF370JNONNNNN		
460	450	415	400	370	355	20G11TF415JNONNNNN		
500	500	460	450	375	375	20G11TF460JNONNNNN		
530	530	500	500	413	400	20G11TF500JNONNNNN		
650	630	590	560	460	450	20G11TF265JNONNNNN	2	9
710	710	650	630	500	500	20G11TF330JNONNNNN		
790	800	710	710	590	560	20G11TF370JNONNNNN		
860	850	765	750	650	630	20G11TF415JNONNNNN		
960	900	795	800	750	710	20G11TF460JNONNNNN		
1020	1000	960	900	795	800	20G11TF500JNONNNNN		
1150	1100	1040	1000	865	900	20G11TF370JNONNNNN	3	10
1485	1500	1400	1400	1160	1120	20G11TF500JNONNNNN		

(1) A roll-out cart is required with Frame 8...10 drives to assist with power wiring and cabinet mounting. Refer to 131.

(2) The 11th character determines default Filtering and Common Mode Cap jumper configuration. "J" = Installed, "A" = Removed.

PowerFlex 755 Floor Mount Drives for Open Frame Designs (continued)

Kits listed here provide electrical connection, mounting and ventilation provisions along with the control pod and its corresponding cables for PowerFlex 755 Floor Mount Open Frame designs. Other accessories shown include the rollout cart and EMC cores. Refer to publication [750-IN020](#) for details.

PowerFlex 755 IP00 Option Kits

Description	Required?	Frame 8		Frame 9		Frame 10				
		Cat. No.	Qty.	Cat. No.	Qty.	Cat. No.	Qty.			
Field Termination, Converter, AC Input ⁽⁵⁾	Recommended	20-750-BUS2-F8	1	20-750-BUS2-F9	1	20-750-BUS2-F10	1			
Field Termination, Inverter, AC Output ⁽⁵⁾		20-750-BUS3-F8		20-750-BUS3-F9		20-750-BUS3-F10				
Field Termination, Inverter, DC Bus		20-750-BUS4-F8		20-750-BUS4-F9		20-750-BUS4-F10				
Field Termination, DC Input, Common Bus Precharge ⁽¹⁾⁽²⁾⁽⁵⁾		20-750-BUS5-F8		20-750-BUS5-F9		20-750-BUS5-F10				
Pod, Bucket Assembly	Required ⁽⁴⁾	20-750-POD1-F8	1	20-750-POD1-F8	1	20-750-POD1-F8	1			
Pod, Cable, 24 Volt Supply ⁽⁴⁾		20-750-PH1-F8		20-750-PH2-F9		20-750-PH3-F10				
Cable, Fiber Optic, 560 mm (22 in.) ⁽⁴⁾		20-750-FCBL1-F8		—		—		—	—	
Cable, Fiber Optic, 2.8 m (110 in.) ⁽⁴⁾		—		—		20-750-FCBL1-F10		2	20-750-FCBL1-F10	3
Transceiver, Fiber Optic		—		—		SK-R1-FTR1-F8		1	SK-R1-FTR1-F8	2
POD, Remote Mounting Kit	Optional	20-750-RPD1-F8	1	20-750-RPD1-F8	2	20-750-RPD1-F8	3			
Mounting Kit, Back Panel	Recommended	20-750-MNT2-F8	1	20-750-MNT2-F9	1	20-750-MNT2-F10	1			
Mounting Kit, Floor		20-750-MNT3-F8		20-750-MNT3-F9		20-750-MNT3-F10				
Duct, Top Outlet		20-750-DUCT2-F8		20-750-DUCT2-F8		2		20-750-DUCT2-F8	3	
Duct, Bottom Inlet ⁽⁶⁾		20-750-DUCT4-F8		20-750-DUCT4-F8		1		20-750-DUCT4-F8	1	
Roll-Out Cart		20-750-CART1-F8		20-750-CART1-F8		1		20-750-CART1-F8	1	
Control Power Circuit Breaker ⁽¹⁾		1489-A2D130		1489-A2D130		2		1489-A2D130	3	
Control Power Circuit Breaker Lock ⁽¹⁾	1489-AALOA	1489-AALOA	1	1489-AALOA	1					
EMC Core, Converter Input, AC Input	Optional	20-750-EMCBUS1-F8	1	20-750-EMCBUS1-F8	1	20-750-EMCBUS1-F8	1			
EMC Core, Inverter Output		20-750-EMCCM1-F8		20-750-EMCCM1-F8		20-750-EMCCM1-F8				

(1) Common DC input drives only.

(2) EMC input cores are included with the 20-750-BUS5-Fx kits.

(3) 24 volt supply cable is included with each Frame 8 drive unit.

(4) 20-750-PH1-Fx and 20-750-FBCL1-Fx kits are used if the Control Pod is mounted in the drive. If the Control Pod is to be remote mounted (up to 23 m or 75 ft away), order a 20-750-RPD1-Fx kit instead.

(5) Input and Output Field Termination kits required to meet UL certification

(6) Only required when air inlet from bottom of cabinet is required

Power Options for PowerFlex 755 Floor Mount, AC Input Drives

Pre-engineered, factory installed options are available with the PowerFlex 755 floor mount drives, which includes disconnects, reactors, contactors, MCC bus and wiring only bays.

To configure a catalog number for a floor-mount drive with options, perform the following steps:

1. Select the base drive catalog number from the tables on pages 108...111. Drive selection is based on the output amps and corresponding system overload(s) required by the application.
2. Select the duty rating. See the Required Options table on page 107 for duty rating details. For example: 21G1ALC460JN0NNNNN-**LD**.
3. Select the desired enclosure type as described on pages 108...111. For example: 21G1AL**C**460JN0NNNNN-LD.
4. Select Power Disconnect and/or Wire Only Bay option from the Required Options table on page 107. Add the desired option codes to the end of the base drive catalog number, separating each option code with a dash. For example: 21G1ALC460JN0NNNNN-LD-**P3**.
5. If options listed in the Additional Options table on page 107 are required, add the option code(s) to the end of the drive catalog number, separating each code with a dash. For example: 21G1ALC460JN0NNNNN-LD-P3-**P11**.

Note: A 600 mm wide cabinet bay is added to the right of the drive cabinet(s) to house the power options. The Wiring Only Bay option (-P14) also adds a 600 mm wide cabinet bay to the right of the drive cabinet(s).

Frame 8 with Power Option Bay

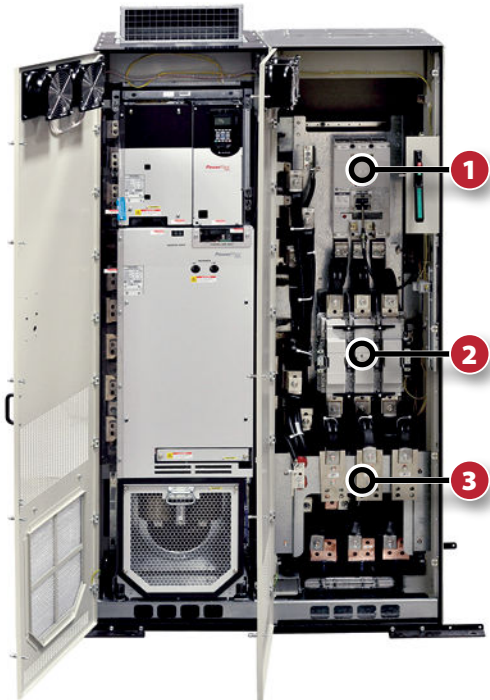

Input power landed on line-side of power disconnect.

Frame 9 with Power Option Bay

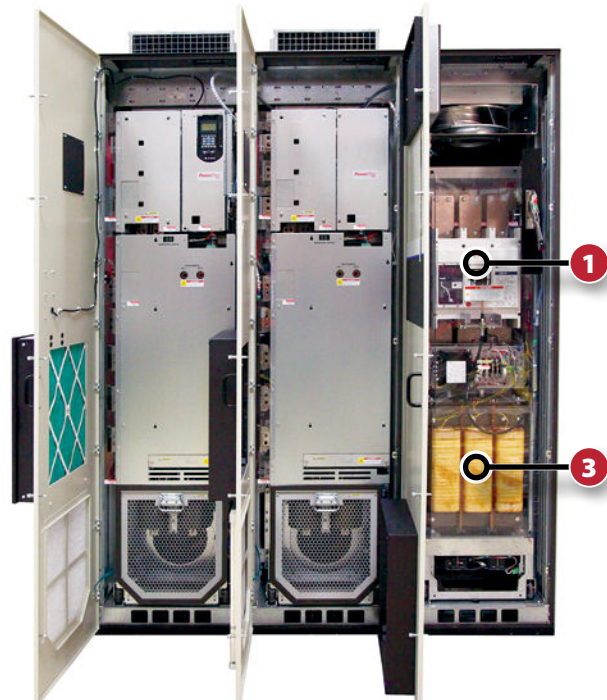

Input power landed behind circuit breaker, which is accessed by extracting rollout chassis.

1 **Power Disconnect**
Options -P3 or -P5
See Required Options on page 107.

2 **Contactor**
Options -P11 or -P12
See Additional Options on page 107.

3 **Reactor**
Options -L1, -L2, -L3, or -L4
See Additional Options on page 107.

Power Options for PowerFlex 755 Floor Mount, AC Input Drives (continued)

Required Options

Type	Option		Frame Size	Description
System Overload Duty Cycle ⁽¹⁾⁽²⁾	LD	Light Duty	8...10	100% continuous current, 110% current for 1 minute.
	ND	Normal Duty		100% continuous current, 110% current for 1 minute, 150% for 3 seconds.
	HD	Heavy Duty		100% continuous current, 150% current for 1 minute, 180% for 3 seconds.
Power Disconnect ⁽¹⁾	P3	Input Thermal Magnetic Circuit Breaker	8...10 ⁽³⁾	This option is for disconnecting drive power. An Allen-Bradley 140G Molded Case Circuit Breaker is provided. Frame 8 drives include flange style handle operators that are door interlocking and padlockable. Frame 9 drive circuit breakers are pushbutton actuated with door interlocks and are padlockable.
	P5	Input Non-Fused Molded Case Disconnect Switch	8 Only	This option is for disconnecting drive power. An Allen-Bradley 140G Molded Case Switch is provided. All switches include flange style handle operators that are door interlocking and padlockable. Note: PowerFlex 755 Frame 8 converter modules input fuses installed as standard equipment do not provide branch protection.
Wiring Only Bay	P14	Wiring Only Bay	8...10	This option identifies that an extra bay is provided for wiring the drive. This option extends the drive power bus from the drive bay into the option bay, making field connection options more flexible. No drive input protection is supplied with this option selection. If desired, a power option bay with a disconnect option can be added to the wiring bay. Documentation to reflect input disconnection and protection is customer supplied. See page 130 for more information on power cable entry/exit locations.

(1) Only one option of this type can be selected.

(2) See following selection tables for specific rating information.

(3) Frame 10 ordered via Engineered-To-Order (ETO) process.

Additional Options

Type	Option		Applicable Frame Size	Description
Contactors ⁽⁴⁾⁽⁵⁾	P11	Input Contactor	8 Only	A contactor is provided between the AC line and the drive. The contactor is controlled by customer supplied 120V AC (480V input) or 230V AC (400V input) remote contact closure logic. A terminal block for control is provided for customer use, and is wired to 1 N.O. and 1 N.C. auxiliary contact on the contactor. Important: The P11 option 'Alternate Contact Circuit' is not intended to be used as a Start/Stop circuit.
	P12	Output Contactor		A contactor is provided between the drive output and the motor. The contactor is controlled by customer supplied 120V AC (480V input) or 230V AC (400V input) remote contact closure logic. A terminal block for control is provided for customer use and is wired to 1 N.O. and 1 N.C. auxiliary contact on the contactor. Note: As an alternative to an output contactor, certain safety applications can be satisfied using the PowerFlex 750-Series Safe Torque Off Option Card (Cat. No. 20-750-S). Safe Torque Off is ideal for safety related applications requiring removal of rotational power to the motor without removing power from the drive. Safe Torque Off functionality offers the benefit of quick start-up after a demand on the safety system and helps reduce wear from repetitive start-up. It also provides safety ratings up to and including SIL3, PL _e , and CAT 3.
Reactors ⁽⁴⁾⁽⁶⁾	L1	3% Input Reactor	8...9	Provides an open core drive input line reactor that mounts inside the power bay option enclosure. Typical impedance is 3%.
	L2	3% Output Reactor		Provides an open core drive output load reactor, which mounts inside the power bay option enclosure. Typical impedance is 3%.
	L3	5% Input Reactor	8 Only	Provides an open core drive input line reactor that mounts inside the power bay option enclosure. Typical impedance is 5%.
	L4	5% Output Reactor		Provides an open core drive output load reactor, which mounts inside the power bay option enclosure. Typical impedance is 5%.
MCC Power Bus ⁽⁴⁾⁽⁷⁾	P20	1250 Amp Bus	8...10	Provides a 1250 Amp MCC Bus.
	P22	2000 Amp Bus		Provides a 2000 Amp MCC Bus.
	P24	3000 Amp Bus		Provides a 3000 Amp MCC Bus.
Auxiliary Power	X1	Auxiliary Transformer	8 Only	Auxiliary transformer providing 500VA. Available as an option on frame 8, IP20 units. This option is standard on all other cabinet configurations.

(4) Only one option of this type can be selected.

(5) Contactor options are not available for systems with MCC power bus.

(6) To accommodate a larger reactor, an 800 mm deep cabinet must be selected for the following Frame 8 drives; C750, C770, D710, D740 at light duty (LD), and C770 at normal-duty (ND).

(7) MCC bus is connected to the line side of the disconnect, as delivered from the factory.

Power Options for PowerFlex 755 Floor Mount, AC Input Drives (continued)

Enclosure Type Selections

Code	Description
B	600 mm deep, IP20/NEMA 1, standard color (RAL 7032)
L	800 mm deep, IP20/NEMA 1, standard color (RAL 7032)
P	800 mm deep, IP20/NEMA 1, with Motor Control Center (MCC) power bus option, standard color (RAL 7032)
W	800 mm deep, IP20/NEMA 1, with MCC power bus option, CENTERLINE 2100 gray (ASA49)
J	800 mm deep, IP54/NEMA 12, standard color (RAL 7032)
K	800 mm deep, IP54/NEMA 12, with MCC power bus option, standard color (RAL 7032)
Y	800 mm deep, IP54/NEMA 12, with MCC power bus option, CENTERLINE 2100 gray (ASA49)

380...400V AC, Three-phase Input Drives⁽¹⁾⁽²⁾

Light Duty (-LD)			Normal Duty (-ND)				Heavy Duty (-HD)				Base Drive Cat. No. ⁽³⁾⁽⁴⁾⁽⁵⁾	Frame Size	
Output Amps			kW	Output Amps			kW	Output Amps					kW
Cont.	1 min	3 s		Cont.	1 min	3 s		Cont.	1 min	3 s			
540	594	—	315	460	506	693	250	385	578	693	200	21G1A*C460JNONNNNN	8
585	644		315	540	594	821	315	456	684	821	250	21G1A*C540JNONNNNN	
612	673		355	567	624	851	315	472	708	851	250	21G1A*C567JNONNNNN	
750	825		400	650	715	975	355	540	810	975	315	21G1A*C650JNONNNNN	
796	876		450	750	825	1125	400	585	878	1125	315	21G1A*C750JNONNNNN	
832	915		450	770	847	1155	400	642	963	1155	355	21G1A*C770JNONNNNN	
1040	1144		560	910	1001	1365	500	750	1125	1365	400	21G11*C910JNONNNNN	
1090	1199		630	1040	1144	1584	560	880	1320	1584	500	21G11*C1K0JNONNNNN	
1175	1293		710	1090	1199	1638	630	910	1365	1638	500	21G11*C1K1JNONNNNN	
1465	1612		800	1175	1293	1872	710	1040	1560	1872	560	21G11*C1K2JNONNNNN	
1480	1628		850	1465	1612	2198	800	1090	1635	2198	630	21G11*C1K4JNONNNNN	
1600	1760		900	1480	1628	2220	850	1175	1763	2220	710	21G11*C1K5JNONNNNN	
1715	1887		1000	1590	1749	2385	900	1325	1988	2385	710	21G11*C1K6JNONNNNN	10
2330	2563		1400	2150	2365	3225	1250	1800	2700	3225	1000	21G11*C2K1JNONNNNN	

(1) Contact your local Rockwell Automation sales office or Allen-Bradley distributor for availability.

(2) A Roll-out Cart is required with Frame 8...10 drives to assist with power wiring and cabinet mounting. Refer to page 131.

(3) The 5th character determines Input Type. "1" = AC input with precharge and DC terminals. "A" = AC input with precharge and no DC terminals. For DC input drives, see [DRIVES-SG001](#), the PowerFlex Common Bus Configuration Selection Guide.

(4) The 11th character determines default Filtering and Common Mode Cap jumper configuration. "J" = Installed, "A" = Removed.

(5) The 6th character (designated by an * in this table) determines enclosure type. For that selection, refer to the Enclosure Type Selections table on this page.

Power Options for PowerFlex 755 Floor Mount, AC Input Drives (continued)

Enclosure Type Selections

Code	Description
B	600 mm deep, IP20/NEMA 1, standard color (RAL 7032)
L	800 mm deep, IP20/NEMA 1, standard color (RAL 7032)
P	800 mm deep, IP20/NEMA 1, with Motor Control Center (MCC) power bus option, standard color (RAL 7032)
W	800 mm deep, IP20/NEMA 1, with MCC power bus option, CENTERLINE 2100 gray (ASA49)
J	800 mm deep, IP54/NEMA 12, standard color (RAL 7032)
K	800 mm deep, IP54/NEMA 12, with MCC power bus option, standard color (RAL 7032)
Y	800 mm deep, IP54/NEMA 12, with MCC power bus option, CENTERLINE 2100 gray (ASA49)

480V AC, Three-phase Input Drives⁽¹⁾⁽²⁾

Light Duty			Normal Duty				Heavy Duty				Base Drive Cat. No. ⁽³⁾⁽⁴⁾⁽⁵⁾	Frame Size	
Output Amps			Hp	Output Amps			Hp	Output Amps					Hp
Cont.	1 min	3 s		Cont.	1 min	3 s		Cont.	1 min	3 s			
485	534	—	400	430	473	666	350	370	555	666	300	21G1A*D430JNONNNNN	8
545	600		450	485	534	745	400	414	621	745	350	21G1A*D485JNONNNNN	
590	649		500	545	600	818	450	454	681	818	350	21G1A*D545JNONNNNN	
710	781		600	617	679	926	500	485	728	926	400	21G1A*D617JNONNNNN	
765	842		650	710	781	1065	600	545	818	1065	450	21G1A*D710JNONNNNN	
800	880		700	740	817	1110	650	617	926	1110	500	21G1A*D740JNONNNNN	
960	1056		800	800	880	1278	700	710	1065	1278	600	21G11*D800JNONNNNN	
1045	1150		900	960	1056	1440	800	795	1193	1440	700	21G11*D960JNONNNNN	
1135	1249		1000	1045	1150	1568	900	800	1200	1568	750	21G11*D1K0JNONNNNN	
1365	1502		1100	1135	1249	1728	1000	960	1440	1728	800	21G11*D1K2JNONNNNN	
1420	1562		1250	1365	1502	2048	1100	1045	1568	2048	900	21G11*D1K3JNONNNNN	
1540	1694		1350	1420	1562	2130	1250	1135	1703	2130	1000	21G11*D1K4JNONNNNN	
1655	1821		1500	1525	1678	2288	1350	1270	1905	2288	1100	21G11*D1K5JNONNNNN	10
2240	2464		2000	2070	2277	3105	1750	1730	2595	3105	1650	21G11*D2K0JNONNNNN	

(1) Contact your local Rockwell Automation sales office or Allen-Bradley distributor for availability.

(2) A Roll-out Cart is required with Frame 8...10 drives to assist with power wiring and cabinet mounting. Refer to page 131.

(3) The 5th character determines Input Type. "1" = AC input with precharge and DC terminals. "A" = AC input with precharge and no DC terminals. For DC input drives, see [DRIVES-SG001](#), the PowerFlex Common Bus Configuration Selection Guide.

(4) The 11th character determines default Filtering and Common Mode Cap jumper configuration. "J" = Installed, "A" = Removed.

(5) The 6th character (designated by an * in this table) determines enclosure type. For that selection, refer to the Enclosure Type Selections table on this page.

Power Options for PowerFlex 755 Floor Mount, AC Input Drives (continued)

Enclosure Type Selections

Code	Description
B	600 mm deep, IP20/NEMA 1, standard color (RAL 7032)
L	800 mm deep, IP20/NEMA 1, standard color (RAL 7032)
P	800 mm deep, IP20/NEMA 1, with Motor Control Center (MCC) power bus option, standard color (RAL 7032)
W	800 mm deep, IP20/NEMA 1, with MCC power bus option, CENTERLINE 2100 gray (ASA49)
J	800 mm deep, IP54/NEMA 12, standard color (RAL 7032)
K	800 mm deep, IP54/NEMA 12, with MCC power bus option, standard color (RAL 7032)
Y	800 mm deep, IP54/NEMA 12, with MCC power bus option, CENTERLINE 2100 gray (ASA49)

600V AC, Three-phase Input Drives⁽¹⁾⁽²⁾

Light Duty			Normal Duty				Heavy Duty				Base Drive Cat. No. ⁽³⁾⁽⁴⁾⁽⁵⁾	Frame Size	
Output Amps			Output Amps				Output Amps						
Cont.	1 min	3 s	Hp	Cont.	1 min	3 s	Hp	Cont.	1 min	3 s			Hp
355	391	—	350	295	325	490	300	272	408	490	250	21G1A*E295JNONNNNN	8
395	435		400	355	391	533	350	295	443	533	300	21G1A*E355JNONNNNN	
435	479		450	395	435	593	400	329	494	593	350	21G1A*E395JNONNNNN	
460	506		500	435	479	639	450	355	533	639	350	21G1A*E435JNONNNNN	
510	561		500	460	506	711	500	395	593	711	400	21G1A*E460JNONNNNN	
545	600		550	510	561	765	500	425	638	765	450	21G1A*E510JNONNNNN	
690	759		700	595	655	918	600	510	765	918	500	21G11*E595JNONNNNN	
760	836		800	630	693	1071	700	595	893	1071	600	21G11*E630JNONNNNN	
835	919		900	760	836	1140	800	630	945	1140	700	21G11*E760JNONNNNN	
900	990		950	825	908	1260	900	700	1050	1260	750	21G11*E825JNONNNNN	
980	1078		1000	900	990	1368	950	760	1140	1368	800	21G11*E900JNONNNNN	
1045	1150		1100	980	1078	1470	1000	815	1223	1470	900	21G11*E980JNONNNNN	
1220	1342		1200	1110	1221	1665	1100	920	1380	1665	1000	21G11*E1K1JNONNNNN	10
1530	1683		1500	1430	1573	2145	1400	1190	1785	2145	1250	21G11*E1K4JNONNNNN	

(1) Contact your local Rockwell Automation sales office or Allen-Bradley distributor for availability.

(2) A Roll-out Cart is required with Frame 8...10 drives to assist with power wiring and cabinet mounting. Refer to page 131.

(3) The 5th character determines Input Type. "1" = AC input with precharge and DC terminals. "A" = AC input with precharge and no DC terminals. For DC input drives, see [DRIVES-SG001](#), the PowerFlex Common Bus Configuration Selection Guide.

(4) The 11th character determines default Filtering and Common Mode Cap jumper configuration. "J" = Installed, "A" = Removed.

(5) The 6th character (designated by an * in this table) determines enclosure type. For that selection, refer to the Enclosure Type Selections table on this page.

Power Options for PowerFlex 755 Floor Mount, AC Input Drives (continued)

Enclosure Type Selections

Code	Description
B	600 mm deep, IP20/NEMA 1, standard color (RAL 7032)
L	800 mm deep, IP20/NEMA 1, standard color (RAL 7032)
P	800 mm deep, IP20/NEMA 1, with Motor Control Center (MCC) power bus option, standard color (RAL 7032)
W	800 mm deep, IP20/NEMA 1, with MCC power bus option, CENTERLINE 2100 gray (ASA49)
J	800 mm deep, IP54/NEMA 12, standard color (RAL 7032)
K	800 mm deep, IP54/NEMA 12, with MCC power bus option, standard color (RAL 7032)
Y	800 mm deep, IP54/NEMA 12, with MCC power bus option, CENTERLINE 2100 gray (ASA49)

690V AC, Three-phase Input Drives⁽¹⁾⁽²⁾

Light Duty			Normal Duty				Heavy Duty				Base Drive Cat. No. ⁽³⁾⁽⁴⁾⁽⁵⁾	Frame Size	
Output Amps			Output Amps				Output Amps						
Cont.	1 min	3 s	kW	Cont.	1 min	3 s	kW	Cont.	1 min	3 s			kW
330	363	—	315	265	292	375	250	215	323	375	200	21G1A*F265JNONNNNN	8
370	407		355	330	363	473	315	265	398	473	250	21G1A*F330JNONNNNN	
410	451		400	370	407	555	355	308	462	555	300	21G1A*F370JNONNNNN	
460	506		450	415	457	639	400	370	555	639	355	21G1A*F415JNONNNNN	
500	550		500	460	506	675	450	375	563	675	375	21G1A*F460JNONNNNN	
530	583		530	500	550	750	500	413	620	750	400	21G1A*F500JNONNNNN	
650	715		630	590	649	885	560	460	690	885	450	21G11*F590JNONNNNN	9
710	781		710	650	715	975	630	500	750	975	500	21G11*F650JNONNNNN	
790	869		800	710	781	1065	710	590	885	1065	560	21G11*F710JNONNNNN	
860	946		850	765	842	1170	750	650	975	1170	630	21G11*F765JNONNNNN	
960	1056		900	795	875	1350	800	750	1125	1350	710	21G11*F795JNONNNNN	
1020	1122		1000	960	1056	1440	900	795	1193	1440	800	21G11*F960JNONNNNN	
1150	1265		1100	1040	1144	1560	1000	865	1298	1560	900	21G11*F1K0JNONNNNN	10
1485	1634		1500	1400	1540	2100	1400	1160	1740	2100	1120	21G11*F1K4JNONNNNN	

(1) Contact your local Rockwell Automation sales office or Allen-Bradley distributor for availability.

(2) A Roll-out Cart is required with Frame 8...10 drives to assist with power wiring and cabinet mounting. Refer to page 131.

(3) The 5th character determines Input Type. "1" = AC input with precharge and DC terminals. "A" = AC input with precharge and no DC terminals. For DC input drives, see [DRIVES-SG001](#), the PowerFlex Common Bus Configuration Selection Guide.

(4) The 11th character determines default Filtering and Common Mode Cap jumper configuration. "J" = Installed, "A" = Removed.

(5) The 6th character (designated by an * in this table) determines enclosure type. For that selection, refer to the Enclosure Type Selections table on this page.

Connect to a CENTERLINE Motor Control Center (MCC)

To select the splice kit best suited for your application, determine the following.

1. Are you connecting to a CENTERLINE® 2100 or CENTERLINE 2500 MCC?
2. While facing the front of the PowerFlex 755 drive, decide to which drive side that you want to connect.
3. Are you connecting PowerFlex 755 floor mount drives together, or are you connecting a PowerFlex 755 floor mount drive to a CENTERLINE MCC?

If you are connecting PowerFlex 755 floor mount drives together or if you are connecting a PowerFlex 755 floor mount drive to a CENTERLINE 2500 MCC, then use PowerFlex 755 CENTERLINE 2500 Splice Kits. Otherwise, use PowerFlex 755 CENTERLINE 2100 Splice Kits.

NOTE: A splice kit contains three splice plates.

PowerFlex 755 CENTERLINE 2100 Splice Kits

A complete installation requires one transition section and one bus bar splicing kit. Splicing kits include all necessary hardware to complete connection of all three-phases.

Mounting Channel	Busbar Position ⁽¹⁾	Amp Rating	Left-side Kit Cat No.	Right-side Kit Cat No.	Frame Sizes
N/A	Transition section ⁽²⁾	N/A	20-750-XSEC-LH-20G	20-750-XSEC-RH-20G	8...10
For use with MCCs that have 1.5 in. mounting channels	Standard	1200	20-750-XBUS-LHNB-1200	20-750-XBUS-RHNB-1200	8...10
		2000	20-750-XBUS-LHNB-2000	20-750-XBUS-RHNB-2000	
		3000	20-750-XBUS-LHNB-3000	20-750-XBUS-RHNB-3000	
	Bumped back	1200	20-750-XBUS-LHBB-1200	20-750-XBUS-RHBB-1200	
		2000	20-750-XBUS-LHBB-2000	20-750-XBUS-RHBB-2000	
		3000	20-750-XBUS-LHBB-3000	20-750-XBUS-RHBB-3000	
For use with MCCs that do not have mounting channels	Standard	1200	20-750-XBUS-LLNB-1200	20-750-XBUS-RLNB-1200	8...10
		2000	20-750-XBUS-LLNB-2000	20-750-XBUS-RLNB-2000	
		3000	20-750-XBUS-LLNB-3000	20-750-XBUS-RLNB-3000	
	Bumped back	1200	20-750-XBUS-LLBB-1200	20-750-XBUS-RLBB-1200	
		2000	20-750-XBUS-LLBB-2000	20-750-XBUS-RLBB-2000	
		3000	20-750-XBUS-LLBB-3000	20-750-XBUS-RLBB-3000	

(1) All busbar positions are 20 in. deep.

(2) Hardware is included to install the optional 1.5 in. mounting channel.

PowerFlex 755 CENTERLINE 2500 Splice Kits

Splicing kits include all necessary hardware to complete connection of all three-phases.

Description	Cat No.	Frame Sizes
1200A Splice Kit to connect right side of drive to a CENTERLINE® 2500 cabinet	20-750-MBUSR1-1200	8...10
2000A Splice Kit to connect right side of drive to a CENTERLINE 2500 cabinet	20-750-MBUSR1-2000	
3000A Splice Kit to connect right side of drive to a CENTERLINE 2500 cabinet	20-750-MBUSR1-3200	
1200A Splice Kit to connect multiple Frame 8...10 drives or to connect left side of drive to a CENTERLINE 2500 cabinet	20-750-MBUSL1-1200	
2000A Splice Kit to connect multiple Frame 8...10 drives or to connect left side of drive to a CENTERLINE 2500 cabinet	20-750-MBUSL1-2000	
3000A Splice Kit to connect multiple Frame 8...10 drives or to connect left side of drive to a CENTERLINE 2500 cabinet	20-750-MBUSL1-3200	

PowerFlex 755 Empty Option Bay

This section is for applications with a PowerFlex 755 floor mount drive that need additional cabinet space. These added cabinets provide an elegant packaging option when expanding a PowerFlex 755, frame 8, 9, or 10 lineup. All Empty Option Bay cabinets match the standard color (RAL 7032) of the PowerFlex 755 Floor Mount Drive. Each Empty Option Bay includes a sub-panel. Reference publication For installation details, see publication [750-IN031](#).

The Right Mount Bus Bar kits listed below can only be installed to the right of a PowerFlex 755 Floor Mount Drive, when facing the front of the drive. If the application requires mounting the Empty Option Bay to the left of the PowerFlex 755 Floor Mount Drive, then the Rear Drive Bus Bar can be installed behind the drive unit(s). Power cabling is landed on the Rear Drive Bus Bars and passed through the cabinet side wall to the Empty Option Bay.

The Option Bay Hardware Kit listed below contains the door handle, an air barrier (for use between cabinets) and a door overlay label. One is required for each option bay.

PowerFlex 755 Empty Option Bay⁽¹⁾

Description	Cat. No.	Frame Sizes
Option Bay, 600 mm wide by 600 mm deep, Beige ⁽³⁾	20-750-PBAY-66	8...10
Option Bay, 800 mm wide by 600 mm deep, Beige ⁽³⁾	20-750-PBAY-86	
Option Bay, 1200 mm wide by 600 mm deep, Beige ⁽³⁾	20-750-PBAY-126	
Option Bay, 600 mm wide by 800 mm deep, Beige ⁽⁴⁾	20-750-PBAY-68	
Option Bay, 800 mm wide by 800 mm deep, Beige ⁽⁴⁾	20-750-PBAY-88	
Option Bay, 1200 mm wide by 800 mm deep, Beige ⁽⁴⁾	20-750-PBAY-128	
Option Bay Hardware Kit (one kit is required for each cabinet selected) ⁽⁵⁾	20-750-PBAY-HWD-1	
Option Bay Seal Kit, IP54	20-750-PBAY-IP54	
Empty Bay, RH Bus Bar, 975 A, continuous ⁽²⁾	20-750-PBAY-RHBB-975	
Empty Bay, RH Bus Bar, 1235 A, continuous ⁽²⁾	20-750-PBAY-RHBB-1235	
Empty Bay, RH Bus Bar, 1625 A, continuous ⁽²⁾	20-750-PBAY-RHBB-1625	
Empty Bay, RH Bus Bar, 2437 A, continuous ⁽²⁾	20-750-PBAY-RHBB-2437	
Right Mount Bus Bar, Cable Connection, 2-Hole	20-750-PBAY-LBRK-2	
Right Mount Bus Bar, Cable Connection, 4-Hole	20-750-PBAY-LBRK-4	
Right Mount Bus Bar, Installation Kit, 3-Phase Connection ⁽²⁾	20-750-PBAY-INS-3	
Right Mount Bus Bar, Installation Kit, DC Connection ⁽²⁾	20-750-PBAY-INS-2	
Rear Drive Bus Bar, Cable Connection ⁽⁴⁾	20-750-PBAY-RBRK-2	

- (1) Contact your local Rockwell Automation sales office or Allen-Bradley distributor for availability.
- (2) Installed to the right of any PowerFlex 755 floor mount drive except a Frame 8 with disconnect (-P3 or -P5 option).
- (3) Only use with 600mm deep cabinet (drive enclosure code B).
- (4) Only use with a 800 mm deep cabinet (drive enclosure code J, K, L, P, W or Y).
- (5) Hardware kit includes door handle, door overlay label and Formex air barrier (installed between cabinets).



Approximate Dimensions and Weights (Frames 1...7)

Dimensions are in mm (in.) - weights are in kg (lb)

IP00/IP20, NEMA/UL Type Open

Frame	H	W	D	Weight
1	400.5 (15.77)	110 (4.33)	211 (8.31)	6 (12.75)
2	424.2 (16.7)	134.5 (5.3)	212 (8.35)	7.80 (17.2)
3	454 (17.87)	190 (7.48)		11.8 (26.1)
4	474 (18.66)	222 (8.74)		13.6 (30)
5	550 (21.65)	270 (10.63)		20.4 (45)
6	665.5 (26.2)	308 (12.13)	346.4 (13.64)	38.6 (85)
7	881.5 (34.7)	430 (16.93)	349.6 (13.76)	72.6...108.9 (160...240)

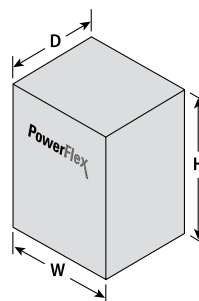

IP54, NEMA/UL Type 12

Frame	H	W	D	Weight ⁽¹⁾
2	543.2 (21.39)	215.3 (8.48)	222.2 (8.75)	8 (17)
3	551 (21.69)	268 (10.55)	220.1 (8.67)	12 (26)
4	571 (22.48)	300 (11.81)		14 (30)
5	647 (25.47)	348 (13.7)		20 (45)
6	1298.3 (51.11)	609.4 (24)	464.7 (18.3)	91 (200)
7	1614 (63.54)			162 (357)

(1) Weights are approximate. Refer to [750-TD001](#), the PowerFlex 750-Series Technical Data, for detailed weight information.

Flange Mount

Frame	H	W	D1	D2	Weight ⁽¹⁾
2	481.8 (18.97)	206.2 (8.12)	148.3 (5.84)	63.7 (2.51)	8 (17.0)
3	515 (20.28)	260 (10.24)	127.4 (5.02)	84.6 (3.33)	12 (26.0)
4	535 (21.06)	292 (11.50)			14 (30.0)
5	611 (24.06)	340 (13.39)			20 (45.0)
6	665.5 (26.20)	308 (12.13)	208.4 (8.20)	138 (5.43)	38 (84.0)
7	875 (34.45)	430.0 (16.93)			96 (212.0)

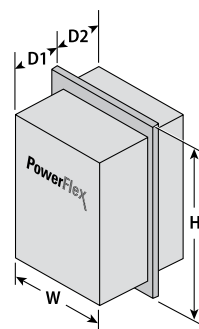

(1) Weights are approximate. Refer to [750-TD001](#), the PowerFlex 750-Series Technical Data, for detailed weight information.

Approximate Dimensions and Weights (Frames 8...10)

Dimensions are in mm (in.) - weights are in kg (lb)

IP20, NEMA/UL Type 1, MCC Style Cabinet

Frame	H	W	D	Weight
8	2453 (96.6)	600 (23.6)	600 (23.6) or 800 (31.5)	623 (1374)
8 with drive and option cabinets		1200 (47.2)		1145 (2525)
9		1800 (70.9)	800 (31.5)	2290 (5051)
9 with drive and option cabinets	600 (23.6) or 800 (31.5)			1869 (4122)
10	800 (31.5)		3435 (7576)	
10 with drive and option cabinets	2400 (94.5)	800 (31.5)		

IP54, NEMA Type 12, MCC Style Cabinet

Frame	H	W	D	Weight ⁽¹⁾
8	2477 (97.5)	600 (23.6)	800 (31.5) 898 (35.4) with filter	644 (1419)
8 with drive and option cabinets		1200 (47.2)		1166 (2570)
9		1800 (70.9)	800 (31.5)	1287 (2838)
9 with drive and option cabinets	600 (23.6) or 800 (31.5)			2332 (5141)
10	800 (31.5)		1931 (4257)	
10 with drive and option cabinets	2400 (94.5)	800 (31.5)	3498 (7711)	

(1) Weights are approximate. Refer to [750-ID001](#), the PowerFlex 750-Series Technical Data, for detailed weight information.

IP00, NEMA/UL Type Open⁽¹⁾

Frame	H	W	D
8	2145 (84.45)	778 (30.63)	425 (16.73)
9		1578 (62.12)	
10		2378 (93.62)	

(1) Refer to [750-ID001](#), the PowerFlex 750-Series Technical Data, for detailed information.

Maximum Component Weights, Frames 8...10

Component	AC Input	Common DC Input
Converter/DC input with precharge	64 (140)	64 (140)
Inverter	222 (490)	165 (363)
Drive assembly (Open, IP00)	286 (630)	229 (504)

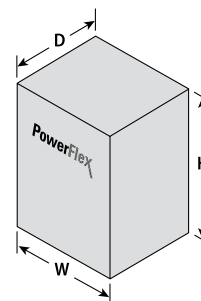

PowerFlex 755 Floor Mount Drives Power Wiring Options

The following table describes the cabling options available for each Frame 8...10 drive enclosure. Refer to the PowerFlex 750-Series Technical Data, publication [750-TD001](#) for conduit plate dimensions.

<div style="background-color: #cccccc; width: 20px; height: 10px; margin: 0 auto; margin-bottom: 5px;"></div> <p>Adequate Spacing Available conduit plates provide adequate spacing for typical cabling.</p>	<div style="background-color: #cccccc; width: 20px; height: 10px; margin: 0 auto; margin-bottom: 5px; display: flex; align-items: center; justify-content: center;">0</div> <p>Possible – Evaluation is Required Available conduit plates must be evaluated to determine if cabling can fit.⁽¹⁾</p>	<div style="background-color: #cccccc; width: 20px; height: 10px; margin: 0 auto; margin-bottom: 5px; display: flex; align-items: center; justify-content: center;">X</div> <p>Not Possible – Insufficient Spacing Conduit plates are not available for the specified configuration.</p>
---	---	---

Frame Size	Enclosure Rating	Enclosure Code	Cabinet Layout	Top Entry/ Top Exit	Top Entry/ Bottom Exit	Bottom Entry/ Top Exit	Bottom Entry/ Bottom Exit		
8	IP20, NEMA/UL Type 1	B	600 mm Drive Cabinet	X		X	0		
		L, P, W	800 mm Drive Cabinet	0		0			
		B	600 mm Drive with Power Option Bay			X	0		
		L, P, W	800 mm Drive with Power Option Bay			0			
		B	600 mm Drive with Wiring Bay						
		L, P, W	800 mm Drive with Wiring Bay						
		B	600 mm Drive with Power Option and Wiring Bays						
		L, P, W	800 mm Drive with Power Option Bay and Wiring Bays						
	IP54, NEMA 12	J, K, Y	800 mm Drive Cabinet		X		X	X	
			800 mm Drive with Power Option Bay					0	0
			800 mm Drive with Wiring Bay						
			800 mm Drive with Power Option Bay and Wiring Bays						
	9	IP20, NEMA/UL Type 1	B	600 mm Drive Cabinet	0		0	0	
L, P, W			800 mm Drive Cabinet						
B			600 mm Drive with Power Option Bay		X				
L, P, W			800 mm Drive with Power Option Bay		0				
B			600 mm Drive with Wiring Bay						
L, P, W			800 mm Drive with Wiring Bay						
B			600 mm Drive with Power Option and Wiring Bays						
L, P, W			800 mm Drive with Power Option Bay and Wiring Bays						
IP54, NEMA 12		J, K, Y	800 mm Drive Cabinet			X	X	X	
			800 mm Drive with Power Option Bay	0			0		
			800 mm Drive with Wiring Bay						
			800 mm Drive with Power Option Bay and Wiring Bays						

(table continues on next page)

PowerFlex 755 Floor Mount Drives Power Wiring Options (continued)

Frame Size	Enclosure Rating	Enclosure Code	Cabinet Layout	Top Entry/ Top Exit	Top Entry/ Bottom Exit	Bottom Entry/ Top Exit	Bottom Entry/ Bottom Exit	
10	IP20, NEMA/UL Type 1	B	600 mm Drive Cabinet	0		0	0	
		L, P, W	800 mm Drive Cabinet					
		B	600 mm Drive with Power Option Bay	X		X		
		L, P, W	800 mm Drive with Power Option Bay	0		0		
		B	600 mm Drive with Wiring Bay					
		L, P, W	800 mm Drive with Wiring Bay					
		B	600 mm Drive with Power Option and Wiring Bays					
		L, P, W	800 mm Drive with Power Option Bay and Wiring Bays					
	IP54, NEMA 12	J, K, Y	800 mm Drive Cabinet	X	X			
			800 mm Drive with Power Option Bay		0	0		
			800 mm Drive with Wiring Bay	0				
			800 mm Drive with Power Option Bay and Wiring Bays					

PowerFlex 755TL/TR AC Drives

160...2300 kW/250...3000 Hp in voltages from 400...690V

The new Allen-Bradley PowerFlex 755TL and 755TR drives expand the proven PowerFlex 753 and 755 AC drive portfolio and provide solutions for harmonic mitigation and regeneration. The drives offer energy-saving features and a world-class footprint along with simplified installation and start-up.

The new PowerFlex drives use TotalFORCE technology to deliver exceptional motor control through precise, adaptive control of position, velocity and torque. TotalFORCE technology incorporates several patented features that are designed to help optimize your system and maintain productivity through improved machine uptime.

PowerFlex 755TL and 755TR at a Glance

Ratings	755TL	755TR
400V	160...1250 kW	160...2000 kW
480V	250...1800 Hp	250...3000 Hp
600V	250...1500 Hp	250...2500 Hp
690V	200...1400 kW	200...2300 kW
Motor Control	<ul style="list-style-type: none"> Field Oriented Control Sensorless Vector Control Flux Vector Control 	<ul style="list-style-type: none"> V/Hz Control Economizer
Enclosures	<ul style="list-style-type: none"> IP21, UL Type 1 	<ul style="list-style-type: none"> IP54, UL Type 12
Safety Options	<ul style="list-style-type: none"> Hardwired Safe Torque Off SIL3, PLe, CAT 3 Hardwired Safe Speed Monitor SIL3, PLe, CAT 4 	<ul style="list-style-type: none"> Networked Safe Torque Off SIL3, PLe, CAT 3
Additional Features	<ul style="list-style-type: none"> Active front end ride-through control reduces downtime TotalFORCE Technology Energy-efficient regenerative capability Provides harmonic mitigation and power factor correction Optional built-in Dv/Dt filter designed to mitigate reflective wave phenomenon 	<ul style="list-style-type: none"> Modular construction for easy install and maintenance Built-in dual port EtherNet/IP Predictive diagnostics help monitor drive components
Certifications	<ul style="list-style-type: none"> ABS AC156 Seismic Standards ATEX CAN/CSA CE Mark DNV EAC Mark IEC60721-3-3 	<ul style="list-style-type: none"> ISA 71.04-1985 KCC Lloyd's Register ODVA EtherNet/IP RCM SEMI F47 UkrSepro Mark UL61800-5-1 (cULus)
Options	See page 124	

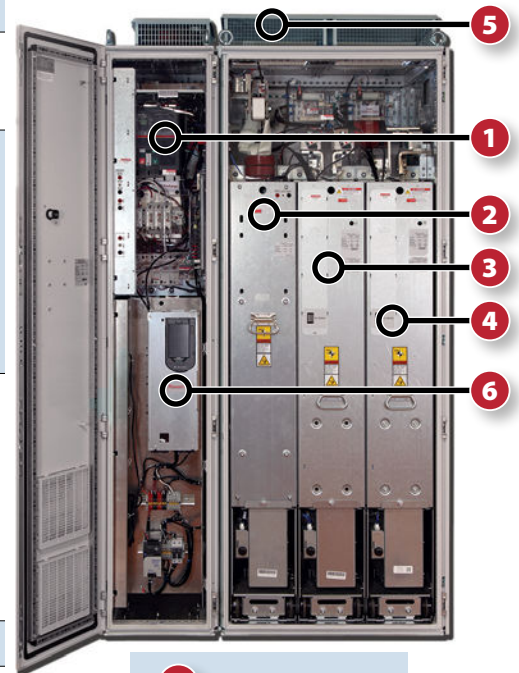

- 1** AC Pre-charge
- 2** LCL Filter
- 3** Line Side Converter
- 4** Motor Side Inverter
- 5** IP21/IP54 Enclosures
- 6** Control Pod

PowerFlex 755TL AC Drive

The PowerFlex 755TL drive provides harmonic mitigation and power factor correction through the use of active front end technology. By reducing the adverse effects of harmonic distortion, the drive helps to improve energy efficiency, reduce energy costs and minimize power distribution issues on the factory floor. In addition, new TotalFORCE technology delivers exceptional motor control through precise, adaptive control of velocity, torque and position with patented features designed to help optimize your system and maintain productivity.

PowerFlex 755TR AC Drive

The PowerFlex 755TR drive has built-in regeneration capability that helps reduce energy consumption by delivering regenerative energy from motors back to the incoming supply. Line regeneration can reduce the need for braking resistors and associated cooling equipment and helps avoid wasteful dissipation of energy. The drive also offers harmonic mitigation and the benefits of TotalFORCE technology as well as a world-class footprint and simplified startup and installation.

Additional Information

PowerFlex 755T Drive Solutions Brochure, publication [755T-BR001](#)

PowerFlex 750-Series Products with TotalFORCE Control Technical Data, publication [750-TD100](#)

Catalog Number Explanation

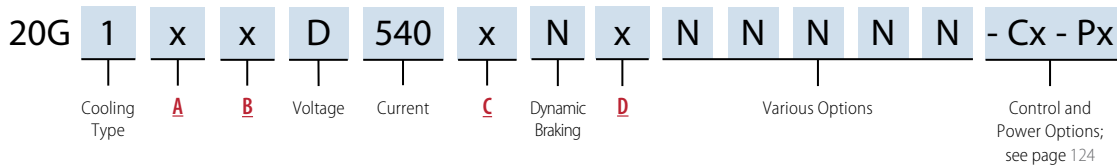

A

Input Type	
Code	Description
F	Regenerative and low harmonic AFE
G	Low harmonic AFE ⁽¹⁾

⁽¹⁾ Low harmonic AFE (755TL) is only available up to 1800 Hp/1342 kW.

B

Enclosure	
Code	Description
3	IP21, UL Type 1; floor mount
4	IP54, UL Type 12; floor mount

C

Filtering and CM Cap Configuration			
Code	EMC Filtering	CM Cap Default Configuration	Reflected Wave Filtering
J	Yes	Jumper Installed	No
K	Yes	Jumper Installed	Yes
L	No	Jumper Installed	No
M	No	Jumper Installed	Yes

D

Door Mounted HIM	
Code	Operator Interface and Control
A	No door mounted HIM with TotalFORCE control
D	Enhanced LCD, full numeric, IP66, NEMA Type 4X/12 with TotalFORCE control

Product Selection

400V AC, Three-phase Drives

IP21/IP54, UL Types 1/12

Light Duty			Normal Duty					Heavy Duty					Base Cat. No.	Frame Size	
kW	Cont.	1 min	kW	Cont.	1 min	3 s	Hp	kW	Cont.	1 min	3 s	Hp			
200	367	404	160	302	332	453	200	132	260	390	468	200	20G1xxC302xNxNNNNN-Cx-Px	8 ⁽¹⁾	
250	460	506	200	367	404	551	250	160	302	453	544	250	20G1xxC367xNxNNNNN-Cx-Px		
315	540	594	250	460	506	690	300	200	367	551	661	300	20G1xxC460xNxNNNNN-Cx-Px		
	585	644	315	540	594	810	350	250	460	690	828	350	20G1xxC540xNxNNNNN-Cx-Px		
355	650	715	315	585	644	878	350	250	472	708	850	350	20G1xxC585xNxNNNNN-Cx-Px		
400	750	825	355	650	715	975	400	315	540	810	972	400	20G1xxC650xNxNNNNN-Cx-Px		
450	796	876	400	750	825	1125	450	315	585	878	1053	450	20G1xxC750xNxNNNNN-Cx-Px		
	832	915	400	770	847	1155	500	355	650	975	1170	500	20G1xxC770xNxNNNNN-Cx-Px		
560	1040	1144	500	920	1012	1380	600	400	770	1155	1386	600	20G1xxC920xNxNNNNN-Cx-Px		9 ⁽¹⁾
630	1090	1199	560	1040	1144	1560	700	500	920	1380	1656	700	20G1xxC1K0xNxNNNNN-Cx-Px		
710	1182	1300	630	1112	1223	1668	750	500	1040	1560	1872	750	20G1xxC1K1xNxNNNNN-Cx-Px		
800	1465	1612	710	1175	1293	1763	800	560	1090	1635	1962	800	20G1xxC1K2xNxNNNNN-Cx-Px		
850	1581	1739	800	1465	1612	2198	900	630	1175	1763	2115	900	20G1xxC1K4xNxNNNNN-Cx-Px		
1000	1715	1887	850	1590	1749	2385	1000	710	1465	2198	2637	1000	20G1xxC1K6xNxNNNNN-Cx-Px	10 ⁽¹⁾	
1250	2150	2365	1000	1715	1887	2573	1100	800	1480	2220	2664	1100	20G1xxC1K7xNxNNNNN-Cx-Px		
1400	2330	2563	1250	2156	2372	3234	1500	1000	1715	2573	3087	1500	20G1xxC2K1xNxNNNNN-Cx-Px		
1800	3078	3386	1650	2849	3134	4274	2000	1400	2330	3495	4194	2000	20G1xxC2K8xNxNNNNN-Cx-Px	11	
2200	3846	4231	2000	3542	3896	5313	2400	1650	3032	4548	5458	2400	20G1xxC3K5xNxNNNNN-Cx-Px	12	

(1) Low harmonic AFE (755TL) is only available in frame sizes 8, 9, and 10.

480V AC, Three-phase Drives

IP21/IP54, UL Types 1/12

Light Duty				Normal Duty					Heavy Duty					Base Cat. No.	Frame Size
kW	Cont.	1 min	Hp	kW	Cont.	1 min	3 s	Hp	kW	Cont.	1 min	3 s	Hp		
200	361	397	300	186	302	332	453	250	149	248	372	446	200	20G1xxD302xNxNNNNN-Cx-Px	8 ⁽¹⁾
250	430	473	350	224	361	397	542	300	186	302	453	544	250	20G1xxD361xNxNNNNN-Cx-Px	
315	485	534	400	261	430	473	645	350	224	361	542	650	300	20G1xxD430xNxNNNNN-Cx-Px	9 ⁽¹⁾
	545	600	450	298	505	556	758	400	261	430	645	774	350	20G1xxD505xNxNNNNN-Cx-Px	
355	617	679	500	336	545	600	818	450	261	454	681	817	350	20G1xxD545xNxNNNNN-Cx-Px	10 ⁽¹⁾
400	710	781	600	373	617	679	926	500	298	485	728	873	400	20G1xxD617xNxNNNNN-Cx-Px	
450	765	842	650	447	710	781	1065	600	336	545	818	981	450	20G1xxD710xNxNNNNN-Cx-Px	11
	800	880	700	485	740	814	1110	650	373	617	926	1111	500	20G1xxD740xNxNNNNN-Cx-Px	
560	960	1056	800	522	800	880	1200	700	447	740	1110	1332	600	20G1xxD800xNxNNNNN-Cx-Px	12
630	1045	1150	900	597	960	1056	1440	800	522	800	1200	1440	700	20G1xxD960xNxNNNNN-Cx-Px	
710	1135	1249	1000	671	1045	1150	1568	900	559	960	1440	1728	750	20G1xxD1K0xNxNNNNN-Cx-Px	11
800	1365	1502	1100	746	1135	1249	1703	1000	597	1045	1568	1881	800	20G1xxD1K1xNxNNNNN-Cx-Px	
850	1520	1672	1250	820	1365	1502	2048	1100	671	1135	1703	2043	900	20G1xxD1K3xNxNNNNN-Cx-Px	10 ⁽¹⁾
1000	1655	1821	1500	932	1420	1562	2130	1250	746	1365	2048	2457	1000	20G1xxD1K4xNxNNNNN-Cx-Px	
1250	2070	2277	1800	1119	1655	1821	2483	1500	820	1420	2130	2556	1100	20G1xxD1K6xNxNNNNN-Cx-Px	11
1400	2240	2464	2000	1342	2072	2279	3108	1800	1119	1655	2483	2979	1500	20G1xxD2K0xNxNNNNN-Cx-Px	
1800	2960	3256	2600	1790	2738	3012	4107	2400	1491	2240	3360	4032	2000	20G1xxD2K6xNxNNNNN-Cx-Px	12
2200	3696	4066	3300	2237	3404	3744	5106	3000	1790	2980	4470	5364	2400	20G1xxD3K4xNxNNNNN-Cx-Px	

(1) Low harmonic AFE (755TL) is only available in frame sizes 8, 9, and 10.

600V AC, Three-phase Drives

IP21/IP54, UL Types 1/12

Light Duty				Normal Duty					Heavy Duty					Base Cat. No.	Frame Size
kW	Cont.	1 min	Hp	kW	Cont.	1 min	3 s	Hp	kW	Cont.	1 min	3 s	Hp		
224	295	325	300	186	242	266	363	250	149	192	288	346	200	20G1xxE242xNxNNNNN-Cx-Px	8 ⁽¹⁾
261	355	391	350	224	295	325	443	300	186	242	363	436	250	20G1xxE295xNxNNNNN-Cx-Px	
298	395	435	400	261	355	391	533	350	224	295	443	531	300	20G1xxE355xNxNNNNN-Cx-Px	
336	435	479	450	298	395	435	593	400	261	355	533	639	350	20G1xxE395xNxNNNNN-Cx-Px	
373	510	561	500	336	435	479	653	450	298	395	593	711	400	20G1xxE435xNxNNNNN-Cx-Px	
447	580	638	600	410	545	600	818	550	335	450	675	810	450	20G1xxE545xNxNNNNN-Cx-Px	
522	690	759	700	447	580	638	870	600	410	545	818	981	550	20G1xxE595xNxNNNNN-Cx-Px	9 ⁽¹⁾
597	760	836	800	485	690	759	1035	700	373	595	893	1071	600	20G1xxE690xNxNNNNN-Cx-Px	
671	825	908	900	597	760	836	1140	800	522	690	1035	1242	700	20G1xxE760xNxNNNNN-Cx-Px	
746	980	1078	1000	671	825	908	1238	900	597	760	1140	1368	800	20G1xxE825xNxNNNNN-Cx-Px	
820	1102	1212	1100	746	980	1078	1470	1000	671	825	1238	1485	900	20G1xxE980xNxNNNNN-Cx-Px	
932	1220	1342	1250	820	1045	1150	1568	1100	746	980	1470	1764	1000	20G1xxE1K1xNxNNNNN-Cx-Px	10 ⁽¹⁾
1119	1430	1573	1500	932	1220	1342	1830	1250	820	1045	1568	1881	1100	20G1xxE1K2xNxNNNNN-Cx-Px	
1193	1624	1786	1600	1119	1430	1573	2145	1500	932	1220	1830	2196	1250	20G1xxE1K5xNxNNNNN-Cx-Px	
1566	2146	2361	2100	1491	1946	2141	2919	2000	1342	1700	2550	3060	1800	20G1xxE2K0xNxNNNNN-Cx-Px	11
1939	2668	2935	2600	1864	2420	2662	3630	2500	1566	2070	3105	3726	2100	20G1xxE2K4xNxNNNNN-Cx-Px	12

(1) Low harmonic AFE (755TL) is only available in frame sizes 8, 9, and 10.

690V AC, Three-phase Drives

IP21/IP54, UL Types 1/12

Light Duty				Normal Duty					Heavy Duty					Base Cat. No.	Frame Size
kW	Cont.	1 min	Hp	kW	Cont.	1 min	3 s	Hp	kW	Cont.	1 min	3 s	Hp		
250	265	292	335	200	215	237	323	268	160	171	257	308	215	20G1xxF215xNxNNNNN-Cx-Px	8 ⁽¹⁾
315	330	363	422	250	265	292	398	335	200	215	323	387	268	20G1xxF265xNxNNNNN-Cx-Px	
355	370	407	476	315	330	363	495	422	250	265	398	477	335	20G1xxF330xNxNNNNN-Cx-Px	
400	415	457	536	355	370	407	555	476	315	330	495	594	422	20G1xxF370xNxNNNNN-Cx-Px	
450	460	506	603	400	415	457	623	536	355	370	555	666	476	20G1xxF415xNxNNNNN-Cx-Px	
560	565	622	751	500	505	556	758	671	400	415	623	747	536	20G1xxF505xNxNNNNN-Cx-Px	
630	650	715	845	560	565	622	848	751	500	505	758	909	671	20G1xxF565xNxNNNNN-Cx-Px	9 ⁽¹⁾
710	735	809	952	630	650	715	975	845	560	565	848	1017	751	20G1xxF650xNxNNNNN-Cx-Px	
800	820	902	1073	710	735	809	1103	952	630	650	975	1170	845	20G1xxF735xNxNNNNN-Cx-Px	
900	920	1012	1207	800	820	902	1230	1073	710	735	1103	1323	952	20G1xxF820xNxNNNNN-Cx-Px	
1000	1074	1181	1341	900	920	1012	1380	1207	800	820	1230	1476	1073	20G1xxF920xNxNNNNN-Cx-Px	
1100	1150	1265	1475	1000	1030	1133	1545	1341	900	920	1380	1656	1207	20G1xxF1K0xNxNNNNN-Cx-Px	10 ⁽¹⁾
1250	1344	1478	1676	1100	1150	1265	1725	1475	1000	1030	1545	1854	1341	20G1xxF1K1xNxNNNNN-Cx-Px	
1500	1582	1740	2012	1400	1419	1561	2129	1877	1100	1162	1743	2092	1475	20G1xxF1K4xNxNNNNN-Cx-Px	
2000	2091	2300	2682	1800	1865	2052	2798	2414	1500	1535	2303	2763	2012	20G1xxF1K8xNxNNNNN-Cx-Px	11
2500	2599	2859	3353	2300	2318	2550	3477	3084	2000	2020	3030	3636	2682	20G1xxF2K3xNxNNNNN-Cx-Px	12

(1) Low harmonic AFE (755TL) is only available in frame sizes 8, 9, and 10.

Control and Power Options for PowerFlex 755TL and TR Drives

Pre-engineered, factory installed options are available with the PowerFlex 755TL and 755TR drives.

To configure a catalog number for a PowerFlex 755T drive with options, perform the following steps:

2. Select the base drive catalog number from the tables on the previous pages. Drive selection is based on the output amps and corresponding system overload(s) required by the application.
For example: 20G1xxC750xNxNNNNN-Cx-Px.
3. Select required control from the Control and Power Options table. For example: 20G1xxC750xNxNNNNN-**C0**-Px.
4. Select required power from the table. Add the desired option codes to the end of the base drive catalog number, separating each option code with a dash. For example: 20G1xxC750xNxNNNNN-**C0-P15**.
5. If needed, select other power options from the table. For example: 20G1xxC750xNxNNNNN-**C0-P15-P46**.

Control and Power Options

Type	Option	Frame Sizes	Description
Control Options	C0 Torque Accuracy Control	8...12	Option that enables increased torque performance capability and the ability to operate in a Field Oriented Control mode.
Power Options	P15 Top Cable Exit (with wiring bay)	8...12	Option that enables a user to bring in their motor cables from the top of the cabinet.
	P16 Top Cable Entry (with wiring bay)	10...12	Option that enables a user to bring in their power/input cables from the top of the cabinet.
	P17 Top Cable Exit (without wiring bay)	8...9	Option that enables a user to bring in their power/input cables from the top of the cabinet.
	P50 DC Bus Conditioner	8...12	Eliminates peak voltage spikes on the system DC bus. Intended for systems that are not solidly grounded.

Approximate Dimensions and Weights (Frames 8...12)

Dimensions are in mm (in.) - weights are in kg (lb)

PowerFlex 755TL Drives

Input Voltage	Normal Duty Rating	Width	Combined Width - Drive with Optional Wiring Bays			Depth		Height		Weight	
		Drive	With Entry Bay	With Exit Bay	With Both Bays	IP21	IP54	IP21	IP54	Without Filter	With Filter
400	160...400 kW	1200 (47.2)	(1)	1600 (63)	(1)	675 (26.6)	720 (28.3)	2132 (83.9)	2291 (90.2)	861.8 (1900)	920.8 (2030)
480	250...650 Hp										
600	250...550 Hp										
690	200...500 kW										
400	400...800 kW	2000 (78.7)	(1)	2400 (94.5)	(1)	675 (26.6)	720 (28.3)	2132 (83.9)	2291 (90.2)	1360.8 (3000)	1419.7 (3130)
480	650...1100 Hp										
600	550...1000 Hp										
690	500...900 kW										
400	800...1250 kW	3200 (126)	3600 (141.7)	3600 (141.7)	4000 (157.5)	675 (26.6)	720 (28.3)	2132 (83.9)	2291 (90.2)	2925.7 (6450)	3043.6 (6710)
480	1100...1800 Hp										
600	1000...1500 Hp										
690	900...1400 kW										

(1) Optional wiring bay is not required for top entry of power cables.

PowerFlex 755TR Drives

Input Voltage	Normal Duty Rating	Width	Combined Width - Drive with Optional Wiring Bays			Depth		Height		Weight	
		Drive	With Entry Bay	With Exit Bay	With Both Bays	IP21	IP54	IP21	IP54	Without Filter	With Filter
400	160...400 kW	1200 (47.2)	(1)	1600 (63)	(1)	675 (26.6)	720 (28.3)	2132 (83.9)	2291 (90.2)	861.8 (1900)	920.8 (2030)
480	250...650 Hp										
600	250...550 Hp										
690	200...500 kW										
400	400...800 kW	2000 (78.7)	(1)	2400 (94.5)	(1)	675 (26.6)	720 (28.3)	2132 (83.9)	2291 (90.2)	1360.8 (3000)	1419.7 (3130)
480	650...1100 Hp										
600	550...1000 Hp										
690	500...900 kW										
400	800...1250 kW	3200 (126)	3600 (141.7)	3600 (141.7)	4000 (157.5)	675 (26.6)	720 (28.3)	2132 (83.9)	2291 (90.2)	2925.7 (6450)	3043.6 (6710)
480	1100...1800 Hp										
600	1000...1500 Hp										
690	900...1400 kW										
400	1200...1650 kW	3800 (149.6)	4600 (181.1)	4600 (181.1)	5400 (212.6)	675 (26.6)	720 (28.3)	2132 (83.9)	2291 (90.2)	3447.3 (7600)	3565.2 (7860)
480	1800...2400 Hp										
600	1500...2000 Hp										
690	1400...1800 kW										
400	1650...2000 kW	4600 (181.1)	5400 (212.6)	5400 (212.6)	6200 (244.1)	675 (26.6)	720 (28.3)	2132 (83.9)	2291 (90.2)	4286 (9450)	4463.3 (9840)
480	2400...3000 Hp										
600	2000...2500 Hp										
690	1800...2300 kW										

(1) Optional wiring bay is not required for top entry of power cables.

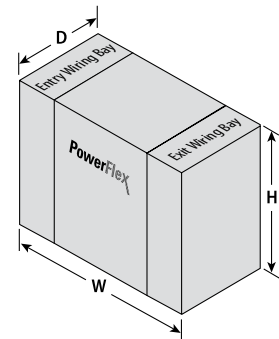

PowerFlex 7-class Options

Human Interface Modules



Description	Cat. No.	Used with PowerFlex Drive		
		70	753/755	755TL/755TR
No HIM (Blank Plate), Handheld/Local (Drive Mount)	20-HIM-A0	✓	✓	✓
LCD Display, Full Numeric Keypad, Handheld/Local (Drive Mount)	20-HIM-A3	✓	—	—
LCD Display, Programmer Only, Handheld/Local (Drive Mount)	20-HIM-A5	✓	—	—
Enhanced, LCD, Full Numeric Keypad, Handheld/Local (Drive Mount)	20-HIM-A6	✓	✓	✓
Remote (Panel Mount) LCD Display, Full Numeric Keypad ⁽¹⁾⁽²⁾	20-HIM-C3S	✓	—	—
Remote (Panel Mount) LCD Display, Programmer Only ⁽¹⁾⁽²⁾	20-HIM-C5S	✓	—	—
Enhanced, LCD, Full Numeric Keypad ⁽¹⁾⁽²⁾	20-HIM-C6S	✓	✓	✓

(1) IP66, NEMA Type 4X/12—only for indoor use.

(2) Includes a 1202-C30 interface cable (3 m/9.8 ft) for connection to drive.

Human Interface Module (HIM) Accessories

Description	Cat. No.	Used with PowerFlex Drive			
		70	753/755	755TL/755TR	DC
Bezel Kit for LCD HIMs, NEMA Type 1 ⁽¹⁾	20-HIM-B1	✓	✓	✓	✓
PowerFlex HIM Interface Cable, 1 m (3.3 ft) ⁽²⁾	20-HIM-H10	✓	✓	✓	✓
Comm Option Cable Kit (Male-Male)					
0.33 m (1.1 ft)	1202-C03	✓	✓	✓	✓
1 m (3.3 ft)	1202-C10	✓	✓	✓	✓
3 m (9.8 ft)	1202-C30	✓	✓	✓	✓
9 m (29.5 ft)	1202-C90	✓	✓	✓	✓
Cable Kit (Male-Female) ⁽³⁾					
0.33 m (1.1 ft)	1202-H03	✓	✓	✓	✓
1 m (3.3 ft)	1202-H10	✓	✓	✓	✓
3 m (9.8 ft)	1202-H30	✓	✓	✓	✓
9 m (29.5 ft)	1202-H90	✓	✓	✓	✓
DPI™ Cable Kit with Connectors, Tools and 100 m (328 ft) Cable	1202-CBL-KIT-100M	✓	✓	✓	✓
DPI Cable Connector Kit	1202-TB-KIT-SET	✓	✓	✓	✓
DPI/SCANport™ One to Two Port Splitter Cable	1203-S03	✓	✓	✓	✓

(1) Includes a 1202-C30 interface cable (3 m/9.8 ft) for connection to drive.

(2) Required only when HIM is used as handheld or remote.

(3) Required in addition to 20-HIM-H10 for distances up to a total maximum of 10 m (32.8 ft).

Communication Option Kits

Description	Cat. No.	Used with PowerFlex Drive			
		70	753/755	755TL/755TR	DC
BACnet/IP Option Module	20-750-BNETIP	—	✓	—	—
BACnet® MS/TP RS485 Communication Adapter	20-COMM-B	✓	—	—	✓
Coaxial ControlNet™ Option Module	20-750-CNETC	—	✓	✓	—
ControlNet™ Communication Adapter (Coax)	20-COMM-C	✓	✓ ⁽¹⁾	—	✓
DeviceNet™ Option Module	20-750-DNET	—	✓	✓	—
DeviceNet™ Communication Adapter	20-COMM-D	✓	✓ ⁽¹⁾	—	✓
Dual-port EtherNet/IP Option Module	20-750-ENETR	—	✓	✓	—
EtherNet/IP™ Communication Adapter	20-COMM-E	✓	✓ ⁽¹⁾	—	✓
Dual-port EtherNet/IP™ Communication Adapter	20-COMM-ER	✓	—	—	✓
HVAC Communication Adapter	20-COMM-H	✓	✓ ⁽¹⁾	—	✓
CANopen® Communication Adapter	20-COMM-K	✓	✓ ⁽¹⁾	—	✓
LonWorks® Communication Adapter	20-COMM-L	✓	✓ ⁽¹⁾	—	✓
Modbus/TCP Communication Adapter	20-COMM-M	✓	✓ ⁽¹⁾	—	✓
Profibus DPV1 Option Module	20-750-PBUS	—	✓	✓	—
Single-port Profinet I/O Option Module	20-750-PNET	—	✓	✓	—
Dual-port Profinet I/O Option Module	20-750-PNET2P	—	✓	✓	—
PROFIBUS™ DP Communication Adapter	20-COMM-P	✓	✓ ⁽¹⁾	—	✓
ControlNet™ Communication Adapter (Fiber)	20-COMM-Q	✓	✓ ⁽¹⁾	—	✓
RS485 DF1 Communication Adapter	20-COMM-S	✓	✓ ⁽¹⁾	—	✓
External Communications Kit Power Supply	20-XCOMM-AC-PS1	✓	✓	—	✓
DPI External Communications Kit	20-XCOMM-DC-BASE	✓	✓	—	✓
External DPI I/O Option Board ⁽²⁾	20-XCOMM-IO-OPT1	✓	✓	—	✓
Compact I/O Module (3 Channel)	1769-SM1	✓	✓	—	✓

(1) Requires a Communication Carrier Card (20-750-20COMM or 20-750-20COMM-F1). Refer to the Communication Accessories table on page 128 for details.

(2) For use only with DPI External Communications Kits 20-XCOMM-DC-BASE.

PowerFlex 750-Series Legacy Communication Compatibility

Most legacy communication adapters (20-COMM) can be used with the PowerFlex 753/755. However, the restrictions stated below do apply.

Frame 1 - It is recommended that the 20-750-20COMM-F1 Communication Carrier Card only be installed in Port 4. Port 5 is not accessible when this module is installed.

Frames 2 and larger - It is recommended that the 20-750-20COMM Communication Carrier Card be installed in Port 6. By using Port 4 or 5, the adjacent left port becomes inaccessible to other option modules and it can interfere with network cable connections.

Adapter		Accesses Ports 0...6 for I/O Connections (Implicit and Explicit Messaging)	Accesses Ports 7 and Higher (I/O, Explicit Messaging)	Supports Drive Add-on Profiles	Supports Asian-Languages ⁽²⁾
Cat. No.	Type				
20-COMM-B	BACnet MS/TP	Not Compatible			
20-COMM-C	ControlNet (Coax)	✓ v3.001 ⁽²⁾	✓ v3.001 ⁽²⁾	✓ ⁽³⁾	✓ v3.001 ⁽²⁾
20-COMM-D	DeviceNet	✓ ⁽⁴⁾	Not Compatible		
20-COMM-E	EtherNet/IP	✓ v4.001 ⁽⁴⁾	✓ v4.001 ⁽²⁾	✓ ⁽³⁾	✓ v4.001 ⁽²⁾
20-COMM-H	RS-485 HVAC	✓ v2.009 ⁽²⁾⁽⁵⁾	Not Compatible		
20-COMM-K	CANopen	✓ v1.001 ⁽²⁾			
20-COMM-L	LonWorks	✓ v1.007 ⁽²⁾			
20-COMM-M	Modbus/TCP	✓ v2.001 ⁽²⁾	✓ v2.001 ⁽²⁾	Not Compatible	✓ v2.001 ⁽²⁾
20-COMM-P	ControlNet (Fiber)	✓ v1.006 ⁽²⁾	✓ v1.006 ⁽²⁾		Not Compatible
20-COMM-Q	PROFIBUS DP	✓ v3.001 ⁽²⁾	✓ v3.001 ⁽²⁾	✓ ⁽³⁾	✓ v3.001 ⁽²⁾
20-COMM-S	RS-485 DF1	✓ ⁽⁴⁾	Not Compatible		

- (1) Chinese, Japanese, and Korean languages are supported at the time of publication.
- (2) Requires this adapter firmware version or higher.
- (3) Requires firmware version v1.05 or higher of the drive Add-on Profiles for Studio 5000 Logix Designer software.
- (4) Controller must be capable of reading/writing 32-bit floating point (REAL) values.
- (5) Supports all three modes of operation (RTU, P1, N2).

Communication Accessories

Description	Cat. No.	Used with PowerFlex Drive		
		70	753/755	755TL/TR
Universal Serial Bus™ (USB) Converter includes 2m USB, 20-HIM-H10 and 22-HIM-H10 Cables	1203-USB	✓	✓	✓
ControlNet T-tap Straight	1786-TPS	—	✓	—
Communication Carrier Card for PowerFlex 750-Series Frame 1 drives	20-750-20COMM-F1		✓	
Communication Carrier Card for PowerFlex 750-Series Frame 2 or higher drives	20-750-20COMM		✓	

I/O Option Kits

Description	Cat. No.	Used with PowerFlex Drive	
		753/755	755TL/755TR
ATEX Option Module with 1 Thermosensor Input Connection (requires 11-Series I/O Module below)	20-750-ATEX	✓ ⁽¹⁾	✓
24V DC 11-Series I/O Module with 1 Analog In, 1 Analog Out, 3 Digital In and 2 Relay Outputs	20-750-1132C-2R	✓ ⁽¹⁾	✓
24V DC 11-Series I/O Module with 1 Analog In, 1 Analog Out, 3 Digital In, 1 Relay and 2 Transistor Outputs	20-750-1133C-1R2T	✓ ⁽¹⁾	✓
115V AC 11-Series I/O Module with 1 Analog In, 1 Analog Out, 3 Digital In and 2 Relay Outputs	20-750-1132D-2R	✓ ⁽¹⁾	✓
24V DC 22-Series I/O Module with 2 Analog In, 2 Analog Out, 6 Digital In and 2 Relay Outputs	20-750-2262C-2R	✓ ⁽¹⁾	✓
115V AC 22-Series I/O Module with 2 Analog In, 2 Analog Out, 6 Digital In and 2 Relay Outputs	20-750-2262D-2R	✓ ⁽¹⁾	✓
24V DC 22-Series I/O Module with 2 Analog In, 2 Analog Out, 6 Digital In, 3 Digital Out, 1 Relay and 2 Transistor Outputs	20-750-2263C-1R2T	✓ ⁽¹⁾	✓

(1) For kits to be used with CIP Motion instructions, the card can only be used in slot 7 of the PowerFlex 755 drive. It also requires PowerFlex 755 firmware version 12 and higher, and Studio 5000 version 28 and higher.

Safety Options⁽¹⁾

Description	Cat. No.	Used with PowerFlex Drive			
		70	753	755	755TL/755TR
DriveGuard Safe Torque Off	20A-DG01	✓	—	—	—
Hardwired Safe Torque Off	20-750-S	—	✓	✓	✓
Hardwired Safe Speed Monitor	20-750-S1	—	✓ ⁽²⁾	✓ ⁽²⁾	✓
Networked Safe Torque Off	20-750-S3	—	—	✓ ⁽³⁾⁽⁴⁾	✓ ⁽³⁾

(1) All PowerFlex 7-series drives can accommodate only one safety option.

(2) Requires the Dual Incremental Encoder or Universal Feedback Option. Also requires the 20-750-EMCSSM1-F8 EMC Option Kit with Frame 8...9 drives.

(3) Requires Studio 5000 version 30 and higher.

(4) Requires PowerFlex 755 firmware version 13 and higher. This option is not allowed while controlling a PowerFlex drive in CIP Motion mode.

Feedback Options

Description	Cat. No.	Used with PowerFlex Drive		
		70	753/755	755TL/755TR
5V/12V Encoder ⁽¹⁾	20A-ENC-1	✓	—	—
Incremental Encoder	20-750-ENC-1	—	✓ ⁽²⁾	✓
Dual Incremental Encoder	20-750-DENC-1	—	✓ ⁽²⁾	✓
Universal Feedback (includes Stegmann, Heidenhain, SSI, Biss, 5V Incremental)	20-750-UFB-1	—	✓ ⁽³⁾	✓

(1) Works only with PowerFlex 70 Enhanced Control.

(2) Homing and registration functions are not supported when using this device with Studio 5000 Logix Designer embedded motion instructions. To use these functions, the Universal Feedback Board (20-750-UFB-1) must be used.

(3) Only for PowerFlex 755 drives.

Other Options

Description	Cat. No.	Used with PowerFlex Drive		
		70	753/755	755TL/755TR
115V AC Interface	AK-M9-115VAC-1	✓	—	—
Frame E Flange Gasket	AK-M9-GASKET1-E4	✓	—	—
Service Connection Board ⁽¹⁾	SK-M9-SCB1	✓	—	—

(1) Provides temporary DPI/HIM connection for NEMA/UL Type 1 and Flange drives with cover removed.

PowerFlex 750-Series Option Kits

Description	Frame Size	Cat. No.	Used with PowerFlex Drive		
			753	755	
Auxiliary Power Supply	24V Aux Power Supply	1...7 ⁽¹⁾	20-750-APS	✓	✓
DC Bus Bar Option Kit	DC Bus Bars for 380...480V AC drives	6	20-750-DCBB1-F6	✓	✓
		7	20-750-DCBB1-F7	✓	✓
	DC Bus Bars for 600...690V AC drives	6	20-750-DCBB2-F6	✓	✓
		7	20-750-DCBB2-F7	✓	✓
DC Bus Connection Kit	Connects the drive DC bus terminals to the cabinet bus rails.	8	20-750-BUS1A-F8	✓	✓
EMC Option Kit	EMC Plate with Core for 380...480V AC drives	1	20-750-EMC1-F1	✓	✓
		2	20-750-EMC1-F2	✓	✓
		3	20-750-EMC1-F3	✓	✓
	EMC Plate with Core for 600V AC drives		20-750-EMC3-F3	✓	✓
	EMC Plate with Cores for 380...480V AC drives	4	20-750-EMC1-F4	✓	✓
		5	20-750-EMC1-F5	✓	✓
	EMC Plate with Cores for 600V AC drives	4	20-750-EMC3-F4	✓	✓
		5	20-750-EMC3-F5	✓	✓
	EMC Core for 380...480V AC drives	1	20-750-EMC2-F1	✓	✓
		2	20-750-EMC2-F2	✓	✓
		3	20-750-EMC2-F3	✓	✓
	EMC Core for 600V AC drives		20-750-EMC4-F3	✓	✓
	EMC Cores for 380...480V AC drives	4...5	20-750-EMC2-F45	✓	✓
	EMC Cores for 600V AC drives	4	20-750-EMC4-F4	✓	✓
		5	20-750-EMC4-F5	✓	✓
	EMC Plate with Cores for 600...690V AC drives	6	20-750-EMC3-F6	✓	✓
		7	20-750-EMC3-F7	✓	✓
	EMC Plate with Cores for 600...690V AC drives (IP54 Only)	6	20-750-EMC5-F6	✓	✓
		7	20-750-EMC5-F7	✓	✓
	EMC Core – Inverter-mounted output cores, for 380...690V AC input and DC input drives. One each for Frame 8, two each for Frame 9, and three each for Frame 10.	8...10	20-750-EMCCM1-F8	—	✓
EMC Cores – Required when using the Safe Speed Monitor option 20-750-S1 with 380...690V drives.	20-750-EMCSSM1-F8			✓	
Door Shielding Kit	20-750-EMCDK1-F10			✓	
Exhaust Hood	Exhaust Hood – IP20, NEMA/UL Type 1 drives. ⁽²⁾	8...10	20-750-HOOD1-F8		✓

(1) Frame 8 and up drives can be powered from an external 24V DC source, a 20-750-APS is not required.

(2) Exhaust hood is standard on Frames 8...10, IP54-rated cabinets.

(table continues on next page)

PowerFlex 750-Series Option Kits (continued)

Description		Frame Size	Cat. No.	Used with PowerFlex Drive	
				753	755
Flange Adapter Kit	Converts Open Type drive to external heatsink (flange) with NEMA/UL Type 1 integrity backside. This kit is for use with IP20, NEMA/UL Type 0 drives and does not provide an air-tight or water-tight seal. Where sealing is required (for example, contaminated, dirty or wet environments), a drive with an "F" enclosure option must be used.	2	20-750-FLNG1-F2	✓	✓
		3	20-750-FLNG1-F3	✓	✓
		4	20-750-FLNG1-F4	✓	✓
		5	20-750-FLNG1-F5	✓	✓
	Converts Open Type drive to external heatsink (flange) with NEMA/UL Type 4X/12 integrity backside.	6	20-750-FLNG4-F6	✓	✓
		7	20-750-FLNG4-F7	✓	✓
L Bus Bar Kit	Includes three L bus bars ⁽³⁾	8...10	20-750-LBRKT1	—	✓
NEMA/UL Type 1 Option Kit	NEMA/UL Type 1 Kit	1	20-750-NEMA1-F1	✓	✓
		2	20-750-NEMA1-F2	✓	✓
		3	20-750-NEMA1-F3	✓	✓
		4	20-750-NEMA1-F4	✓	✓
		5	20-750-NEMA1-F5	✓	✓
		6	20-750-NEMA1-F6	✓	✓
		7	20-750-NEMA1-F7	✓	✓
Power Terminal Extension	Allows connection of two parallel leads to the AC terminals.	6	20-750-ACTE1-F6	✓	✓
Power Terminal Guard	Provides additional protection against contact with the power terminals.		20-750-PTG1-F6	✓	✓
			7	20-750-PTG1-F7	✓
Remote Control POD Mounting Kit	Hardware, fiber-optic, and power supply cables to remotely mount the control POD up to 23 m (75 ft) from the drive.	8...10	20-750-RPD1-F8	—	✓
Roll-out Cart	A wheeled roll-out cart that facilitates drive installation and removal. Recommended for PowerFlex 755 Frame 8...10 drives.		20-750-CART1-F8		✓

(1) Frame 8 and up drives can be powered from an external 24V DC source, a 20-750-APS is not required.

(2) Exhaust hood is standard on Frames 8...10, IP54-rated cabinets.

(3) Frame 8 drive is factory shipped with two L bus bars per phase as standard, Frame 9 drive is factory shipped with four L bus bars per phase as standard, and Frame 10 drive is factory shipped with six L bus bars per phase as standard.

PowerFlex 755T-Series Option Kits

Description	Cat. No.	Used with PowerFlex Drive	
		755TL	755TR
PowerFlex 750 Kit, AC Bus Bar, 600 mm, TE	20-750-MTEBUS1-4K7	✓	✓
PowerFlex 750 Kit, AC Bus Bar, 400 mm, TE	20-750-MTEBUS2-3K0	✓	✓
PowerFlex 750 Kit, AC Bus Bar, TE	20-750-MTESPL1-F8M	✓	✓
PowerFlex 750 Kit, AC Bus Bar, TE, Al	20-750-MTESPL2-F10M	✓	✓
PowerFlex 750 Kit, AC Bus Bar, TE, Cu	20-750-MTESPL3-F12M	✓	✓
PowerFlex 750 Kit, Floor Bracket, 800 mm	20-750-MMNT1-F10M	✓	✓
PowerFlex 750 Kit, Floor Bracket, 600 mm	20-750-MMNT1-F9M	✓	✓
PowerFlex 750 Kit, Floor Bracket, 400 mm	20-750-MMNT1-F8M	✓	✓
PowerFlex 750 Kit, Anti-tip	20-750-MINV-ATIP	✓	✓
PowerFlex 750 Kit, Power Module Cart	20-750-MCART1	✓	✓
PowerFlex 750 Kit, DC Precharge Module Lift ⁽¹⁾	20-750-MCART2	✓	✓
PowerFlex 750 Kit, External Baying	20-750-MEXTBAY1	✓	✓
PowerFlex 750 Kit, Service Ramp	20-750-MRAMP1	✓	✓
PowerFlex 750 Kit, Empty Option Bay, 600 mm	20-750-MPBAY-600	✓	✓
PowerFlex 750 Kit, Empty Option Bay, 800 mm	20-750-MPBAY-800	✓	✓
PowerFlex 750 Kit, Torque Accuracy Module, 400/480V	20-750-MTAM1-CD	✓	✓
PowerFlex 750 Kit, Torque Accuracy Module, 600/690V	20-750-MTAM1-EF	✓	✓
PowerFlex 750 Kit, Ground Clamp	SK-RM-GRNDCLMP-185	✓	✓
PowerFlex 750 Kit, Ground Clamp	SK-RM-GRNDCLMP-75	✓	✓
PowerFlex 750 Kit, Ground Clamp	SK-RM-GRNDCLMP-16	✓	✓
PowerFlex 750 Kit, Ground Clamp	SK-RM-GRNDCLMP-50	✓	✓
PowerFlex 750 Kit, DC Bus Conditioner	20-750-MDCBUS-COND	✓	✓
PowerFlex 750 Kit, AC Common Mode Core	20-750-MACCM1-F8M	✓	✓

(1) Requires 20-750-MCART1.

PowerFlex 70 Small Duty Internal Dynamic Brake Resistors

Limited duty resistors mount directly to the back surface of the drive and require no extra panel space. Internal resistors are non-destructive and do not require a resistor overheat external safety circuit.

PowerFlex 70 AC Drive			Small Duty Internal DB Resistor								
Normal Duty ⁽¹⁾ kW (Hp)	Heavy Duty ⁽¹⁾ kW (Hp)	Min DB Res Ohms ±10%	Cat. No.	Resistance ⁽²⁾ Ohms ±5%	Continuous Power kW	Max Energy kJ	Max Braking Torque % of ND Motor	Application Type 1		Application Type 2	
								Braking Torque % of ND Motor	Duty Cycle	Braking Torque % of ND Motor	Duty Cycle
200...240 Volt AC Input Drives											
0.37 (0.5)	0.25 (0.33)	33	20AB-DB1-A	62	0.048	8.3	307%	100%	25.9%	150%	17.3%
0.75 (1)	0.55 (0.75)		20AB-DB1-B								8.5%
1.5 (2)	1.1 (1.5)										2.5%
2.2 (3)	1.5 (2)	30	20AB-DB1-C	0.04	109%	60%	60%	3.3%	—	—	2.3%
4 (5)	3 (3)										1.1%
5.5 (7.5)	4 (5)		21								20AB-DB1-D
7.5 (10)	5.5 (7.5)	—	—								
400...480 Volt AC Input Drives											
0.37 (0.5)	0.25 (0.33)	68	20AD-DB1-A	115	0.048	8.3	320%	100%	25.9%	150%	17.3%
0.75 (1)	0.55 (0.75)		20AD-DB1-B								8.5%
1.5 (2)	1.1 (1.5)										4.3%
2.2 (3)	1.5 (2)	74	20AD-DB1-C	0.04	0.9	206%	129%	94%	1.5%	—	1.7%
4 (5)	3 (3)										1.1%
5.5 (7.5)	4 (5)		44								20AD-DB1-D
7.5 (10)	5.5 (7.5)	31	64%	64%							
500...600 Volt AC Input Drives											
0.37 (0.5)	0.25 (0.33)	117	20AD-DB1-A	115	0.048	8.3	287%	100%	25.9%	150%	17.3%
0.75 (1)	0.55 (0.75)		20AD-DB1-B								8.5%
1.5 (2)	1.1 (1.5)										4.3%
2.2 (3)	1.5 (2)	80	20AD-DB1-C	0.04	0.9	202%	193%	1.4%	1.5%	147%	1.7%
4.0 (5)	3.0 (3)										0.9%
5.5 (7.5)	4.0 (5)		48								—
7.5 (10)	5.5 (7.5)	48	—	—	—	—	—	—	—	—	—
11 (15)	7.5 (10)										—
15 (20)	11 (15)	—	—	—	—	—	—	—	—	—	—

(1) Duty cycle listed is based on full speed to zero speed deceleration. For constant regen at full speed, duty cycle capability is half of what is listed. Application Type 1 represents maximum capability up to 100% braking torque where possible. Application Type 2 represents more than 100% braking torque where possible, up to a maximum of 150%.

(2) Always check resistor Ohms against minimum resistance for drive being used.

PowerFlex 70 Medium Duty External Dynamic Brake Resistors

These resistors provide a larger duty cycle capability than the internal type. Includes an internal thermal switch for use in external safety circuit.

PowerFlex 70 AC Drive			Medium Duty External DB Resistor								
Normal Duty ⁽¹⁾ kW (Hp)	Heavy Duty ⁽¹⁾ kW (Hp)	Min DB Res Ohms ±10%	Cat. No.	Resistance ⁽²⁾ Ohms ±5%	Continuous Power kW	Max Energy kJ	Max Braking Torque % of ND Motor	Application Type 1		Application Type 2	
								Braking Torque % of ND Motor	Duty Cycle	Braking Torque % of ND Motor	Duty Cycle
200...240 Volt AC Input Drives											
0.37 (0.5)	0.25 (0.33)	33	AK-R2-091P500	91	0.086	17	293%	100%	46%	150%	31%
0.75 (1)	0.55 (0.75)						218%		23%		15%
1.5 (2)	1.1 (1.5)						109%		11%		109%
2.2 (3)	1.5 (2)	30	AK-R2-047P500	47	0.166	33	144%	79%	15%	144%	—
4 (5)	3 (3)						79%		11%	—	
5.5 (7.5)	4 (5)	23	AK-R2-030P1K2	30	0.26	52	90%	90%	10%	—	—
7.5 (10)	5.5 (7.5)						66%				
400...480 Volt AC Input Drives											
0.37 (0.5)	0.25 (0.33)	68	AK-R2-360P500	360	0.086	17	305%	100%	47%	150%	31%
0.75 (1)	0.55 (0.75)						220%		23%		15%
1.5 (2)	1.1 (1.5)						110%		12%		110%
2.2 (3)	1.5 (2)	74	AK-R2-120P1K2	120	0.26	52	197%	90%	24%	150%	16%
4 (5)	3 (3)						124%		13%	124%	10%
5.5 (7.5)	4 (5)	44	⁽³⁾	60	0.52	104	90%	90%	10%	—	—
7.5 (10)	5.5 (7.5)						66%				
11 (15) ⁽³⁾	7.5 (10) ⁽³⁾	31	⁽³⁾	60	0.52	104	90%	90%	10%	—	—
15 (20) ⁽³⁾	11 (15) ⁽³⁾						66%				
500...600 Volt AC Input Drives											
0.37 (0.5)	0.25 (0.33)	117	AK-R2-360P500	360	0.086	17	274%	100%	46%	150%	31%
0.75 (1)	0.55 (0.75)						251%		23%		15%
1.5 (2)	1.1 (1.5)						172%		11%		8%
2.2 (3)	1.5 (2)	80	AK-R2-120P1K2	120	0.26	52	193%	93%	24%	16%	
4 (5)	3 (3)						185%		13%	9%	
5.5 (7.5)	4 (5)	48	⁽³⁾	60	0.52	104	141%	103%	9%	141%	7%
7.5 (10)	5.5 (7.5)						103%		7%	103%	
11 (15) ⁽³⁾	7.5 (10) ⁽³⁾	48	⁽³⁾	60	0.52	104	141%	103%	9%	141%	7%
15 (20) ⁽³⁾	11 (15) ⁽³⁾						103%		7%	103%	

- (1) Duty cycle listed is based on full speed to zero speed deceleration. For constant regen at full speed, duty cycle capability is half of what is listed. Application Type 1 represents maximum capability up to 100% braking torque where possible. Application Type 2 represents more than 100% braking torque where possible, up to a maximum of 150%.
- (2) Always check resistor Ohms against minimum resistance for drive being used.
- (3) For 11 and 15 kW (15 and 20 Hp) applications, use two 7.5 kW (10 Hp) size resistors wired in parallel.

Internal Dynamic Brake Resistor Kits

These resistors have a limited duty cycle. Refer to the PowerFlex Dynamic Braking Resistor Calculator, publication [PFLEX-AT001](#) to determine if an internal resistor is sufficient for your application. An external resistor may be required.

Drive Input Voltage	Brake Resistance	Frame	Cat. No.	Used with PowerFlex Drive	
	Ω			70	753/755
380...600V AC	115	1 (1...3 Hp)	20-750-DB1-D1A	—	✓
	62	1 (5...10 Hp)	20-750-DB1-D1		✓
	62	2	20-750-DB1-D2		✓

Terminators

Description ⁽¹⁾	Cat. No.	Used with PowerFlex Drive	
		70	753/755
For use with 3.7 kW (5 Hp) and below drives	1204-TFA1	✓	✓
For use with 1.5 kW (2 Hp) and up drives	1204-TFB2	✓	✓

(1) For selection information, refer to Appendix A of the Wiring and Grounding Guidelines for Pulse Width Modulated (PWM) AC Drives, publication [DRIVES-IN001](#).

Reflected Wave Reduction Modules with Common Mode Choke

Description ⁽¹⁾	Cat. No.	Used with PowerFlex Drive	
		70	753/755
17A with Common Mode Choke	1204-RWC-17-A	✓	✓

(1) For selection information, refer to Appendix A of the Wiring and Grounding Guidelines for Pulse Width Modulated (PWM) AC Drives, publication [DRIVES-IN001](#).

Reflected Wave Reduction Modules

Voltage	ND kW	ND Hp	Cat. No.	Used with PowerFlex Drive	
				70	753/755
380...480V AC	4	5	1321-RWR8-DP	✓	✓
	5.5	7.5	1321-RWR12-DP	✓	✓
	7.5	10	1321-RWR18-DP	✓	✓
	11	15	1321-RWR25-DP	✓	✓
	15	20	1321-RWR35-DP	✓	✓
	18.5	25	1321-RWR35-DP	✓	✓
	22	30	1321-RWR45-DP	✓	✓
	30	40	1321-RWR55-DP	✓	✓
	37	50	1321-RWR80-DP	✓	✓
	45	60	1321-RWR80-DP	—	✓
	55	75	1321-RWR100-DP		✓
	75	100	1321-RWR130-DP		✓
	90	125	1321-RWR160-DP		✓
	110	150	1321-RWR200-DP		✓
	149	200	1321-RWR250-DP		✓
187	250	1321-RWR320-DP		✓	
500...600V AC	4	5	1321-RWR8-EP	✓	✓
	5.5	7.5	1321-RWR12-EP	✓	✓
	7.5	10	1321-RWR12-EP	✓	—
			1321-RWR18-EP	—	✓
	11	15	1321-RWR18-EP	✓	—
			1321-RWR25-EP	—	✓
	15	20	1321-RWR25-EP	✓	—
			1321-RWR35-EP	—	✓
	18.5	25	1321-RWR35-EP	✓	✓
			1321-RWR45-EP	—	✓
	22	30	1321-RWR35-EP	✓	—
			1321-RWR45-EP	—	✓
	30	40	1321-RWR45-EP	✓	—
			1321-RWR55-EP	—	✓
	37	50	1321-RWR55-EP	✓	—
			1321-RWR80-EP	—	✓
	45	60	1321-RWR80-EP		✓
	55	75	1321-RWR100-EP		✓
75	100	1321-RWR130-EP		✓	
90	125	1321-RWR160-EP		✓	
110	150	1321-RWR200-EP		✓	
149	200	1321-RWR250-EP		✓	

Isolation Transformers - IP32, NEMA/UL Type 3R Standalone, 4...6% Nominal Impedance

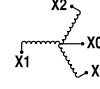
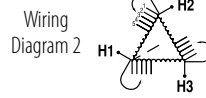
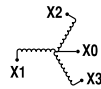
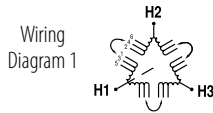

Motor Rating		Wiring Diagram	240V, 60 Hz, Three-Phase Primary & 240V Secondary ⁽¹⁾	460V, 60 Hz, Three-Phase Primary & 460V Secondary	575V, 60 Hz, Three-Phase Primary & 575V Secondary ⁽¹⁾	Used with PowerFlex Drive	
kW	Hp		Cat. No.	Cat. No.	Cat. No.	70	753/755
0.25	0.33	1	1321-3TW005-AA	1321-3TW005-BB	—	✓	—
0.37	0.5				1321-3TW005-CC	✓	✓
0.55	0.75				—	✓	—
0.75	1				1321-3TW005-CC	✓	✓
1.1	1.5				—	✓	—
1.5	2				1321-3TW005-CC	✓	✓
2.2	3				1321-3TW005-CC	✓	✓
22	30	2	1321-3TW040-AA	1321-3TW040-BB	1321-3TW040-CC	✓	✓
30	40		1321-3TW051-AA	1321-3TW051-BB	1321-3TW051-CC	✓	✓
37	50		1321-3TH063-AA	1321-3TH063-BB	1321-3TH063-CC	✓	✓
45	60		1321-3TH075-AA	1321-3TH075-BB	1321-3TH075-CC	—	✓
55	75		1321-3TH093-AA	1321-3TH093-BB	1321-3TH093-CC	—	✓
75	100		1321-3TH118-AA	1321-3TH118-BB	1321-3TH118-CC	—	✓
90	125		1321-3TH145-AA	1321-3TH145-BB	1321-3TH145-CC	—	✓
110	150		1321-3TH175-AA	1321-3TH175-BB	1321-3TH175-CC	—	✓
149	200		1321-3TH220-AA	1321-3TH220-BB	1321-3TH220-CC	—	✓
187	250		—	1321-3TH275-BB	1321-3TH275-CC	—	✓
224	300	1	—	1321-3TH330-BB	1321-3TH330-CC	—	✓
224	—		—	—	1321-3TH330-CC	—	✓
261	350		1321-3TH440-BB	1321-3TH440-CC	—	—	✓
298	400		1321-3TH440-BB	1321-3TH550-CC	—	—	✓
336	450		1321-3TH550-BB	1321-3TH550-CC	—	—	✓
373	500		1321-3TH550-BB	1321-3TH660-CC	—	—	✓
410	550		—	1321-3TH660-CC	—	—	✓
448	600		1321-3TH660-BB	1321-3TH770-CC	—	—	✓
522	700		1321-3TH770-BB	1321-3TH770-CC	—	—	✓
597	800		1321-3TH880-BB	1321-3TH880-CC	—	—	✓
671	900		—	900 kVA ⁽²⁾	950 kVA ⁽²⁾	—	✓
709	950		—	—	1000 kVA ⁽²⁾	—	✓
746	1000		—	1000 kVA ⁽²⁾	1100 kVA ⁽²⁾	—	✓
821	1100	—	1200 kVA ⁽²⁾	—	—	✓	
895	1200	—	—	1200 kVA ⁽²⁾	—	✓	
933	1250	—	1200 kVA ⁽²⁾	—	—	✓	
1007	1350	—	1300 kVA ⁽²⁾	—	—	✓	
1119	1500	—	1500 kVA ⁽²⁾	1500 kVA ⁽²⁾	—	✓	
1492	2000	—	2000 kVA ⁽²⁾	—	—	✓	

(1) Not applicable for the PowerFlex 755.

(2) 1321 Isolation Transformer solution is not available. Approximate drive kVA is listed.

Input and Output Reactors - 200...240V, 50/60 Hz, Three-Phase, 3% Impedance

kW	Hp	Duty	Input Line Reactor ⁽¹⁾		Output Reactor ⁽¹⁾		Used with PowerFlex Drive	
			IP00 (Open Style)	IP11 (NEMA/UL Type 1)	IP00 (Open Style)	IP11 (NEMA/UL Type 1)	70	753/755
0.25	0.33	Normal	1321-3R2-D	1321-3RA2-D	1321-3R2-D	1321-3RA2-D	✓	—
0.37	0.5	Normal	1321-3R2-D	1321-3RA2-D	1321-3R2-D	1321-3RA2-D	✓	✓
		Heavy	1321-3R2-D	1321-3RA2-D	1321-3R4-A	1321-3RA4-A	—	✓
0.55	0.75	Heavy	1321-3R4-A	1321-3RA4-A	1321-3R4-D	1321-3RA4-D	✓	—
0.75	1	Normal	1321-3R4-A	1321-3RA4-A	1321-3R4-A	1321-3RA4-A	✓	✓
		Heavy	1321-3R4-A	1321-3RA4-A	1321-3R8-A	1321-3RA8-A	—	✓
1.1	1.5	Heavy	1321-3R8-B	1321-3RA8-B	1321-3R8-B	1321-3RA8-B	✓	—
1.5	2	Normal	1321-3R8-A	1321-3RA8-A	1321-3R8-A	1321-3RA8-A	✓	✓
		Heavy	1321-3R8-A	1321-3RA8-A	1321-3R12-A	1321-3RA12-A	✓	✓
2.2	3	Normal	1321-3R12-A	1321-3RA12-A	1321-3R12-A	1321-3RA12-A	✓	✓
		Heavy	1321-3R12-A	1321-3RA12-A	1321-3R18-A	1321-3RA18-A	✓	✓
4	5	Normal	1321-3R18-A	1321-3RA18-A	1321-3R18-A	1321-3RA18-A	✓	✓
		Heavy	1321-3R18-A	1321-3RA18-A	1321-3R25-A	1321-3RA25-A	✓	✓
5.5	7.5	Normal	1321-3R25-A	1321-3RA25-A	1321-3R25-A	1321-3RA25-A	✓	✓
		Heavy	1321-3R25-A	1321-3RA25-A	1321-3R35-A	1321-3RA35-A	✓	✓
7.5	10	Normal	1321-3R35-A	1321-3RA35-A	1321-3R35-A	1321-3RA35-A	✓	✓
		Heavy	1321-3R35-A	1321-3RA35-A	1321-3R45-A	1321-3RA45-A	✓	✓
11	15	Normal	1321-3R45-A	1321-3RA45-A	1321-3R45-A	1321-3RA45-A	✓	✓
		Heavy	1321-3R45-A	1321-3RA45-A	1321-3R55-A	1321-3RA55-A	✓	✓
15	20	Normal	1321-3R55-A	1321-3RA55-A	1321-3R55-A	1321-3RA55-A	✓	✓
		Heavy	1321-3R55-A	1321-3RA55-A	1321-3R80-A	1321-3RA80-A	✓	✓
18.5	25	Normal	1321-3R80-A	1321-3RA80-A	1321-3R80-A	1321-3RA80-A	✓	✓
		Heavy	1321-3R80-A	1321-3RA80-A	1321-3R80-A	1321-3RA80-A	—	✓
22	30	Normal	1321-3R80-A	1321-3RA80-A	1321-3R80-A	1321-3RA80-A		✓
		Heavy	1321-3R80-A	1321-3RA80-A	1321-3R100-A	1321-3RA100-A		✓
30	40	Normal	1321-3R100-A	1321-3RA100-A	1321-3R100-A	1321-3RA100-A		✓
		Heavy	1321-3R100-A	1321-3RA100-A	1321-3R130-A	1321-3RA130-A		✓
37	50	Normal	1321-3R130-A	1321-3RA130-A	1321-3R130-A	1321-3RA130-A		✓
		Heavy	1321-3R130-A	1321-3RA130-A	1321-3R160-A	1321-3RA160-A		✓
45	60	Normal	1321-3R160-A	1321-3RA160-A	1321-3R160-A	1321-3RA160-A		✓
		Heavy	1321-3R160-A	1321-3RA160-A	1321-3R200-A	1321-3RA200-A		✓
55	75	Normal	1321-3R200-A	1321-3RA200-A	1321-3R200-A	1321-3RA200-A		✓
		Heavy	1321-3R200-A	1321-3RA200-A	1321-3RB320-A	1321-3RAB320-A		✓
66	100	Normal	1321-3RB320-A	1321-3RAB320-A	1321-3RB320-A	1321-3RAB320-A		✓
		Heavy	1321-3RB320-A	1321-3RAB320-A	1321-3RB320-A	1321-3RAB320-A		✓
90	125	Normal	1321-3RB320-A	1321-3RAB320-A	1321-3RB320-A	1321-3RAB320-A		✓
		Heavy	1321-3RB320-A	1321-3RAB320-A	1321-3RB400-A	1321-3RAB400-A		✓
110	150	Normal	1321-3RB400-A	1321-3RAB400-A	1321-3RB400-A	1321-3RAB400-A		✓
132	200	Normal	1321-3R500-A	1321-3RA500-A	1321-3R500-A	1321-3RA500-A		✓

(1) Input line reactors were sized based on the NEC fundamental motor amps. Output line reactors were sized based on the VFD rated output currents.

Input and Output Reactors - 200...240V, 50/60 Hz, Three-Phase, 5% Impedance

kW	Hp	Duty	Input Line Reactor ⁽¹⁾		Output Reactor ⁽¹⁾		Used with PowerFlex Drive	
			IP00 (Open Style)	IP11 (NEMA/UL Type 1)	IP00 (Open Style)	IP11 (NEMA/UL Type 1)	70	753/755
0.25	0.33	Heavy	1321-3R2-A	1321-3RA2-A	1321-3R2-A	1321-3RA2-A	✓	—
0.37	0.5	Normal	1321-3R2-A	1321-3RA2-A	1321-3R2-A	1321-3RA2-A	✓	✓
		Heavy	1321-3R2-A	1321-3RA2-A	1321-3R4-A	1321-3RA4-A	—	✓
0.55	0.75	Heavy	1321-3R4-B	1321-3RA4-B	1321-3R4-B	1321-3RA4-B	✓	—
0.75	1	Normal	1321-3R4-B	1321-3RA4-B	1321-3R4-B	1321-3RA4-B	✓	✓
		Heavy	1321-3R4-B	1321-3RA4-B	1321-3R8-B	1321-3RA8-B	—	✓
1.1	1.5	Heavy	1321-3R8-B	1321-3RA8-B	1321-3R8-B	1321-3RA8-B	✓	—
1.5	2	Normal	1321-3R8-B	1321-3RA8-B	1321-3R8-B	1321-3RA8-B	✓	✓
		Heavy	1321-3R8-B	1321-3RA8-B	1321-3R12-B	1321-3RA12-B	✓	✓
2.2	3	Normal	1321-3R12-B	1321-3RA12-B	1321-3R12-B	1321-3RA12-B	✓	✓
		Heavy	1321-3R12-B	1321-3RA12-B	1321-3R18-B	1321-3RA18-B	✓	✓
4	5	Normal	1321-3R18-B	1321-3RA18-B	1321-3R18-B	1321-3RA18-B	✓	✓
		Heavy	1321-3R18-B	1321-3RA18-B	1321-3R25-B	1321-3RA25-B	✓	✓
5.5	7.5	Normal	1321-3R25-B	1321-3RA25-B	1321-3R25-B	1321-3RA25-B	✓	✓
		Heavy	1321-3R25-B	1321-3RA25-B	1321-3R35-B	1321-3RA35-B	✓	✓
7.5	10	Normal	1321-3R35-B	1321-3RA35-B	1321-3R35-B	1321-3RA35-B	✓	✓
		Heavy	1321-3R35-B	1321-3RA35-B	1321-3R45-B	1321-3RA45-B	✓	✓
11	15	Normal	1321-3R45-B	1321-3RA45-B	1321-3R45-B	1321-3RA45-B	✓	✓
		Heavy	1321-3R45-B	1321-3RA45-B	1321-3R55-B	1321-3RA55-B	✓	✓
15	20	Normal	1321-3R55-B	1321-3RA55-B	1321-3R55-B	1321-3RA55-B	✓	✓
		Heavy	1321-3R55-B	1321-3RA55-B	1321-3R80-B	1321-3RA80-B	✓	✓
18.5	25	Normal	1321-3R80-B	1321-3RA80-B	1321-3R80-B	1321-3RA80-B	—	✓
		Heavy	1321-3R80-B	1321-3RA80-B	1321-3R80-B	1321-3RA80-B	—	✓
22	30	Normal	1321-3R80-B	1321-3RA80-B	1321-3R80-B	1321-3RA80-B	—	✓
		Heavy	1321-3R80-B	1321-3RA80-B	1321-3R100-B	1321-3RA100-B	—	✓
30	40	Normal	1321-3R100-B	1321-3RA100-B	1321-3R100-B	1321-3RA100-B	—	✓
		Heavy	1321-3R100-B	1321-3RA100-B	1321-3R130-B	1321-3RA130-B	—	✓
37	50	Normal	1321-3R130-B	1321-3RA130-B	1321-3R130-B	1321-3RA130-B	—	✓
		Heavy	1321-3R130-B	1321-3RA130-B	1321-3R160-B	1321-3RA160-B	—	✓
45	60	Normal	1321-3R160-B	1321-3RA160-B	1321-3R160-B	1321-3RA160-B	—	✓
		Heavy	1321-3R160-B	1321-3RA160-B	1321-3R200-B	1321-3RA200-B	—	✓
55	75	Normal	1321-3R200-B	1321-3RA200-B	1321-3R200-B	1321-3RA200-B	—	✓
		Heavy	1321-3R200-B	1321-3RA200-B	1321-3RB320-B	1321-3RAB320-B	—	✓
66	100	Normal	1321-3RB320-B	1321-3RAB320-B	1321-3RB320-B	1321-3RAB320-B	—	✓
		Heavy	1321-3RB320-B	1321-3RAB320-B	1321-3RB320-B	1321-3RAB320-B	—	✓
90	125	Normal	1321-3RB320-B	1321-3RAB320-B	1321-3RB320-B	1321-3RAB320-B	—	✓
		Heavy	1321-3RB320-B	1321-3RAB320-B	1321-3RB400-B	1321-3RAB400-B	—	✓
110	150	Normal	1321-3RB400-B	1321-3RAB400-B	1321-3RB400-B	1321-3RAB400-B	—	✓
132	200	Normal	1321-3R500-B	1321-3RA500-B	1321-3R500-B	1321-3RA500-B	—	✓

(1) Input line reactors were sized based on the NEC fundamental motor amps. Output line reactors were sized based on the VFD rated output currents.

Input and Output Reactors - 380...480V, 50/60 Hz, Three-Phase, 3% Impedance

kW	Hp	Duty	Input Line Reactor ⁽¹⁾		Output Reactor ⁽¹⁾		Used with PowerFlex Drive	
			IP00 (Open Style)	IP11 (NEMA/UL Type 1)	IP00 (Open Style)	IP11 (NEMA/UL Type 1)	70	753/755
0.25	0.33	Heavy	1321-3R1-C	1321-3RA1-C	1321-3R2-B	1321-3RA2-B	✓	—
0.37	0.5	Normal					✓	
0.55	0.75	Heavy	1321-3R2-A	1321-3RA2-A	1321-3R2-A	1321-3RA2-A	✓	
0.75	1	Normal					✓	✓
1.1	1.5	Heavy	1321-3R4-C	1321-3RA4-C	1321-3R4-B	1321-3RA4-B	✓	✓
1.5	2	Normal	1321-3R4-B	1321-3RA4-B			1321-3R8-C	1321-3RA8-C
		Heavy			✓	✓		
2.2	3	Normal	1321-3R8-C	1321-3RA8-C	1321-3R8-B	1321-3RA8-B	✓	✓
		Heavy					✓	✓
4	5	Normal	1321-3R8-B	1321-3RA8-B	1321-3R12-B	1321-3RA12-B	✓	✓
		Heavy					✓	✓
5.5	7.5	Normal	1321-3R12-B	1321-3RA12-B	1321-3R18-B	1321-3RA18-B	✓	✓
		Heavy					✓	✓
7.5	10	Normal	1321-3R18-B	1321-3RA18-B	1321-3R25-B	1321-3RA25-B	✓	✓
		Heavy					✓	✓
11	15	Normal	1321-3R25-B	1321-3RA25-B	1321-3R35-B	1321-3RA35-B	✓	✓
		Heavy					✓	✓
15	20	Normal	1321-3R35-B	1321-3RA35-B	1321-3R45-B	1321-3RA45-B	✓	✓
		Heavy					✓	✓
18.5	25	Normal	1321-3R45-B	1321-3RA45-B	1321-3R55-B	1321-3RA55-B	✓	✓
		Heavy					✓	✓
22	30	Normal	1321-3R45-B	1321-3RA45-B	1321-3R80-B	1321-3RA80-B	✓	✓
		Heavy					✓	✓
30	40	Normal	1321-3R55-B	1321-3RA55-B	1321-3R80-B	1321-3RA80-B	✓	✓
		Heavy					✓	✓
37	50	Normal	1321-3R80-B	1321-3RA80-B	1321-3R100-B	1321-3RA100-B	✓	✓
		Heavy					✓	✓
45	60	Normal/Heavy	1321-3R100-B	1321-3RA100-B	1321-3R130-B	1321-3RA130-B	—	✓
55	75						✓	
75	100						✓	
90	125						✓	
110	150	Normal	1321-3R200-B	1321-3RA200-B	1321-3R200-C	1321-3RA200-C	✓	✓
		Heavy					✓	
—	200	Normal/Heavy	1321-3RB250-B	1321-3RAB250-B	1321-3RB320-B	1321-3RAB320-B	✓	✓
132	—						✓	
160	250						✓	
200	300						✓	
—	350	Normal	1321-3RB400-B	1321-3RAB400-B	1321-3RB400-B	1321-3RAB400-B	✓	✓
		Heavy					✓	
—	250	Normal/Heavy	1321-3R500-B	1321-3RA500-B	1321-3R500-B	1321-3RA500-B	✓	✓
250	—						✓	

(table continues on next page)

Input and Output Reactors - 380...480V, 50/60 Hz, Three-Phase, 3% Impedance (continued)

kW	Hp	Duty ⁽²⁾	Input Line Reactor ⁽¹⁾		Output Reactor ⁽¹⁾		Used with PowerFlex Drive
			IP00 (Open Style)	IP11 (NEMA/UL Type 1)	IP00 (Open Style)	IP11 (NEMA/UL Type 1)	753/755
—	400	Light/Normal/Heavy	1321-3R500-B	1321-3RA500-B	1321-3R500-B	1321-3RA500-B	✓
315	—		1321-3R600-B	1321-3RA600-B	1321-3R600-B	1321-3RA600-B	✓
—	450		—	—	—	—	✓
355	—		1321-3R750-B	1321-3RA750-B	1321-3R750-B	1321-3RA750-B	✓
—	500	Light	1321-3R600-B	1321-3RA600-B	1321-3R600-B	1321-3RA600-B	✓
—		Normal/Heavy	1321-3R750-B	1321-3RA750-B	1321-3R750-B	1321-3RA750-B	✓
400	—	Light/Heavy	—	—	—	—	✓
		Normal	1321-3R850-B	1321-3RA850-B	1321-3R850-B	1321-3RA850-B	✓
—	600	Light/Normal/Heavy	1321-3R750-B	1321-3RA750-B	1321-3R750-B	1321-3RA750-B	✓
450	—	Light	1321-3R850-B	1321-3RA850-B	1321-3R850-B	1321-3RA850-B	✓
—	650		—	—	—	—	✓
—	—	Normal	1321-3R750-B	1321-3RA750-B	1321-3R750-B	1321-3RA750-B	✓
—	700	Light/Normal/Heavy	1321-3R850-B	1321-3RA850-B	1321-3R850-B	1321-3RA850-B	✓
—	750	Heavy	—	—	—	—	✓
500	—	Normal/Heavy	1321-3R1000-B	1321-3RA1000-B	1321-3R1000-B	1321-3RA1000-B	✓
—	800	Light/Normal/Heavy	—	—	—	—	✓
560	—		1321-3R600-B	1321-3RA600-B	1321-3R600-B	1321-3RA600-B	✓ ⁽³⁾
630	900		—	—	1321-3R600-B	1321-3RA600-B	✓ ⁽³⁾
710	1000		—	—	—	—	✓ ⁽³⁾
800	1100	Light/Normal	1321-3R750-B	1321-3RA750-B	1321-3R750-B	1321-3RA750-B	✓ ⁽³⁾
850	—		—	—	—	—	✓ ⁽³⁾
900	—	Light	1321-3R850-B	1321-3RA850-B	1321-3R850-B	1321-3RA850-B	✓ ⁽³⁾
—	1250	Light/Normal	1321-3R750-B	1321-3RA750-B	1321-3R750-B	1321-3RA750-B	✓ ⁽³⁾
—	1350	Light	1321-3R850-B	1321-3RA850-B	1321-3R850-B	1321-3RA850-B	✓ ⁽³⁾
—	1500						✓ ⁽⁴⁾
1000	—						✓ ⁽⁴⁾
—	2000						✓ ⁽⁴⁾
—	—						✓ ⁽⁴⁾
1400	—						✓ ⁽⁴⁾

(1) Input line reactors were sized based on the NEC fundamental motor amps. Output line reactors were sized based on the VFD rated output currents.

(2) Light Duty refers only to PowerFlex 755 drives.

(3) Requires two reactors wired in parallel.

(4) Requires three reactors wired in parallel.

Input and Output Reactors - 380...480V, 50/60 Hz, Three-Phase, 5% Impedance

kW	Hp	Duty	Input Line Reactor ⁽¹⁾		Output Reactor ⁽¹⁾		Used with PowerFlex Drive	
			IP00 (Open Style)	IP11 (NEMA/UL Type 1)	IP00 (Open Style)	IP11 (NEMA/UL Type 1)	70	753/755
0.25	0.33	Heavy	1321-3R1-B	1321-3RA1-B	1321-3R2-C	1321-3RA2-C	✓	—
0.37	0.5	Normal					✓	
0.55	0.75	Heavy	1321-3R2-C	1321-3RA2-C	1321-3R2-B	1321-3RA2-B	✓	
0.75	1	Normal					✓	✓
1.1	1.5	Heavy	1321-3R4-D	1321-3RA4-D	1321-3R4-D	1321-3RA4-D	✓	✓
1.5	2	Normal					✓	✓
		Heavy					1321-3R8-D	1321-3RA8-D
2.2	3	Normal	1321-3R8-C	1321-3RA8-C	✓	✓		
		Heavy			✓	✓		
4	5	Normal	1321-3R8-C	1321-3RA8-C	1321-3R12-C	1321-3RA12-C	✓	✓
		Heavy					✓	✓
5.5	7.5	Normal	1321-3R12-C	1321-3RA12-C	1321-3R18-C	1321-3RA18-C	✓	✓
		Heavy					✓	✓
7.5	10	Normal	1321-3R18-C	1321-3RA18-C	1321-3R25-C	1321-3RA25-C	✓	✓
		Heavy					✓	✓
11	15	Normal/Heavy	1321-3R25-C	1321-3RA25-C	1321-3R25-C	1321-3RA25-C	✓	✓
15	20	Normal					1321-3R35-C	1321-3RA35-C
18.5	25	Heavy	1321-3R45-C	1321-3RA45-C	1321-3R45-C	1321-3RA45-C		
		Normal					✓	✓
22	30	Normal	1321-3R45-C	1321-3RA45-C	1321-3R55-C	1321-3RA55-C	✓	✓
		Heavy					✓	✓
30	40	Normal	1321-3R55-C	1321-3RA55-C	1321-3R80-C	1321-3RA80-C	✓	✓
		Heavy					✓	✓
37	50	Normal	1321-3R80-C	1321-3RA80-C	1321-3R80-C	1321-3RA80-C	✓	✓
		Heavy					—	✓
45	60	Normal/Heavy	1321-3R100-C	1321-3RA100-C	1321-3R100-C	1321-3RA100-C	✓	
55	75	Normal					✓	
75	100	Normal	1321-3R130-C	1321-3RA130-C	1321-3R130-C	1321-3RA130-C	✓	
90	125	Normal	1321-3R160-C	1321-3RA160-C	1321-3R160-C	1321-3RA160-C	✓	
110	150	Normal	1321-3R200-C	1321-3RA200-C	1321-3R200-C	1321-3RA200-C	✓	
		Heavy					✓	
—	200	Normal/Heavy	1321-3RB250-C	1321-3RAB250-C	1321-3RB250-C	1321-3RAB250-C	✓	
132	—		1321-3RB320-C	1321-3RAB320-C	1321-3RB320-C	1321-3RAB320-C	✓	
160	250	Normal/Heavy	1321-3RB400-C	1321-3RAB400-C	1321-3RB400-C	1321-3RAB400-C	✓	
—	300						✓	
200	—	Normal/Heavy	1321-3R500-C	1321-3RA500-C	1321-3R500-C	1321-3RA500-C	✓	
—	350						✓	
250	—	Normal/Heavy	1321-3R500-C	1321-3RA500-C	1321-3R500-C	1321-3RA500-C	✓	

(table continues on next page)

Input and Output Reactors - 380...480V, 50/60 Hz, Three-Phase, 5% Impedance (continued)

kW	Hp	Duty ⁽²⁾	Input Line Reactor ⁽¹⁾		Output Reactor ⁽¹⁾		Used with PowerFlex Drive		
			IP00 (Open Style)	IP11 (NEMA/UL Type 1)	IP00 (Open Style)	IP11 (NEMA/UL Type 1)	753/755		
—	400	Light/Normal/Heavy	1321-3R500-C	1321-3RA500-C	1321-3R500-C	1321-3RA500-C	✓		
315	—		1321-3R600-C	1321-3RA600-C	1321-3R600-C	1321-3RA600-C	✓		
—	450		—	—	—	—	✓		
355	—		1321-3R750-C	1321-3RA750-C	1321-3R750-C	1321-3RA750-C	✓		
—	500	Light	1321-3R600-C	1321-3RA600-C	1321-3R600-C	1321-3RA600-C	✓		
—		Normal/Heavy	1321-3R750-C	1321-3RA750-C	1321-3R750-C	1321-3RA750-C	✓		
400	—	Light/Heavy	—	—	—	—	✓		
		Normal	1321-3R850-C	1321-3RA850-C	1321-3R850-C	1321-3RA850-C	✓		
—	600	Light/Normal/Heavy	1321-3R750-C	1321-3RA750-C	1321-3R750-C	1321-3RA750-C	✓		
450	—	Light	1321-3R850-C	1321-3RA850-C	1321-3R850-C	1321-3RA850-C	✓		
500	—	Normal/Heavy	1321-3R1000-C	1321-3RA1000-C	1321-3R1000-C	1321-3RA1000-C	✓		
—	650	Light	1321-3R850-C	1321-3RA850-C	1321-3R850-C	1321-3RA850-C	✓		
		Normal	1321-3R750-C	1321-3RA750-C	1321-3R750-C	1321-3RA750-C	✓		
—	700	Light/Normal/Heavy	1321-3R850-C	1321-3RA850-C	1321-3R850-C	1321-3RA850-C	✓		
—	750	Heavy					✓		
—	800	Light/Normal/Heavy	1321-3R1000-C	1321-3RA1000-C	1321-3R1000-C	1321-3RA1000-C	✓		
560			—	1321-3R600-C	1321-3RA600-C	1321-3R600-C	1321-3RA600-C	✓ ⁽³⁾	
630			—	—	—	—	—	✓ ⁽³⁾	
—			900	—	—	—	—	✓ ⁽³⁾	
710			—	—	—	—	—	✓ ⁽³⁾	
—			1000	—	—	—	—	✓ ⁽³⁾	
—			1100	Light/Normal	1321-3R750-C	1321-3RA750-C	1321-3R750-C	1321-3RA750-C	✓ ⁽³⁾
800									—
850	—	✓ ⁽³⁾							
—	1250	—	—	—	—	✓ ⁽³⁾			
900	—	Light	1321-3R850-C	1321-3RA850-C	1321-3R850-C	1321-3RA850-C	✓ ⁽³⁾		
—	1350						✓ ⁽³⁾		
—	1500						✓ ⁽⁴⁾		
1000	—						✓ ⁽⁴⁾		
—	2000						✓ ⁽⁴⁾		
1400	—						✓ ⁽⁴⁾		

(1) Input line reactors were sized based on the NEC fundamental motor amps. Output line reactors were sized based on the VFD rated output currents.

(2) Light Duty refers only to PowerFlex 755 drives.

(3) Requires two output reactors wired in parallel.

(4) Requires three reactors wired in parallel.

Input and Output Reactors - 500...690V, 50/60 Hz, Three-Phase, 3% Impedance

kW	Hp	Duty	Input Line Reactor ⁽¹⁾		Output Reactor ⁽¹⁾		Used with PowerFlex Drive	
			IP00 (Open Style)	IP11 (NEMA/UL Type 1)	IP00 (Open Style)	IP11 (NEMA/UL Type 1)	70	753/755
0.25	0.33	Heavy	1321-3R1-C ⁽²⁾	1321-3RA1-C ⁽²⁾	1321-3R1-B ⁽²⁾	1321-3RA1-B ⁽²⁾	✓	—
0.37	0.5	Normal					✓	
0.55	0.75	Heavy	1321-3R2-B ⁽²⁾	1321-3RA2-B ⁽²⁾	1321-3R2-B ⁽²⁾	1321-3RA2-B ⁽²⁾	✓	—
0.75	1	Normal					✓	
		Heavy	1321-3R2-A ⁽²⁾	-1321-3RA2-A ⁽²⁾	1321-3R4-D ⁽²⁾	1321-3RA4-D ⁽²⁾	—	✓
1.1	1.5						✓	
1.5	2	Normal	1321-3R4-C ⁽²⁾	1321-3RA4-C ⁽²⁾	1321-3R4-D ⁽²⁾	1321-3RA4-D ⁽²⁾	✓	—
		Heavy					✓	
		Normal	1321-3R4-D ⁽²⁾	1321-3RA4-D ⁽²⁾	1321-3R4-D ⁽²⁾	1321-3RA4-D ⁽²⁾	—	✓
		Heavy					✓	
2.2	3	Normal	1321-3R4-C ⁽²⁾	1321-3RA4-C ⁽²⁾	1321-3R4-C ⁽²⁾	1321-3RA4-C ⁽²⁾	✓	✓
		Heavy					✓	
4	5	Normal	1321-3R8-C ⁽²⁾	1321-3RA8-C ⁽²⁾	1321-3R8-C ⁽²⁾	1321-3RA8-C ⁽²⁾	✓	✓
		Heavy					✓	
5.5	7.5	Normal	1321-3R12-C ⁽²⁾	1321-3RA12-C ⁽²⁾	1321-3R12-C ⁽²⁾	1321-3RA12-C ⁽²⁾	✓	✓
		Heavy					✓	
7.5	10	Normal	1321-3R12-B ⁽²⁾	1321-3RA12-B ⁽²⁾	1321-3R12-B ⁽²⁾	1321-3RA12-B ⁽²⁾	✓	✓
		Heavy					✓	
11	15	Normal	1321-3R18-B ⁽²⁾	1321-3RA18-B ⁽²⁾	1321-3R18-B ⁽²⁾	1321-3RA18-B ⁽²⁾	✓	✓
		Heavy					✓	
15	20	Normal	1321-3R25-B ⁽²⁾	1321-3RA25-B ⁽²⁾	1321-3R25-B ⁽²⁾	1321-3RA25-B ⁽²⁾	✓	✓
		Heavy					✓	
18.5	25	Normal	1321-3R35-C ⁽²⁾	1321-3RA35-C ⁽²⁾	1321-3R35-C ⁽²⁾	1321-3RA35-C ⁽²⁾	✓	✓
		Heavy					✓	
22	30	Normal	1321-3R35-B ⁽²⁾	1321-3RA35-B ⁽²⁾	1321-3R35-B ⁽²⁾	1321-3RA35-B ⁽²⁾	✓	✓
		Heavy					✓	
30	40	Normal	1321-3R45-B ⁽²⁾	1321-3RA45-B ⁽²⁾	1321-3R45-B ⁽²⁾	1321-3RA45-B ⁽²⁾	✓	✓
		Heavy					✓	
37	50	Normal	1321-3R55-B	1321-3RA55-B	1321-3R55-B	1321-3RA55-B	✓	✓
		Heavy					✓	
45	60	Normal/Heavy	1321-3R80-B	1321-3RA80-B	1321-3R80-B	1321-3RA80-B	—	✓
55	75						✓	
75	100						✓	
90	125						✓	
110	150	Normal	1321-3R100-B	1321-3RA100-B	1321-3R100-B	1321-3RA100-B	✓	✓
—	300	Heavy	1321-3RB320-B	1321-3RAB320-B	1321-3RB320-B	1321-3RAB320-B	✓	✓
200	—						✓	
—	350	Light/Normal/Heavy	1321-3RB400-B	1321-3RAB400-B	1321-3RB400-B	1321-3RAB400-B	✓	✓
250	—	Normal/Heavy	1321-3RB320-B	1321-3RAB320-B	1321-3RB320-B	1321-3RAB320-B	✓	✓

(table continues on next page)

Input and Output Reactors - 500...690V, 50/60 Hz, Three-Phase, 3% Impedance (continued)

kW	Hp	Duty	Input Line Reactor ⁽¹⁾		Output Reactor ⁽¹⁾		Used with PowerFlex Drive
			IP00 (Open Style)	IP11 (NEMA/UL Type 1)	IP00 (Open Style)	IP11 (NEMA/UL Type 1)	753/755
—	400	Light/Normal/Heavy	1321-3RB400-B	1321-3RAB400-B	1321-3RB400-B	1321-3RAB400-B	✓
300	—	Heavy					✓
—	450	Light/Normal/Heavy	1321-3R500-B	1321-3RA500-B	1321-3R500-B	1321-3RA500-B	✓
315	—	Light/Normal	1321-3RB400-B	1321-3RAB400-B	1321-3RB400-B	1321-3RAB400-B	✓
—	500	Light/Normal/Heavy	1321-3R600-B	1321-3RA600-B	1321-3R600-B	1321-3RA600-B	✓
355	—		1321-3R500-B	1321-3RA500-B	1321-3R500-B	1321-3RA500-B	✓
—	550	Light	1321-3R600-B	1321-3RA600-B	1321-3R600-B	1321-3RA600-B	✓
375	—	Heavy	1321-3R500-B	1321-3RA500-B	1321-3R500-B	1321-3RA500-B	✓
400	—	Light/Normal/Heavy					✓
—	600	Normal/Heavy	1321-3R600-B	1321-3RA600-B	1321-3R600-B	1321-3RA600-B	✓
450	—	Light/Normal					✓
500	—	Light/Normal/Heavy					✓
—	700		1321-3R750-B	1321-3RA750-B	1321-3R750-B	1321-3RA750-B	✓
530	—	Light	1321-3R600-B	1321-3RA600-B	1321-3R600-B	1321-3RA600-B	✓
560	—	Normal/Heavy	1321-3R750-B	1321-3RA750-B	1321-3R750-B	1321-3RA750-B	✓
—	750	Heavy					✓
—	800	Light/Normal/Heavy	1321-3R850-B	1321-3RA850-B	1321-3R850-B	1321-3RA850-B	✓
630	—		1321-3R750-B	1321-3RA750-B	1321-3R750-B	1321-3RA750-B	✓
—	900		1321-3R850-B	1321-3RA850-B	1321-3R850-B	1321-3RA850-B	✓
710	—						✓
—	950	Light/Normal	1321-3R1000-B	1321-3RA1000-B	1321-3R1000-B	1321-3RA1000-B	✓
750	—	Normal	1321-3R850-B	1321-3RA850-B	1321-3R850-B	1321-3RA850-B	✓
800	—	Light/Normal/Heavy	1321-3R1000-B	1321-3RA1000-B	1321-3R1000-B	1321-3RA1000-B	✓
—	1000	Light/Normal					✓
—	1100	Light	1321-3R600-B	1321-3RA600-B	1321-3R600-B	1321-3RA600-B	✓ ⁽³⁾
850	—		1321-3R1000-B	1321-3RA1000-B	1321-3R1000-B	1321-3RA1000-B	✓
900	—	Light/Normal	1321-3R600-B	1321-3RA600-B	1321-3R600-B	1321-3RA600-B	✓ ⁽³⁾
1000	—	Light	1321-3R600-B	1321-3RA600-B			✓ ⁽³⁾
1100	—	Light/Normal					✓ ⁽⁴⁾
—	1200	Light					✓ ⁽⁴⁾
1500	—	Light/Normal					✓ ⁽⁴⁾
—	1500	Light					✓ ⁽⁴⁾

(1) Input line reactors were sized based on the NEC fundamental motor amps. Output line reactors were sized based on the VFD rated output currents.

(2) Only rated for 600V and cannot be used on 690V applications.

(3) Requires two reactors wired in parallel.

(4) Requires three reactors wired in parallel.

Input and Output Reactors - 500...690V, 50/60 Hz, Three-Phase, 5% Impedance

kW	Hp	Duty	Input Line Reactor ⁽¹⁾		Output Reactor ⁽¹⁾		Used with PowerFlex Drive	
			IP00 (Open Style)	IP11 (NEMA/UL Type 1)	IP00 (Open Style)	IP11 (NEMA/UL Type 1)	70	753/755
0.25	0.33	Heavy	1321-3R1-A ⁽²⁾	1321-3RA1-A ⁽²⁾	1321-3R1-B ⁽²⁾	1321-3RA1-B ⁽²⁾	✓	—
0.37	0.5	Normal	1321-3R1-B ⁽²⁾	1321-3RA1-B ⁽²⁾			✓	—
0.55	0.75	Heavy	1321-3R2-C ⁽²⁾	1321-3RA2-C ⁽²⁾	1321-3R2-C ⁽²⁾	1321-3RA2-C ⁽²⁾	✓	—
0.75	1	Normal					✓	✓
		Heavy	—	✓				
1.1	1.5		1321-3R2-B ⁽²⁾	1321-3RA2-B ⁽²⁾	1321-3R4-D ⁽²⁾	1321-3RA4-D ⁽²⁾	✓	—
1.5	2	Normal/Heavy	1321-3R4-D ⁽²⁾	1321-3RA4-D ⁽²⁾			✓	✓
2.2	3	Normal	1321-3R8-D ⁽²⁾	1321-3RA8-D ⁽²⁾	1321-3R8-D ⁽²⁾	1321-3RA8-D ⁽²⁾	✓	✓
		Heavy					✓	✓
4	5	Normal	1321-3R12-C ⁽²⁾	1321-3RA12-C ⁽²⁾	1321-3R12-C ⁽²⁾	1321-3RA12-C ⁽²⁾	✓	✓
		Heavy					✓	✓
5.5	7.5	Normal/Heavy	1321-3R18-C ⁽²⁾	1321-3RA18-C ⁽²⁾	1321-3R18-C ⁽²⁾	1321-3RA18-C ⁽²⁾	✓	✓
7.5	10	Normal					✓	✓
		Heavy	1321-3R25-C ⁽²⁾	1321-3RA25-C ⁽²⁾	1321-3R25-C ⁽²⁾	1321-3RA25-C ⁽²⁾	✓	✓
11	15	Normal	1321-3R35-C ⁽²⁾	1321-3RA35-C ⁽²⁾	1321-3R35-C ⁽²⁾	1321-3RA35-C ⁽²⁾	✓	✓
		Heavy					✓	✓
15	20	Normal	1321-3R45-C ⁽²⁾	1321-3RA45-C ⁽²⁾	1321-3R45-C ⁽²⁾	1321-3RA45-C ⁽²⁾	✓	✓
		Heavy					✓	✓
18.5	25	Normal/Heavy	1321-3R55-C	1321-3RA55-C	1321-3R55-C	1321-3RA55-C	✓	✓
22	30	Normal					✓	✓
		Heavy	1321-3R80-C	1321-3RA80-C	1321-3R80-C	1321-3RA80-C	✓	✓
30	40	Normal	1321-3R100-C	1321-3RA100-C	1321-3R100-C	1321-3RA100-C	✓	✓
		Heavy					✓	✓
37	50	Normal	1321-3R130-C	1321-3RA130-C	1321-3R130-C	1321-3RA130-C	✓	✓
		Heavy					✓	✓
—	300	Heavy	1321-3R160-C	1321-3RA160-C	1321-3R160-C	1321-3RA160-C	✓	✓
			1321-3RB320-C	1321-3RAB320-C	1321-3RB320-C	1321-3RAB320-C	✓	✓
200	—	Light/Normal/Heavy	1321-3R250-C	1321-3RA250-C	1321-3R250-C	1321-3RA250-C	✓	✓
			1321-3R400-C	1321-3RAB400-C	1321-3RB400-C	1321-3RAB400-C	✓	✓
250	—	Normal/Heavy	1321-3R320-C	1321-3RAB320-C	1321-3RB320-C	1321-3RAB320-C	✓	✓
			1321-3R400-C	1321-3RAB400-C	1321-3RB400-C	1321-3RAB400-C	✓	✓
—	400	Light/Normal/Heavy	1321-3R400-C	1321-3RAB400-C	1321-3RB400-C	1321-3RAB400-C	✓	✓

(table continues on next page)

Input and Output Reactors - 500...690V, 50/60 Hz, Three-Phase, 5% Impedance (continued)

kW	Hp	Duty	Input Line Reactor ⁽¹⁾		Output Reactor ⁽¹⁾		Used with PowerFlex Drive
			IP00 (Open Style)	IP11 (NEMA/UL Type 1)	IP00 (Open Style)	IP11 (NEMA/UL Type 1)	753/755
300	—	Heavy	1321-3RB400-C	1321-3RAB400-C	1321-3RB400-C	1321-3RAB400-C	✓
315	—	Light/Normal					✓
—	450	Light/Normal/Heavy	1321-3R500-C	1321-3RA500-C	1321-3R500-C	1321-3RA500-C	✓
—	500	Light/Normal	1321-3R600-C	1321-3RA600-C	1321-3R600-C	1321-3RA600-C	✓
355	—	Light/Normal/Heavy	1321-3R500-C	1321-3RA500-C	1321-3R500-C	1321-3RA500-C	✓
—	550	Light	1321-3R600-C	1321-3RA600-C	1321-3R600-C	1321-3RA600-C	✓
375	—	Heavy	1321-3R500-C	1321-3RA500-C	1321-3R500-C	1321-3RA500-C	✓
400	—	Light/Normal/Heavy					✓
—	600	Normal/Heavy	1321-3R600-C	1321-3RA600-C	1321-3R600-C	1321-3RA600-C	✓
450	—	Light/Normal/Heavy					✓
500	—	Heavy					✓
—	700	Light/Normal/Heavy					✓
530	—	Light	1321-3R600-C	1321-3RA600-C	1321-3R600-C	1321-3RA600-C	✓
—	750	Heavy	1321-3R750-C	1321-3RA750-C	1321-3R750-C	1321-3RA750-C	✓
560	—	Normal/Heavy					✓
—	800	Light/Normal/Heavy	1321-3R850-C	1321-3RA850-C	1321-3R850-C	1321-3RA850-C	✓
630	—		1321-3R750-C	1321-3RA750-C	1321-3R750-C	1321-3RA750-C	✓
—	900		1321-3R850-C	1321-3RA850-C	1321-3R850-C	1321-3RA850-C	✓
—	950	Light/Normal	1321-3R1000-C	1321-3RA1000-C	1321-3R1000-C	1321-3RA1000-C	✓
710	—	Light/Normal/Heavy	1321-3R850-C	1321-3RA850-C	1321-3R850-C	1321-3RA850-C	✓
750	—	Normal					✓
—	1000	Light/Normal	1321-3R1000-C	1321-3RA1000-C	1321-3R1000-C	1321-3RA1000-C	✓
800	—	Light/Normal/Heavy					✓
—	1100	Light	1321-3R600-C	1321-3RA600-C	1321-3R600-C	1321-3RA600-C	✓ ⁽³⁾
850	—		1321-3R1000-C	1321-3RA1000-C	1321-3R1000-C	1321-3RA1000-C	✓
900	—	Light/Normal	1321-3R600-C	1321-3RA600-C	1321-3R600-C	1321-3RA600-C	✓ ⁽³⁾
1000	—	Light					✓ ⁽³⁾
1100	—	Light/Normal					✓ ⁽⁴⁾
—	1200	Light					✓ ⁽⁴⁾
1500	—	Light/Normal					✓ ⁽⁴⁾
—	1500	Light					✓ ⁽⁴⁾

(1) Input line reactors were sized based on the NEC fundamental motor amps. Output line reactors were sized based on the VFD rated output currents.

(2) Only rated for 600V and cannot be used on 690V applications.

(3) Requires two output reactors wired in parallel.

(4) Requires three reactors wired in parallel.

PowerFlex DC Drive

1.2...1044 kW/1.5...1400 Hp in voltages from 200...690V

The PowerFlex DC drive combines powerful performance with flexible control to produce a highly functional, cost effective drive and control solution. This drive also offers many features that allow the user to easily configure the drive for most application needs. Drive modules are available in IP20 Open Type enclosures, in both regenerative and non-regenerative configurations. The PowerFlex DC comes standard with an armature converter, regulated field converter for field weakening or economy applications, an advanced regulator with integrated DPI functionality, DC tachometer, and encoder capability.

PowerFlex DC at a Glance

Ratings	
200...240V	1.2...224 kW / 1.5...300 Hp / 7...1050 A
380...480V	1.5...671 kW / 2...900 Hp / 4.1...1494 A
500...600V	37...932 kW / 50...1250 Hp / 67.5...1688 A
690V	298...1044 kW / 400...1400 Hp / 452...1582 A
Motor Control	<ul style="list-style-type: none"> • Regenerative and Non-regenerative • Field Weakening and Economize
Enclosures	<ul style="list-style-type: none"> • IP20, NEMA/UL Type Open
Additional Features	<ul style="list-style-type: none"> • Overload Protection • PID Control (Speed or Torque) • Adaptive Gain, Droop, Feedback Loss Switchover • TorqProve™ Control
Certifications	<ul style="list-style-type: none"> • c-UL-us • CE • EAC • KCC • RCM • RoHS
Options	See pages 152...162

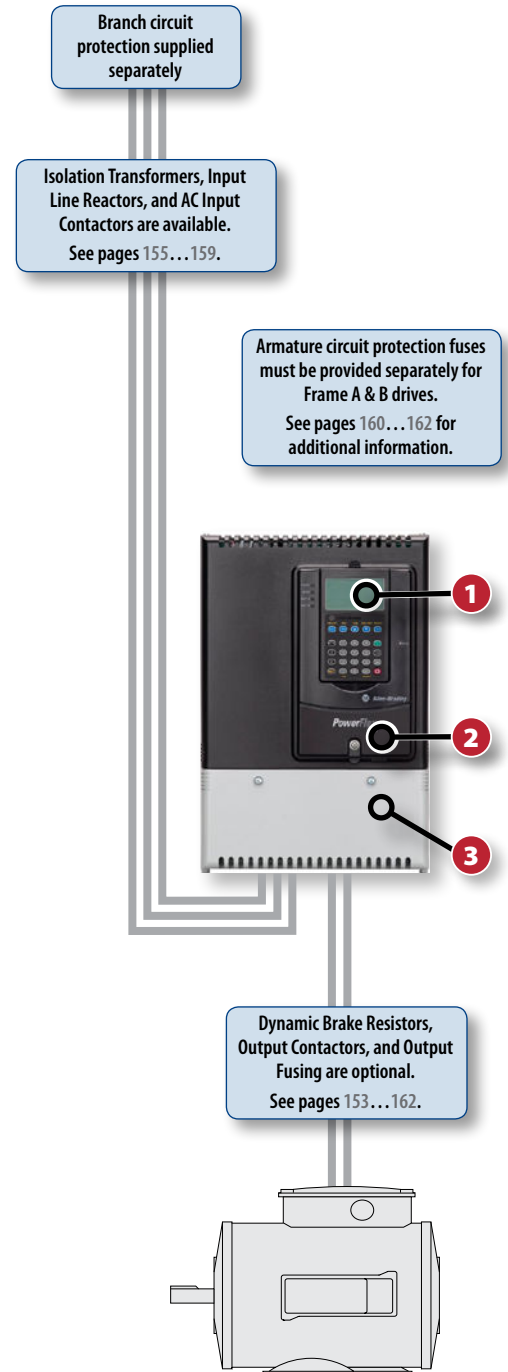

- 1** LCD Numeric HIM shown (optional). See page 152 for other options.
- 2** Multiple Communications options for industrial networks are available. See page 152.
- 3** Embedded I/O: 8 digital inputs, 4 digital outputs, 3 analog inputs, 2 analog outputs, and 2 relay outputs. See page 152 for other options.

Additional Information

PowerFlex Digital DC Drive Technical Data, publication [20P-TD001](#)

PowerFlex Digital DC Drive User Manual, publication [20P-UM001](#)

Catalog Number Explanation

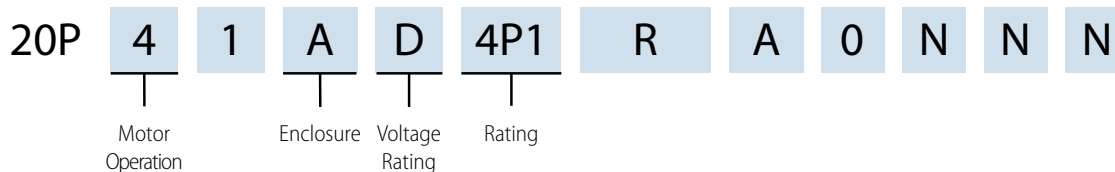

Product Selection

IP00/IP20, NEMA/UL Type Open

All drives are rated 150% overload for 60 seconds, 200% for 3 seconds.

200...240V AC, Three-Phase Drives

Drive Output Rating - 230V AC Input			Regenerative Drives Cat. No.	Frame Size
Normal Duty kW	Normal Duty Hp	Amps		
1.2	1.5	7	20P41AB7PORA0NNN	A
1.5	2	9	20P41AB9PORA0NNN	
2.2	3	12	20P41AB012RA0NNN	
3.7	5	20	20P41AB020RA0NNN	
5.5	7.5	29	20P41AB029RA0NNN	
7.5	10	38	20P41AB038RA0NNN	
11	15	55	20P41AB055RA0NNN	
15	20	73	20P41AB073RA0NNN	
18.5	25	93	20P41AB093RA0NNN	
22	30	110	20P41AB110RA0NNN	
30	40	146	20P41AB146RA0NNN	B
37	50	180	20P41AB180RA0NNN	
45	60	218	20P41AB218RA0NNN	
56	75	265	20P41AB265RA0NNN	
75	100	360	20P41AB360RA0NNN	
93	125	434	20P41AB434RA0NNN	C
112	150	521	20P41AB521RA0NNN	
149	200	700	20P41AB700RA0NNN	D
186	250	875	20P41AB875RA0NNN	
224	300	1050	20P41AB1K0RA0NNN	

380...480V AC, Three-Phase Drives

Drive Output Rating - 460V AC Input			Non-regenerative Drives	Regenerative Drives	Frame Size
Normal Duty kW	Normal Duty Hp	Amps	Cat. No.	Cat. No.	
1.5	2	4.1	20P21AD4P1RA0NNN	20P41AD4P1RA0NNN	A
2.2	3	6	20P21AD6P0RA0NNN	20P41AD6P0RA0NNN	
3.7	5	10	20P21AD010RA0NNN	20P41AD010RA0NNN	
5.5	7.5	14	20P21AD014RA0NNN	20P41AD014RA0NNN	
7.5	10	19	20P21AD019RA0NNN	20P41AD019RA0NNN	
11	15	27	20P21AD027RA0NNN	20P41AD027RA0NNN	
15	20	35	20P21AD035RA0NNN	20P41AD035RA0NNN	
18.5	25	45	20P21AD045RA0NNN	20P41AD045RA0NNN	
22	30	52	20P21AD052RA0NNN	20P41AD052RA0NNN	
30	40	73	20P21AD073RA0NNN	20P41AD073RA0NNN	
37	50	86	20P21AD086RA0NNN	20P41AD086RA0NNN	
45	60	100	20P21AD100RA0NNN	20P41AD100RA0NNN	
56	75	129	20P21AD129RA0NNN	20P41AD129RA0NNN	
75	100	167	20P21AD167RA0NNN	20P41AD167RA0NNN	B
93	125	207	20P21AD207RA0NNN	20P41AD207RA0NNN	
112	150	250	20P21AD250RA0NNN	20P41AD250RA0NNN	
149	200	330	20P21AD330RA0NNN	20P41AD330RA0NNN	
187	250	412	20P21AD412RA0NNN	20P41AD412RA0NNN	
224	300	495	20P21AD495RA0NNN	20P41AD495RA0NNN	C
298	400	667	20P21AD667RA0NNN	20P41AD667RA0NNN	
373	500	830	20P21AD830RA0NNN	20P41AD830RA0NNN	D
447	600	996	20P21AD996RA0NNN	20P41AD996RA0NNN	
552	700	1162	20P21AD1K1RA0NNN	20P41AD1K1RA0NNN	
597	800	1328	20P21AD1K3RA0NNN	20P41AD1K3RA0NNN	
671	900	1494	20P21AD1K4RA0NNN	20P41AD1K4RA0NNN	

500...600V AC, Three-Phase Drives

Drive Output Rating - 460V AC Input			Non-regenerative Drives Cat. No.	Regenerative Drives Cat. No.	Frame Size
Normal Duty kW	Normal Duty Hp	Amps			
37	50	67.5	20P21AE067RA0NNN	20P41AE067RA0NNN	B
56	75	101.3	20P21AE101RA0NNN	20P41AE101RA0NNN	
75	100	135	20P21AE135RA0NNN	20P41AE135RA0NNN	
149	200	270	20P21AE270RA0NNN	20P41AE270RA0NNN	
224	300	405	20P21AE405RA0NNN	20P41AE405RA0NNN	
298	400	540	20P21AE540RA0NNN	20P41AE540RA0NNN	C
373	500	675	20P21AE675RA0NNN	20P41AE675RA0NNN	
447	600	810	20P21AE810RA0NNN	20P41AE810RA0NNN	D
597	800	1080	20P21AE1K0RA0NNN	20P41AE1K0RA0NNN	
671	900	1215	20P21AE1K2RA0NNN	20P41AE1K2RA0NNN	
746	1000	1350	20P21AE1K3RA0NNN	20P41AE1K3RA0NNN	
932	1250	1688	20P21AE1K6RA0NNN	20P41AE1K6RA0NNN	

690V AC, Three-Phase Drives

Drive Output Rating - 460V AC Input			Non-regenerative Drives Cat. No.	Regenerative Drives Cat. No.	Frame Size
Normal Duty kW	Normal Duty Hp	Amps			
298	400	452	20P21AF452RA0NNN	20P41AF452RA0NNN	C
373	500	565	20P21AF565RA0NNN	20P41AF565RA0NNN	
447	600	678	20P21AF678RA0NNN	20P41AF678RA0NNN	D
552	700	791	20P21AF791RA0NNN	20P41AF791RA0NNN	
597	800	904	20P21AF904RA0NNN	20P41AF904RA0NNN	
671	900	1017	20P21AF1K0RA0NNN	20P41AF1K0RA0NNN	
746	1000	1130	20P21AF1K1RA0NNN	20P41AF1K1RA0NNN	
820	1100	1243	20P21AF1K2RA0NNN	20P41AF1K2RA0NNN	
932	1250	1413	20P21AF1K4RA0NNN	20P41AF1K4RA0NNN	
1044	1400	1582	20P21AF1K5RA0NNN	20P41AF1K5RA0NNN	

PowerFlex DC Drive Options



Blank Plate



20-HIM-A3



20-HIM-A5



20-HIM-A6



20-HIM-C3S



20-HIM-C5S



20-HIM-C6S

Human Interface Modules

Description	Cat. No.
No HIM (Blank Plate), Handheld/Local (Drive Mount)	20-HIM-A0
LCD Display, Full Numeric Keypad, Handheld/Local (Drive Mount)	20-HIM-A3
LCD Display, Programmer Only, Handheld/Local (Drive Mount)	20-HIM-A5
Enhanced, LCD, Full Numeric Keypad, Handheld/Local (Drive Mount)	20-HIM-A6
Remote (Panel Mount) LCD Display, Full Numeric Keypad ⁽¹⁾⁽²⁾	20-HIM-C3S
Remote (Panel Mount) LCD Display, Programmer Only ⁽¹⁾⁽²⁾	20-HIM-C5S
Enhanced, LCD, Full Numeric Keypad ⁽¹⁾⁽²⁾	20-HIM-C6S

(1) IP66, NEMA Type 4X/12—for indoor use only.

(2) Includes a 1202-C30 interface cable (3 m/9.8 ft) for connection to drive.

Human Interface Module (HIM) Accessories

Description	Cat. No.
Bezel Kit for LCD HIMs, NEMA Type 1 ⁽¹⁾	20-HIM-B1
PowerFlex HIM Interface Cable, 1 m (3.3 ft) ⁽²⁾	20-HIM-H10
Cable Kit (Male-Female) ⁽³⁾	
0.33 m (1.1 ft)	1202-H03
1 m (3.3 ft)	1202-H10
3 m (9.8 ft)	1202-H30
9 m (29.5 ft)	1202-H90
DPI/SCANport™ One to Two Port Splitter Cable	1203-S03

(1) Includes a 1202-C30 interface cable (3 m/9.8 ft) for connection to drive.

(2) Required only when HIM is used as handheld or remote.

(3) Required in addition to 20-HIM-H10 for distances up to a total maximum of 10 m (32.8 ft).

Communication Accessories

Description	Cat. No.
Universal Serial Bus™ (USB) Converter includes 2m USB, 20-HIM-H10 & 22-HIM-H10 Cables	1203-USB

Communication Option Kits

Description	Cat. No.
BACnet® MS/TP RS485 Communication Adapter	20-COMM-B
ControlNet™ Communication Adapter (Coax)	20-COMM-C
DeviceNet™ Communication Adapter	20-COMM-D
EtherNet/IP™ Communication Adapter	20-COMM-E
Dual port EtherNet/IP™ Communication Adapter	20-COMM-ER
HVAC Communication Adapter	20-COMM-H
Modbus/TCP Communication Adapter	20-COMM-M
PROFIBUS™ DP Communication Adapter	20-COMM-P
ControlNet™ Communication Adapter (Fiber)	20-COMM-Q
RS485 DF1 Communication Adapter	20-COMM-S
External Communications Kit Power Supply	20-XCOMM-AC-PS1
DPI External Communications Kit ⁽²⁾	20-XCOMM-DC-BASE
External DPI I/O Option Board	20-XCOMM-IO-OPT1
Compact I/O Module (3 Channel)	1769-SM1

(1) This item has Silver Series status. For information, refer to <http://www.rockwellautomation.com/global/solutions-services/capabilities/migration-solutions/product-search/overview.page>.

(2) For use only with DPI External Communications Kits 20-XCOMM-DC-BASE.

I/O Option Kits

Description	Cat. No.
I/O Expansion Board (4 - 24V DC Digital Inputs, 4 Digital Outputs, 2 Analog Outputs)	20P-SSV62
115V AC to 24V DC 8 Channel I/O Converter Board (converts 8 Digital Inputs)	20P-SS20L

Feedback Options

Description	Cat. No.
Resolver Feedback Option Module	20P-RES-A0

Dynamic Brake Resistors Kits and DC Output Contactors - 230V AC Input Drives

Frame	Drive Current Rating Code	DC Amps	AC Line Amps	Hp	Dynamic Brake Resistor Kit Cat. No.	Armature Voltage	Total DB Resistance	DC Loop Contactor Cat. No. ⁽²⁾		DC Contactor Crimp Lugs ⁽³⁾ Cat. No.
						Volts	Ohms	Drive without Dynamic Brake	Drive with Dynamic Brake	
A	7P0	7	5.7	1.5	1370-DBL62	240	20	1370-NC56	1370-DC56	1370-LG40
	9P0	9	7.4	2	1370-DBL63	240	20	1370-NC56	1370-DC56	1370-LG40
	012	12	9.8	3	1370-DBL64	240	15	1370-NC56	1370-DC56	1370-LG40
	020	20	16	5	1370-DBL65	240	8.6	1370-NC56	1370-DC56	1370-LG40
	029	29	24	7.5	1370-DBL66	240	6	1370-NC56	1370-DC56	1370-LG40
	038	38	31	10	1370-DBL67	240	5	1370-NC56	1370-DC56	1370-LG40
	055	55	45	15	1370-DBL68	240	3.5	1370-NC56	1370-DC56	1370-LG56
	073	73	60	20	1370-DBL69	240	2.6	1370-NC110	1370-DC110	1370-LG92
	093	93	76	25	1370-DBL70	240	2	1370-NC110	1370-DC110	1370-LG92
	110	110	90	30	1370-DBL71	240	2	1370-NC110	1370-DC110	1370-LG110
B	146	146	119	40	1370-DBL72	240	1.4	1370-NC180	1370-DC180	1370-LG160
	180	180	147	50	1370-DBL73	240	1.0	1370-NC180	1370-DC180	1370-LG180
	218	218	178	60	1370-DBL74	240	1.0	1370-NC280	1370-DC280	1370-LG228
	265	265	217	75	1370-DBL75	240	0.67	1370-NC280	1370-DC280	1370-LG268
	360	360	294	100	1370-DBL76	240	0.47	(1)	(1)	(4)
	434	434	355	125	(1)	240	0.4	(1)	(1)	(4)
C	521	521	426	150	(1)	240	0.322	(1)	(1)	(4)
	700	700	572	200	(1)	240	0.25	(1)	(1)	(4)
D	875	875	715	250	(1)	240	0.2	(1)	(1)	(4)
	1K0	1050	858	300	(1)	240	0.2	(1)	(1)	(4)

(1) No dynamic brake resistor kit is available for this drive rating—must be sourced locally.

(2) Coil voltage equals 115V AC, 50/60 Hz.

(3) For more information, see the DC Contactor Crimp Lug Kit Specifications in the PowerFlex Digital DC Drive Technical Data, publication [20P-TD001](#).

(4) Wire and lug size are dependent on enclosure dimensions and local codes.

Dynamic Brake Resistors Kits and DC Output Contactors - 460V AC Input Drives

Frame	Drive Current Rating Code	DC Amps	AC Line Amps	Hp	Dynamic Brake Resistor Kit Cat. No.	Armature Voltage	Total DB Resistance	DC Loop Contactor Cat. No. ⁽²⁾		DC Contactor Crimp Lugs ⁽³⁾ Cat. No.
						Volts	Ohms	Drive without Dynamic Brake	Drive with Dynamic Brake	
A	4P1	4.1	3.3	2	1370-DBH63	500	81	1370-NC56	1370-DC56	1370-LG40
	6P0	6	4.9	3	1370-DBH64	500	62	1370-NC56	1370-DC56	1370-LG40
	010	10	8.2	5	1370-DBH65	500	45	1370-NC56	1370-DC56	1370-LG40
	014	14	11.4	7.5	1370-DBH66	500	27	1370-NC56	1370-DC56	1370-LG40
	019	19	15.5	10	1370-DBH67	500	20	1370-NC56	1370-DC56	1370-LG40
	027	27	22.1	15	1370-DBH68	500	12	1370-NC56	1370-DC56	1370-LG40
	035	35	28.6	20	1370-DBH69	500	10	1370-NC56	1370-DC56	1370-LG40
	045	45	36.8	25	1370-DBH70	500	9	1370-NC56	1370-DC56	1370-LG52
	052	52	42.5	30	1370-DBH71	500	7	1370-NC56	1370-DC56	1370-LG52
	073	73	59.6	40	1370-DBH72	500	5.2	1370-NC110	1370-DC110	1370-LG92
	086	86	70.3	50	1370-DBH73	500	4	1370-NC110	1370-DC110	1370-LG92
	100	100	81.7	60	1370-DBH74	500	4	1370-NC110	1370-DC110	1370-LG110
	129	129	105.4	75	1370-DBH75	500	3	1370-NC180	1370-DC180	1370-LG140
B	167	167	136.4	100	1370-DBH76	500	2.1	1370-NC180	1370-DC180	1370-LG180
	207	207	169.1	125	1370-DBH77	500	2.1	1370-NC280	1370-DC280	1370-LG228
	250	250	204.3	150	1370-DBH78	500	1.5	1370-NC280	1370-DC280	1370-LG268
	330	330	269.6	200	1370-DBH79	500	1.05	(1)	(1)	(4)
	412	412	336.6	250	(1)	500	1	(1)	(1)	(4)
C	495	495	404.4	300	(1)	500	0.8	(1)	(1)	(4)
	667	667	544.9	400	(1)	500	0.625	(1)	(1)	(4)
D	800	830	678.1	500	(1)	500	0.463	(1)	(1)	(4)
	960	996	813.7	600	(1)	500	0.322	(1)	(1)	(4)
	1K1	1162	949.4	700	(1)	500	0.322	(1)	(1)	(4)
	1K3	1328	1085.0	800	(1)	500	0.255	(1)	(1)	(4)
	1K4	1494	1220.6	900	(1)	500	0.255	(1)	(1)	(4)

- (1) No dynamic brake resistor kit is available for this drive rating—must be sourced locally.
- (2) Coil voltage equals 115V AC, 50/60 Hz.
- (3) For more information, see the DC Contactor Crimp Lug Kit Specifications in the PowerFlex Digital DC Drive Technical Data, publication [20P-TD001](#).
- (4) Wire and lug size are dependent on enclosure dimensions and local codes.

AC Input Line Reactors and Contactors - 230V AC Input Drives

An AC contactor is not required if a DC contactor is used in the armature circuit.

Drive Cat. No.	DC Amps	AC Line Amps	Hp	IP00 (Open Style) Line Reactor Cat. No.	Line Reactor kW (Hp)	AC Input Contactor Cat. No.
Regenerative						
20P41AB7PORA0NNN	7	5.7	1.5	1321-3R8-A	0.75 (1)	100-C12D10
20P41AB9PORA0NNN	9	7.4	2	1321-3R12-A	1.49 (2)	100-C12D10
20P41AB012RA0NNN	12	9.8	3	1321-3R18-A	0.75...3.7 (1...5)	100-C12D10
20P41AB020RA0NNN	20	16	5	1321-3R18-A	0.75...3.7 (1...5)	100-C23D10
20P41AB029RA0NNN	29	24	7.5	1321-3R55-A	5.5...11 (7.5...15)	100-C30D10
20P41AB038RA0NNN	38	31	10	1321-3R55-A	5.5...11 (7.5...15)	100-C37D10
20P41AB055RA0NNN	55	45	15	1321-3R55-A	5.5...11 (7.5...15)	100-C60D10
20P41AB073RA0NNN	73	60	20	1321-3R80-A	15 (20)	100-C60D10
20P41AB093RA0NNN	93	76	25	1321-3R100-A	18.5...22 (25...30)	100-C85D10
20P41AB110RA0NNN	110	90	30	1321-3R100-A	18.5...22 (25...30)	100-D110D11
20P41AB146RA0NNN	146	119	40	1321-3R160-A	30...37 (40...50)	100-D140D11
20P41AB180RA0NNN	180	147	50	1321-3R160-A	30...37 (40...50)	100-D180D11
20P41AB218RA0NNN	218	178	60	1321-3RB250-A	45...56 (60...75)	100-D180D11
20P41AB265RA0NNN	265	217	75	1321-3RB250-A	45...56 (60...75)	100-D250ED11
20P41AB360RA0NNN	360	294	100	1321-3RB320-A	75 (100)	100-D300ED11
20P41AB434RA0NNN	434	355	125	1321-3RB400-A	93 (125)	100-D420ED11
20P41AB521RA0NNN	521	426	150	1321-3R500-A	112 (150)	100-D630ED11
20P41AB700RA0NNN	700	572	200	1321-3R600-A	149 (200)	100-D630ED11
20P41AB875RA0NNN	875	715	250	1321-3R750-A	186 (250)	100-D860ED11
20P41AB1K0RA0NNN	1050	858	300	1321-3R850-A	224 (300)	100-D860ED11

AC Input Line Reactors and Contactors - 460V AC Input Drives

Drive Cat. No.		DC Amps	AC Line Amps	Hp	IP00 (Open Style) Line Reactor Cat. No.	Line Reactor kW (Hp)	AC Input Contactor Cat. No.
Non-Regenerative	Regenerative						
20P21AD4P1RAONNN	20P41AD4P1RAONNN	4.1	3.3	2	1321-3R4-A	0.55 (0.75)	100-C12D10
20P21AD6P0RAONNN	20P41AD6P0RAONNN	6	4.9	3	1321-3R8-A	0.75 (1)	100-C12D10
20P21AD010RAONNN	20P41AD010RAONNN	10	8.2	5	1321-3R18-B	1.5...7.5 (2...10)	100-C12D10
20P21AD014RAONNN	20P41AD014RAONNN	14	11.4	7.5	1321-3R18-B	1.5...7.5 (2...10)	100-C12D10
20P21AD019RAONNN	20P41AD019RAONNN	19	15.5	10	1321-3R18-B	1.5...7.5 (2...10)	100-C23D10
20P21AD027RAONNN	20P41AD027RAONNN	27	22.1	15	1321-3R55-B	11...22 (15...30)	100-C23D10
20P21AD035RAONNN	20P41AD035RAONNN	35	28.6	20	1321-3R55-B	11...22 (15...30)	100-C30D10
20P21AD045RAONNN	20P41AD045RAONNN	45	36.8	25	1321-3R55-B	11...22 (15...30)	100-C37D10
20P21AD052RAONNN	20P41AD052RAONNN	52	42.5	30	1321-3R55-B	11...22 (15...30)	100-C43D10
20P21AD073RAONNN	20P41AD073RAONNN	73	59.6	40	1321-3R80-B	30 (40)	100-C60D10
20P21AD086RAONNN	20P41AD086RAONNN	86	70.3	50	1321-3R100-B	37...45 (50...60)	100-C85D10
20P21AD100RAONNN	20P41AD100RAONNN	100	81.7	60	1321-3R100-B	37...45 (50...60)	100-C85D10
20P21AD129RAONNN	20P41AD129RAONNN	129	105.4	75	1321-3R160-B	56...75 (75...100)	100-D110D11
20P21AD167RAONNN	20P41AD167RAONNN	167	136.4	100	1321-3R160-B	56...75 (75...100)	100-D140D11
20P21AD207RAONNN	20P41AD207RAONNN	207	169.1	125	1321-3RB250-B	93...112 (125...150)	100-D180D11
20P21AD250RAONNN	20P41AD250RAONNN	250	204.3	150	1321-3RB250-B	93...112 (125...150)	100-D210ED11
20P21AD330RAONNN	20P41AD330RAONNN	330	269.6	200	1321-3RB320-B	149 (200)	100-D300ED11
20P21AD412RAONNN	20P41AD412RAONNN	412	336.6	250	1321-3RB400-B	186.4 (250)	100-D420ED11
20P21AD495RAONNN	20P41AD495RAONNN	495	404.4	300	1321-3R500-B	223.7 (300)	100-D420ED11
20P21AD667RAONNN	20P41AD667RAONNN	667	544.9	400	1321-3R600-B	298.3 (400)	100-D630ED11
20P21AD830RAONNN	20P41AD830RAONNN	830	678.1	500	1321-3R750-B	372.8 (500)	100-D860ED11
20P21AD996RAONNN	20P41AD996RAONNN	996	813.7	600	1321-3R850-B	447.4 (600)	100-D860ED11
20P21AD1K1RAONNN	20P41AD1K1RAONNN	1162	949.4	700	1321-3R1000-B	552 (700)	100-G860KD22
20P21AD1K3RAONNN	20P41AD1K3RAONNN	1328	1085.0	800	2 x1321-3R600-B	596.6 (800)	100-G860KD22
20P21AD1K4RAONNN	20P41AD1K4RAONNN	1494	1220.6	900	2 x1321-3R600-B	671.1 (900)	100-G1200KD12

AC Input Line Reactors and Contactors - 575V AC Input Drives

Drive Cat. No.		DC Amps	AC Line Amps	Hp	IP00 (Open Style) Line Reactor Cat. No.	Line Reactor kW (Hp)	AC Input Contactor Cat. No.
Non-Regenerative	Regenerative						
20P21AE067RA0NNN	20P41AE067RA0NNN	67.5	55.1	50	1321-3R55-B	37 (50)	100-C60D10
20P21AE101RA0NNN	20P41AE101RA0NNN	101.25	82.7	75	1321-3R100-B	56 (75)	100-C85D10
20P21AE135RA0NNN	20P41AE135RA0NNN	135	110.3	100	1321-3R130-B	75 (100)	100-D110D11
20P21AE270RA0NNN	20P41AE270RA0NNN	270	220.6	200	1321-3RB250-B	149 (200)	100-D250ED11
20P21AE405RA0NNN	20P41AE405RA0NNN	405	330.9	300	1321-3RB320-B	224 (300)	100-D420ED11
20P21AE540RA0NNN	20P41AE540RA0NNN	540	441.2	400	1321-3RB500-B	298 (400)	100-D630ED11
20P21AE675RA0NNN	20P41AE675RA0NNN	675	551.5	500	1321-3R600-B	373 (500)	100-D630ED11
20P21AE810RA0NNN	20P41AE810RA0NNN	810	661.8	600	1321-3R750-B	447 (600)	100-D860ED11
20P21AE1K0RA0NNN	20P41AE1K0RA0NNN	1080	882.4	800	1321-3R1000-B	597 (800)	100-G700KD22
20P21AE1K2RA0NNN	20P41AE1K2RA0NNN	1215	992.7	900	1321-3R1000-B	671 (900)	100-G860KD22
20P21AE1K3RA0NNN	20P41AE1K3RA0NNN	1350	1103.0	1000	2 x 1321-3R600-B	746 (1000)	100-G1000KD12
20P21AE1K6RA0NNN	20P41AE1K6RA0NNN	1687.5	1378.7	1250	2 X 1321-3R750-B	—	(1)

(1) No AC input contactor is available for this drive rating—must be sourced locally.

AC Input Line Reactors and Contactors - 690V AC Input Drives

Drive Cat. No.		DC Amps	AC Line Amps	Hp	IP00 (Open Style) Line Reactor Cat. No.	Line Reactor kW (Hp)	AC Input Contactor Cat. No.
Non-Regenerative	Regenerative						
20P21AF452RA0NNN	20P41AF452RA0NNN	452	369	400	1321-3RB500-C	—	100-D420ED11
20P21AF565RA0NNN	20P41AF565RA0NNN	565	462	500	1321-3RB600-C		100-D630ED11
20P21AF678RA0NNN	20P41AF678RA0NNN	678	554	600	1321-3R750-C		100-D630ED11
20P21AF791RA0NNN	20P41AF791RA0NNN	791	646	700	1321-3R750-C		100-D860ED11
20P21AF904RA0NNN	20P41AF904RA0NNN	904	739	800	1321-3R1000-C		100-D860ED11
20P21AF1K0RA0NNN	20P41AF1K0RA0NNN	1017	831	900	1321-3R1000-C		100-D860ED11
20P21AF1K1RA0NNN	20P41AF1K1RA0NNN	1130	923	1000	2 X 1321-3R600-C		100-G700KD22
20P21AF1K2RA0NNN	20P41AF1K2RA0NNN	1243	1016	1100	2 X 1321-3R600-C		100-G860KD22
20P21AF1K4RA0NNN	20P41AF1K4RA0NNN	1412.5	1154	1250	2 X 1321-3R750-C		100-G1200KD12
20P21AF1K5RA0NNN	20P41AF1K5RA0NNN	1582	1292	1400	2 X 1321-3R750-C		100-G1200KD12

Isolation Transformers - IP32, NEMA / UL Type 3R Standalone, 4...6% Nominal Impedance

Isolation transformers are available for installations that have specific types of AC supply configurations or require drive protection due to AC line disturbances.

Three-Phase Primary			Three-Phase Secondary		
kVA	Kw (Hp)	Voltage	230V Secondary Cat. No.	460V Secondary Cat. No.	575V Secondary Cat. No.
5	1.2...2.2 (1.5...3)	230	1321-3TW005-AA	1321-3TW005-AB	—
		460	1321-3TW005-BA	1321-3TW005-BB	
		575	1321-3TW005-CA	1321-3TW005-CB	
40	22 (30)	230	1321-3TW040-AA	1321-3TW040-AB	
		460	1321-3TW040-BA	1321-3TW040-BB	
		575	1321-3TW040-CA	1321-3TW040-CB	
51	30 (40)	230	1321-3TW051-AA	1321-3TW051-AB	
		460	1321-3TW051-BA	1321-3TW051-BB	
		575	1321-3TW051-CA	1321-3TW051-CB	
63	37 (50)	230	1321-3TH063-AA	1321-3TH063-AB	1321-3TH063-AC
		460	1321-3TH063-BA	1321-3TH063-BB	1321-3TH063-BC
		575	1321-3TH063-CA	1321-3TH063-CB	1321-3TH063-CC
75	45 (60)	230	1321-3TH075-AA	1321-3TH075-AB	1321-3TH075-AC
		460	1321-3TH075-BA	1321-3TH075-BB	1321-3TH075-BC
		575	1321-3TH075-CA	1321-3TH075-CB	1321-3TH075-CC
93	56 (75)	230	1321-3TH093-AA	1321-3TH093-AB	1321-3TH093-AC
		460	1321-3TH093-BA	1321-3TH093-BB	1321-3TH093-BC
		575	1321-3TH093-CA	1321-3TH093-CB	1321-3TH093-CC
118	75 (100)	230	1321-3TH118-AA	1321-3TH118-AB	1321-3TH118-AC
		460	1321-3TH118-BA	1321-3TH118-BB	1321-3TH118-BC
		575	1321-3TH118-CA	1321-3TH118-CB	1321-3TH118-CC
145	93 (125)	230	1321-3TH145-AA	1321-3TH145-AB	1321-3TH145-AC
		460	1321-3TH145-BA	1321-3TH145-BB	1321-3TH145-BC
		575	1321-3TH145-CA	1321-3TH145-CB	1321-3TH145-CC
175	112 (150)	230	1321-3TH175-AA	1321-3TH175-AB	1321-3TH175-AC
		460	1321-3TH175-BA	1321-3TH175-BB	1321-3TH175-BC
		575	1321-3TH175-CA	1321-3TH175-CB	1321-3TH175-CC
220	145 (200)	230	1321-3TH220-AA	1321-3TH220-AB	1321-3TH220-AC
		460	1321-3TH220-BA	1321-3TH220-BB	1321-3TH220-BC
		575	1321-3TH220-CA	1321-3TH220-CB	1321-3TH220-CC
275	187 (250)	230	1321-3TH275-AA	1321-3TH275-AB	1321-3TH275-AC
		460	1321-3TH275-BA	1321-3TH275-BB	1321-3TH275-BC
		575	1321-3TH275-CA	1321-3TH275-CB	1321-3TH275-CC
330	224 (300)	230	1321-3TH330-AA	1321-3TH330-AB	1321-3TH330-AC
		460	1321-3TH330-BA	1321-3TH330-BB	1321-3TH330-BC
		575	1321-3TH330-CA	1321-3TH330-CB	1321-3TH330-CC

(table continues on next page)

Isolation Transformers - IP32, NEMA / UL Type 3R Standalone, 4...6% Nominal Impedance (continued)

Three-Phase Primary			Three-Phase Secondary		
kVA	Kw (Hp)	Voltage	230V Secondary Cat. No.	460V Secondary Cat. No.	575V Secondary Cat. No.
440	298 (400)	230	—	1321-3TH440-AB	1321-3TH440-AC
		460		1321-3TH440-BB	1321-3TH440-BC
		575		1321-3TH440-CB	1321-3TH440-CC
550	373 (500)	230		1321-3TH550-AB	1321-3TH550-AC
		460		1321-3TH550-BB	1321-3TH550-BC
		575		1321-3TH550-CB	1321-3TH550-CC
660	448 (600)	230		1321-3TH660-AB	1321-3TH660-AC
		460		1321-3TH660-BB	1321-3TH660-BC
		575		1321-3TH660-CB	1321-3TH660-CC
770	522 (700)	230		1321-3TH770-AB	1321-3TH770-AC
		460		1321-3TH770-BB	1321-3TH770-BC
		575		1321-3TH770-CB	1321-3TH770-CC
880	597 (800)	230	1321-3TH880-AB	1321-3TH880-AC	
		460	1321-3TH880-BB	1321-3TH880-BC	
		575	1321-3TH880-CB	1321-3TH880-CC	

Frame D Terminal Adapter Kits

The following frame D drives require the listed terminal adapter kits in order to meet UL installation requirements.

Voltage Class	Drive Current Rating Code	U, V, W Terminal Adapter Kit	C, D Terminal Adapter Kit
230	1K0	SK-20P-S726172	—
460	1K1	SK-20P-S726171	
	1K3		
	1K4		
575	1K0	SK-20P-S726172	SK-20P-S726173
	1K2	SK-20P-S726171	
	1K3		
690	1K6		
	1K0	SK-20P-S726172	—
	1K1	SK-20P-S726171	
	1K2		
	1K4		
1K5			

Frame A and Frame B AC Input Line Fuses - 230V AC Input Drives

Frame	Drive Current Rating Code	DC Amps	AC Line Amps	Bussmann		Mersen	
				Ferrule FWP Type	North American FWP Type	Ferrule A70QS Type	North American A70P/A70QS Type
A	7P0	7	5.7	FWP-10A14F	FWP-10B	A70QS10-14F	A70P10-4
	9P0	9	7.4	FWP-15A14F	FWP-15B	A70QS16-14F	A70P15-4
	012	12	9.8	FWP-20A14F	FWP-20B	A70QS20-14F	A70P20-4
	020	20	16	FWP-25A14F	FWP-25B	A70QS25-14F	A70P25-4
	029	29	24	FWP-40A22F	FWP-40B	A70QS40-22F	A70QS40-4
	038	38	31	FWP-63A22F	FWP-60B	A70QS63-22F	A70QS60-4
	055	55	45	FWP-80A22F	FWP-80B	A70QS80-22F	A70QS80-4
	073	73	60	—	FWP-100A	—	A70QS100-4K
	093	93	76		FWP-150A		A70QS150-4K
	110	110	90		FWP-175A		A70QS175-4K
B	146	146	119		FWP-250A		A70QS250-4
	180	180	147		FWP-300A		A70QS300-4
	218	218	178		FWP-350A		A70QS350-4
	265	265	217	FWP-400A	A70QS400-4		
	360	360	294	FWP-600A	A70QS600-4K		
434	434	355	FWP-600A	A70QS600-4			

Frame A and Frame B AC Input Line Fuses - 460V AC Input Drives

Frame	Drive Current Rating Code	DC Amps	AC Line Amps	Bussmann		Mersen		
				Ferrule FWP Type	North American FWP Type	Ferrule A70QS Type	North American A70P/A70QS Type	
A	4P1	4.1	3.3	FWP-10A14F	FWP-10B	A70QS10-14F	A70P10-4	
	6P0	6	4.9	FWP-10A14F	FWP-10B	A70QS10-14F	A70P10-4	
	010	10	8.2	FWP-20A14F	FWP-20B	A70QS20-14F	A70P25-4	
	014	14	11.4	FWP-25A14F	FWP-25B	A70QS25-14F	A70P25-4	
	019	19	15.5	FWP-25A14F	FWP-25B	A70QS25-14F	A70P25-4	
	027	27	22.1	FWP-40A22F	FWP-40B	A70QS40-22F	A70QS40-4	
	035	35	28.6	FWP-63A22F	FWP-60B	A70QS63-22F	A70QS60-4	
	045	45	36.8	FWP-80A22F	FWP-80B	A70QS80-22F	A70QS80-4	
	052	52	42.5	FWP-80A22F	FWP-80B	A70QS80-22F	A70QS80-4	
	073	73	59.6	—	FWP-100A	—	A70QS100-4K	
	086	86	70.3		FWP-150A		A70QS150-4K	
	100	100	81.7		FWP-175A		A70QS175-4K	
	129	129	105.4		FWP-175A		A70QS175-4K	
	B	167	167		136.4		FWP-300A	A70QS300-4
		207	207		169.1		FWP-350A	A70QS350-4
250		250	204.3	FWP-400A	A70QS400-4			
330		330	269.6	FWP-600A	A70QS600-4K			
412		412	336.6	FWP-600A	A70QS600-4			

Frame B AC Input Line Fuses - 575V AC Input Drives

Frame	Drive Current Rating Code	DC Amps	AC Line Amps	Bussmann		Mersen	
				Ferrule FWP Type	North American FWP Type	Ferrule A70QS Type	North American A70P/A70QS Type
B	067	67.5	55.1	—	FWP-100A	—	A70QS100-4
	101	101.3	82.7		FWP-175A		A70QS175-4K
	135	135	110.3		FWP-225A		A70QS225-4
	270	270	220.6		FWP-450A		A70QS450-4
	405	405	330.9		FWP-600A		A70QS600-4K

Frame A and Frame B Armature DC Output Fuses - 230V AC Input Drives

Frame	Drive Current Rating Code	DC Amps	AC Line Amps	Bussmann		Mersen	
				Ferrule FWP Type	North American FWP Type	Ferrule A70QS Type	North American A70P/A70QS Type
A	7P0	7	5.7	FWP-15A14F	FWP-15B	A70QS16-14F	A70P15-4
	9P0	9	7.4	FWP-20A14F	FWP-20B	A70QS20-14F	A70P20-4
	012	12	9.8	FWP-25A14F	FWP-25B	A70QS25-14F	A70P25-4
	020	20	16	FWP-40A14F	FWP-40B	A70QS40-14F	A70QS40-4
	029	29	24	FWP-63A22F	FWP-60B	A70QS63-22F	A70QS60-4
	038	38	31	FWP-80A22F	FWP-80B	A70QS80-22F	A70QS80-4
	055	55	45	—	FWP-125A	—	A70QS125-4K
	073	73	60		FWP-150A		A70QS150-4K
	093	93	76		FWP-200A		A70QS200-4K
	110	110	90		FWP-225A		A70QS250-4
B	146	146	119	—	FWP-300A	—	A70QS300-4
	180	180	147		FWP-350A		A70QS350-4
	218	218	178		FWP-450A		A70QS450-4
	265	265	217		FWP-600A		A70QS600-4K
	360	360	294		FWP-700A		A70QS700-4
	434	434	355		FWP-900A		A70P900-4

Frame A and Frame B Armature DC Output Fuses - 460V AC Input Drives

Frame	Drive Current Rating Code	DC Amps	AC Line Amps	Bussmann		Mersen	
				Ferrule FWP Type	North American FWP Type	Ferrule A70QS Type	North American A70P/A70QS Type
A	4P1	4.1	3.3	FWP-10A14F	FWP-10B	A70QS10-14F	A70P10-4
	6P0	6	4.9	FWP-15A14F	FWP-15B	A70QS16-14F	A70P15-4
	010	10	8.2	FWP-20A14F	FWP-20B	A70QS20-14F	A70P20-4
	014	14	11.4	FWP-30A14F	FWP-30B	A70QS32-14F	A70P30-4
	019	19	15.5	FWP-40A14F	FWP-40B	A70QS40-14F	A70QS40-4
	027	27	22.1	FWP-63A22F	FWP-60B	A70QS63-22F	A70QS60-4
	035	35	28.6	FWP-80A22F	FWP-70B	A70QS80-22F	A70QS70-4
	045	45	36.8	FWP-100A22F	FWP-90B	—	A70QS90-4
	052	52	42.5	FWP-100A22F	FWP-100B		A70QS100-4
	073	73	59.6	—	FWP-150A		A70QS150-4K
	086	86	70.3	—	FWP-175A		A70QS175-4K
	100	100	81.7	—	FWP-200A		A70QS200-4K
	129	129	105.4	—	FWP-250A		A70QS250-4
B	167	167	136.4	—	FWP-350A		A70QS350-4
	207	207	169.1	—	FWP-400A		A70QS400-4
	250	250	204.3	—	FWP-500A		A70QS500-4K
	330	330	269.6	—	FWP-700A		A70QS700-4
	412	412	336.6	—	FWP-800A	A70QS800-4	

Frame B Armature DC Output Fuses - 575V AC Input Drives

Frame	Drive Current Rating Code	DC Amps	AC Line Amps	Bussmann		Mersen	
				Ferrule FWP Type	North American FWP Type	Ferrule A70QS Type	North American A70P/A70QS Type
B	067	67.5	55.1	FWP-125A	A70QS125-4K	—	A70QS100-4
	101	101.3	82.7	FWP-200A	A70QS200-4K		A70QS175-4K
	135	135	110.3	FWP-250A	A70QS250-4		A70QS225-4
	270	270	220.6	FWP-600A	A70QS600-4K		A70QS450-4
	405	405	330.9	FWP-800A	A70QS800-4		A70QS600-4K

Notes

PowerFlex AC Drives

	PowerFlex 4M AC Drive	PowerFlex 400 AC Drive
Motor Control	• Volts per Hertz	• Volts per Hertz
Application	• Open loop speed regulation	• Open loop speed regulation
Ratings 100-115V 1 Phase In/3 Phase 230V Out	• 0.2...1.1 kW • 0.25...1.5 Hp • 1.6...6 A	• N/A
Ratings 200-240V	• 0.2...7.5 kW • 0.25...10 Hp • 1.6...33 A	• 2.2...37 kW • 3.0...50 Hp • 12...145 A
Ratings 400-480V	• 0.4...11 kW • 0.5...15 Hp • 1.5...24 A	• 2.2...250 kW • 3.0...350 Hp • 6...460 A
Ratings 500-600V	• N/A	• N/A
Ambient Temperature* Limit for Enclosure Types	• IP20: -10 to 50 °C (14 to 122 °F) • IP20 zero stacking: -10 to 40 °C (14 to 104 °F)	• IP20, NEMA/UL Type Open, Frame C: -10 to 50 °C (14 to 122 °F) • IP20, NEMA/UL Type Open, Frame D and up: -10 to 45 °C (14 to 113 °F) • IP30, NEMA/UL Type Open, all frames: -10 to 45 °C (14 to 113 °F)
EMC Filters	• Internal (1 phase 240V and 3 phase 480V) • External (1 & 3 phase)	• External
Standards and Certifications	• c-UL-us, CE, RCM, RoHS, KCC, EAC, REACH	• c-UL-us, CE, RCM, RoHS, KCC, EAC, REACH
Overload Capability	• 150% for 60 s • 200% for 3 s	• 110% for 60 s
Output Frequency Range	• 0...400 Hz	• 0...320 Hz
User Interface	• Local keypad • Remote keypad • Studio 5000 Software • Connected Components Workbench Software	• Local keypad • Remote keypad • Studio 5000 Software • Connected Components Workbench Software
Communications Options	• Integral RS485 (Modbus RTU) • Optional: *EtherNet/IP, *ControlNet, *DeviceNet, *Bluetooth®, *LonWorks®, *PROFIBUS DP *Optional network for use only with DSI External Communications Kit	• Integral RS485 (Modbus RTU, Metasys N2, P1-FLN) • Optional: *EtherNet/IP, *ControlNet, *DeviceNet, BACnet, *Bluetooth®, *LonWorks®, *PROFIBUS DP
Analog Inputs	• Qty. 1 (unipolar voltage)	• Qty. 2 (1 bipolar voltage or current, 1 unipolar voltage or current)
Analog Outputs	• None	• Qty. 2 (unipolar voltage or current)
PTC Inputs	• Qty. 1 (uses an analog input)	• Qty. 1 (uses an analog input)
Digital Inputs	• Qty. 5 (24V DC, 2 programmable)	• Qty. 7 (24V DC, 4 programmable)
Relay Outputs	• Qty. 1 (form C)	• Qty. 2 (form C)
Transistor Outputs	• None	• Qty. 1
Dynamic Braking	• Internal IGBT except catalog numbers ending in "3"	• No
Safety	• No	• No
Found on Page	• 21	• 24

* Environmental considerations may apply

PowerFlex 523 AC Drive

- Volts per Hertz
- Sensorless vector control

- Open loop speed regulation

• 0.2...1.1 kW • 0.25...1.5 Hp • 1.6...6 A

• 0.2...15 kW • 0.25...20 Hp • 1.6...62.1 A

• 0.4...22 kW • 0.5...30 Hp • 1.4...43 A

• 0.4...22 kW • 0.5...30 Hp • 0.9...32 A

- IP20: -20 to 50 °C (-4 to 122 °F)
- IP20 Zero Stacking: -20* to 45 °C (-4 to 113 °F)
- IP20: -20 to 60 °C (140 °F), with current derating
- IP20: -20 to 70 °C (158 °F) with current derating and optional control module fan kit

- Internal (1 phase 240V and 3 phase 480V)
- External (1 & 3 phase)

- AC-156, c-UL-us, CE, RCM, RoHS, KCC, EAC, REACH, SEMI F47

- Normal duty application: 110% - 60 s, 150% - 3 s (For 20 Hp & above)
- Heavy duty application: 150% - 60 s, 180% - 3 s (200% - 3 secs programmable)

- 0...500 Hz

- 5 Digits, 16 segments QuickView™ LCD display with multiple languages and local keypad • Remote keypad
- MainsFree™ programming via USB • Application specific parameter group AppView™ and CustomView™
- Studio 5000 • Connected Components Workbench (CCW)

- Integral RS485 (Modbus RTU)
- Optional: Dual-port EtherNet/IP, DeviceNet, PROFIBUS DP

- Qty. 1 (unipolar voltage or current)

- Qty. 1 (unipolar voltage or current)

- Qty. 1 (uses an analog input)

- Qty. 5 (24V DC, 4 programmable)

- Qty. 1 (form C)

- None

- Internal IGBT

- No

- 37

PowerFlex 525 AC Drive

- Volts per Hertz • Sensorless vector control
- Closed loop velocity vector control
- Permanent magnet motor control

- Open loop speed regulation
- Closed loop speed regulation

• 0.4...1.1 kW • 0.5...1.5 Hp • 2.5...6 A

• 0.4...15 kW • 0.5...20 Hp • 2.5...62.1 A

• 0.4...22 kW • 0.5...30 Hp • 1.4...43 A

• 0.4...22 kW • 0.5...30 Hp • 0.9...32 A

- IP20: -20 to 50 °C (-4 to 122 °F)
- IP20 Zero Stacking: -20* to 45 °C (-4 to 113 °F)
- IP20: -20 to 60 °C (140 °F), with current derating
- IP20: -20 to 70 °C (158 °F) with current derating and optional control module fan kit

- Internal (1 phase 240V and 3 phase 480V)
- External (1 & 3 phase)

- AC-156, ATEX, c-UL-us, CE, RCM, RoHS, KCC, EAC, REACH, SEMI F47, Lloyd's Register, TUV-FS

- Normal duty application: 110% - 60 s, 150% - 3 s (For 20 Hp & above)
- Heavy duty application: 150% - 60 s, 180% - 3 s (200% - 3 secs programmable)

- 0...500 Hz

- 5 Digits, 16 segments QuickView™ LCD display with multiple languages and local keypad • Remote keypad
- MainsFree™ programming via USB • Application specific parameter group AppView™ and CustomView™
- Studio 5000 • Connected Components Workbench (CCW)

- Built-in EtherNet/IP Port
- Integral RS485 (Modbus RTU)
- Optional: Dual-port EtherNet/IP, DeviceNet, PROFIBUS DP

- Qty. 2 (1 bipolar voltage, 1 current)

- Qty. 1 (unipolar voltage or current)

- Qty. 1 (uses an analog input)

- Qty. 7 (24V DC, 6 programmable)

- Qty. 2 (1 form A Relay, 1 form B Relay)

- Qty. 2

- Internal IGBT

- Built-in Safe Torque Off, SIL2, PLd, CAT 3

- 41

PowerFlex 527 AC Drive

- Volts per Hertz • Sensorless vector control
- Closed loop velocity vector control

- Open loop speed regulation
- Closed loop speed regulation

• 0.4...1.1 kW • 0.5...1.5 Hp • 2.5...6 A

• 0.4...15 kW • 0.5...20 Hp • 2.5...62.1 A

• 0.4...22 kW • 0.5...30 Hp • 1.4...43 A

• 0.4...22 kW • 0.5...30 Hp • 0.9...32 A

- IP20: -20 to 50 °C (-4 to 122 °F)
- IP20 Zero Stacking: -20* to 45 °C (-4 to 113 °F)
- IP20: -20 to 70 °C (158 °F) with current derating and optional control module fan kit

- Internal (1 phase 240V and 3 phase 480V)
- External (1 & 3 phase)

- AC-156, ATEX, c-UL-us, CE, RCM, RoHS, KCC, EAC, REACH, SEMI F47, Lloyd's Register, TUV-FS, ODVA CIP/Safety

- Normal duty application: 110% - 60 secs, 150% - 3 s (For 20 Hp & above)
- Heavy duty application: 150% - 60 secs, 180% - 3 s (200% - 3 secs programmable)

- 0...590 Hz

- Studio 5000 Logix Designer

- Built-in dual-port EtherNet/IP

- Qty. 2 (1 bipolar voltage, 1 current)

- Qty. 1 (unipolar voltage or current)

- Qty. 1 (uses an analog input)

- Qty. 4 (24V DC, 3 programmable)

- Qty. 2 (1 form A Relay, 1 form B Relay)

- Qty. 2

- Internal IGBT

- Built-in Safe Torque Off, SIL 3, PLe, CAT 3
- Built-in Networked Safety SIL 3, PLe, CAT 3

- 45

PowerFlex AC and DC Drives

PowerFlex 70 AC Drive

PowerFlex 753 AC Drive

Motor Control	<ul style="list-style-type: none"> Flux vector control with and without an encoder Sensorless vector control • Volts per Hertz 	<ul style="list-style-type: none"> Flux vector control with and without an encoder Sensorless vector control • Volts per Hertz Permanent magnet motor control (interior only)
Application	<ul style="list-style-type: none"> Open loop speed regulation • Closed loop speed regulation Accurate torque and speed regulation 	<ul style="list-style-type: none"> Open loop speed regulation • Closed loop speed regulation Accurate torque and speed regulation • Indexer positioning
Single-phase Input with Derate	• Yes	• Yes
Ratings 200-240V	• 0.37...18.5 kW • 0.5...25 Hp • 2.2...70 A	• 0.37...132 kW • 0.5...200 Hp • 2.2...477 A
Ratings 400-480V	• 0.37...37 kW • 0.5...50 Hp • 1.1...72 A	• 0.75...270 kW • 1...400 Hp • 2.1...477 A
Ratings 500-600V	• 0.37...37 kW • 0.5...50 Hp • 0.9...52 A	• 1...300 Hp • 1.7...289 A
Ratings 690V	• N/A	• 7.5...250 kW • 12...263 A
Ambient Temperature Limit for Enclosure Types	<ul style="list-style-type: none"> IP20, NEMA/UL Type 1: 0 to 50 °C (32 to 122 °F) Flange mount: 0 to 50 °C (32 to 122 °F) IP66, NEMA/UL Type 4X/12 indoor: 0 to 40 °C (32 to 104 °F) 	<ul style="list-style-type: none"> IP00/IP20, NEMA/UL Open Type = 0-50 °C (32-122 °F)** NEMA/UL Type 1 Kit = 0-40 °C (32-104 °F) • Flange mount front: IP00/IP20, NEMA/UL Open Type = 0-50 °C (32-122 °F)** Flange mount back: IP66, NEMA/UL Type 4X = 0-40 °C (32-104 °F) IP54, NEMA/UL Type 12 = 0-40 °C (32-104 °F)
EMC Filters	• Internal	• Internally mounted option
Standards and Certifications	<ul style="list-style-type: none"> ABS, c-UL-us, CE*, EAC, KCC, Lloyd's Register, NSF Certified (IP66, NEMA/UL Type 4X/12 only), RCM*, RoHS, SEMI F47, AC-156, TUV FS, ABS, RINA 	<ul style="list-style-type: none"> ABS, c-UL-us, CE, EAC, KCC, Lloyd's Register, RCM, RoHS, SEMI F47, AC-156, TUV FS****, ABS, RINA, ATEX****
Overload Capability	<ul style="list-style-type: none"> Normal duty application: 110% - 60 s, 150% - 3 s Heavy duty application: 150% - 60 s, 200% - 3 s 	<ul style="list-style-type: none"> Normal duty application: 110% - 60 s, 150% - 3 s Heavy duty application: 150% - 60 s, 180% - 3 s
Output Frequency Range	• 0...500 Hz	<ul style="list-style-type: none"> 0...325 Hz @ 2 kHz PWM 0...590 Hz @ 4 kHz PWM****
User Interface	<ul style="list-style-type: none"> Local PowerFlex HIMs Remote PowerFlex HIMs Studio 5000 Software Connected Components Workbench Software 	<ul style="list-style-type: none"> Local PowerFlex HIMs Remote PowerFlex HIMs Studio 5000 Software Connected Components Workbench Software
Communications Options	<ul style="list-style-type: none"> Internal DPI • DeviceNet • ControlNet (Coax or Fiber) Single or Dual-port Ethernet/IP options RS485 DF1 • BACnet • RS485 HVAC (Modbus RTU, Metasys N2, Siemens P1) • PROFIBUS DP • Interbus External SCANport • Modbus/TCP • CANopen • LonWorks 	<ul style="list-style-type: none"> Single or Dual-port Ethernet/IP options • ControlNet (Coax or Fiber) • DeviceNet • RS485 DF1 PROFIBUS DP • BACnet/IP • Modbus/TCP • HVAC (Modbus RTU, FLN P1, Metasys N2) • ProfiNet IO LonWorks • CANopen
Conformal Coating	• Standard	• Standard
Analog Inputs	• Qty. 2 (1 bipolar voltage or current, 1 unipolar voltage or current)	• Up to 7 total (bipolar voltage or current)
Analog Outputs	• Qty. 1 (unipolar voltage or current)	• Up to 7 total (bipolar voltage or current)
PTC Inputs	• Qty. 1 (uses an analog input)	• Up to 3 total
Digital Inputs	• Qty. 6 (24V DC or 115V AC, option card required for 115V)	• Up to 21 total (Qty. 21 - 24V DC or Qty. 19 - 115V AC)
Relay Outputs	• Qty. 2 (form C)	• Up to 7 total
Transistor Outputs	• None	• Up to 7 total
Internal Brake Transistor	• Standard	• Standard (frames 1-5) Optional (frame 6-7)
AC Input Choke	• No	• No
DC Link Choke	• FR C-E Yes	• Yes
Common Mode Choke	• External option	• External option
Safety	• Hardwired Safe Torque Off SIL2, PLd, CAT 3 - option	<ul style="list-style-type: none"> Hardwired Safe Torque Off SIL3, PLe, CAT 3 - option Hardwired Safe Speed Monitor SIL3, PLe, CAT 4 - option
Found on Page	• 57	• 66

* CE certification testing has not been performed on 600V drives

** Frame 7, 477A Output, All Enclosures = 0-40 °C (32-104 °F)

*** Requires 11-Series I/O and ATEX daughter card options

**** Derating @4kHz; see technical specifications

***** Requires 20-750-50 or 20-750-51 card to be installed

PowerFlex 755 Wall Mount AC Drive

- Flux vector control with and without an encoder
- Sensorless vector control • Volts per Hertz
- Surface mount and interior permanent magnet motor control (with and without encoder) Frames 1 - 7
- Open loop speed regulation • Closed loop speed regulation • Accurate torque and speed regulation
- Accurate positioning with PCAM, indexer and gearing
- Yes
- 0.37...132 kW • 0.5...200 Hp • 2.2...477 A
- 0.75...270 kW • 1...400 Hp • 2.1...477 A
- 1...300 Hp • 1.7...289 A
- 7.5...250 kW • 12...263 A
- IP00/IP20, NEMA/UL Open Type = 0-50 °C (32-122 °F)**
- NEMA/UL Type 1 kit = 0-40 °C (32-104 °F) • Flange mount front: IP00/IP20, NEMA/UL Open Type = 0-50 °C (32-122 °F)**
- Flange mount back: IP66, NEMA/UL Type 4X = 0-40 °C (32-104 °F) • IP54, NEMA/UL Type 12 = 0-40 °C (32-104 °F)
- Internally mounted option
- ABS, c-UL-us, CE, EAC, KCC, Lloyd's Register, RCM, RoHS, SEMI F47, AC-156, TUV FS****, ABS, RINA, ATEX***
- Normal duty application: 110% - 60 s, 150% - 3 s
- Heavy duty application: 150% - 60s, 180% - 3 s
- 0...325 Hz @ 2 kHz PWM
- 0...590 Hz @ 4 kHz PWM****
- Local PowerFlex HIMs
- Remote PowerFlex HIMs
- Studio 5000 Software
- Connected Components Workbench Software
- Built-In EtherNet/IP port or Dual-port EtherNet/IP option module • ControlNet (coax or fiber)
- DeviceNet • BACnet/IP • RS485 DFI • PROFIBUS DP • Modbus/TCP • HVAC (Modbus RTU, FLN P1, Metasys N2) • ProfiNet IO
- LonWorks • CANopen
- Standard
- Up to 10 total (bipolar voltage or current)
- Up to 10 total (bipolar voltage or current)
- Up to 5 total
- Up to 31 total (24V DC or 115V AC)
- Up to 10 total (form C)
- Up to 10 total
- Standard (frames 1-5) Optional (frame 6-7)
- No
- Yes
- External option
- Hardwired Safe Torque Off SIL3, PLc, CAT 3 - option
- Networked Safe Torque Off SIL3, PLc, CAT 3 - option
- Hardwired Safe Speed Monitor SIL3, PLc, CAT 4 - option
- 82

PowerFlex 755 Floor Mount AC Drive

- Flux vector control with and without an encoder
- Sensorless vector control • Volts per Hertz
- Surface mount and interior permanent magnet motor control (with encoder)
- Open loop speed regulation • Closed loop speed regulation • Accurate torque and speed regulation
- Accurate positioning with PCAM, indexer and gearing
- No
- N/A
- 200...1400 kW • 300...2000 Hp • 370...2330 A
- 250...1500 Hp • 272...1530 A
- 200...1500 kW • 215...1485 A
- IP00/IP20, NEMA/UL Open Type = 0-40 °C (32-104 °F)
- IP54, NEMA/UL Type 12 = 0-40 °C (32-104 °F)
- Operation to 50 °C (122 °F) with derating
- Internally mounted option
- ABS, c-UL-us, CE, EAC, KCC, Lloyd's Register, RCM, RoHS, SEMI F47, AC-156, TUV FS****, ABS, RINA, ATEX***
- Normal duty application • 110% - 60 s, 150% - 3 s
- Heavy duty application • 150% - 60 s, 180% - 3 s
- Light duty application (frames 8-10) • 110% - 60 s
- 0...325 Hz @ 2 kHz PWM
- 0...590 Hz @ 4 kHz PWM****
- Local PowerFlex HIMs
- Optional door-mounted PowerFlex HIMs
- Studio 5000 Software
- Connected Components Workbench Software
- Built-in EtherNet/IP port or Dual-port EtherNet/IP option module • ControlNet (coax or fiber)
- DeviceNet • BACnet/IP • RS485 DFI • PROFIBUS DP • Modbus/TCP • HVAC (Modbus RTU, FLN P1, Metasys N2) • ProfiNet IO • LonWorks • CANopen
- Standard
- Up to 10 total (bipolar voltage or current)
- Up to 10 total (bipolar voltage or current)
- Up to 5 total
- Up to 31 total (24V DC or 115V AC)
- Up to 10 total (form C)
- Up to 10 total
- Frames 8-10 require external brake module
- No
- Yes
- External option
- Hardwired Safe Torque Off SIL3, PLc, CAT 3 - option
- Networked Safe Torque Off SIL3, PLc, CAT 3 - option
- Hardwired Safe Speed Monitor SIL3, PLc, CAT 4 - option
- 82

PowerFlex DC Drive

Motor Control	<ul style="list-style-type: none"> • Regenerative and Non-regenerative • Field weakening and Economize
Application Performance	<ul style="list-style-type: none"> • Open loop speed regulation • Closed loop speed regulation • Accurate torque regulation
Single-phase Input with Derate	<ul style="list-style-type: none"> • N/A
Ratings 200-240V	<ul style="list-style-type: none"> • 1.2...224 kW • 1.5...300 Hp • 7...1050 A
Ratings 400-480V	<ul style="list-style-type: none"> • 1.5...671 kW • 2...900 Hp • 4.1...1494 A
Ratings 500-600V	<ul style="list-style-type: none"> • 37...932 kW/50...1250 Hp/67.5...1688 A
Ratings 690V	<ul style="list-style-type: none"> • 298...1044 kW/400...1400 Hp/452...1582 A
Ambient Temperature Limit for Enclosure Types	<ul style="list-style-type: none"> • IP 20 / Open = 50 °C (104 °F) • 55 °C (131 °F) with derating
EMC Filters	<ul style="list-style-type: none"> • External
Standards and Certifications	<ul style="list-style-type: none"> • c-UL-us, CE, EAC, KCC, RCM, RoHS
Overload Capability	<ul style="list-style-type: none"> • Heavy Duty Application: 150% - 60 s, 200% - 3 s
Output Speed Range	<ul style="list-style-type: none"> • 1000:1 DC Tach • 100:1 Armature feedback • 1000:1 Digital Incremental Encoder/Resolver
User Interface	<ul style="list-style-type: none"> • Local PowerFlex HIMs • Remote PowerFlex HIMs • Studio 5000 Software • Connected Components Workbench Software
Communications Options	<ul style="list-style-type: none"> • Internal DPI • Options: single or dual-port EtherNet/IP, ControlNet, DeviceNet, BACNet, HVAC comm adapter, Modbus, PROFIBUS DP
Conformal Coating	<ul style="list-style-type: none"> • Standard
Preset Speeds	<ul style="list-style-type: none"> • 7
Standard Analog Inputs	<ul style="list-style-type: none"> • 3 - Configurable (13 bit + sign, each ±V or mA)
Standard Digital Inputs	<ul style="list-style-type: none"> • 8 - Configurable (24V DC)
Standard Analog Outputs	<ul style="list-style-type: none"> • 2 - Configurable (11-Bit + sign, each ±V)
Standard Digital Outputs	<ul style="list-style-type: none"> • 4 - Configurable (24V DC) • 2 - Configurable Relay (NO)
Dynamic Braking	<ul style="list-style-type: none"> • Armature Regen or Dynamic Braking Resistor
Safety	<ul style="list-style-type: none"> • No
Found on Page	<ul style="list-style-type: none"> • 148

PowerFlex AC Drives

	PowerFlex 755TL AC Drive	PowerFlex 755TR AC Drive	PowerFlex 755TM AC Drive
TotalFORCE Technology Motor Control	<ul style="list-style-type: none"> Flux Vector Control • Sensorless vector Volts per Hertz • Economizer Field oriented control 	<ul style="list-style-type: none"> Flux Vector Control • Sensorless vector Volts per Hertz • Economizer Field oriented control 	<ul style="list-style-type: none"> Flux Vector Control • Sensorless vector Volts per Hertz • Economizer Field oriented control
Application	<ul style="list-style-type: none"> Open loop speed regulation • Closed loop speed regulation • Precise torque and speed regulation • Indexer positioning 	<ul style="list-style-type: none"> Open loop speed regulation • Closed loop speed regulation • Precise torque and speed regulation • Indexer positioning 	<ul style="list-style-type: none"> Open loop speed regulation • Closed loop speed regulation • Precise torque and speed regulation • Indexer positioning
Single-phase Input w/Derate	• No	• No	• No
Ratings 200-240V	• N/A	• N/A	• N/A
Ratings 400-480V	<ul style="list-style-type: none"> 160...1250 kW (302...2156 A) @ 400V 250...1800 Hp (302...2072 A) @ 480V 	<ul style="list-style-type: none"> 160...2000 kW (302...3542 A) @400V 250...3000 Hp (302...3404 A) @480V 	<ul style="list-style-type: none"> Common Bus Inverter: 160...2000 kW (302...3542 A) @400V / 250...3000 Hp (302...3404 A) @480V Regenerative Bus Supplies: 188...2204 kW (324...3801 A) @400V / 216...2436 kW (311...3501 A) @480V
Ratings 500-600V	• 250...1500 Hp (242...1430 A) @ 600V	• 250...2500 Hp (242...2420 A) @ 600V	<ul style="list-style-type: none"> Common Bus Inverter: 250...2500 Hp (242...2420 A) @ 600V Regenerative Bus: 217...2164 kW (249...2489 A) @ 600V
Ratings 690V	• 200...1400 kW (215...1419 A) @ 690V	• 200...2300 kW (215...2318 A) @ 690V	<ul style="list-style-type: none"> Common Bus Inverter: 200...2300 kW (215...2318 A) @ 690V Regenerative Bus Supplies: 221...2379 kW (221...2379 A) @ 690V
Ambient Temperature Limit for Enclosure Types	<ul style="list-style-type: none"> -20...40 °C -20...55 °C with derate 	<ul style="list-style-type: none"> -20...40 °C -20...55 °C with derate 	<ul style="list-style-type: none"> -20...40 °C -20...55 °C with derate
EMC Filters	• Internally mounted option	• Internally mounted option	• Internally mounted option
Standards and Certifications	<ul style="list-style-type: none"> ABS, AC156 Seismic Standards, ATEX, CAN/CSA, CE Mark, DNV, EAC Mark, IEC60721-3-3, ISA 71.04-1985, KCC, Lloyd's Register, ODVA EtherNet/IP, RCM, SEMI F47, UkrSepro Mark, UL61800-5-1 (cULus) 	<ul style="list-style-type: none"> ABS, AC156 Seismic Standards, ATEX, CAN/CSA, CE Mark, DNV, EAC Mark, IEC60721-3-3, ISA 71.04-1985, KCC, Lloyd's Register, ODVA EtherNet/IP, RCM, SEMI F47, UkrSepro Mark, UL61800-5-1 (cULus) 	<ul style="list-style-type: none"> ABS, AC156 Seismic Standards, ATEX, CAN/CSA, CE Mark, DNV, EAC Mark, IEC60721-3-3, ISA 71.04-1985, KCC, Lloyd's Register, ODVA EtherNet/IP, RCM, SEMI F47, UkrSepro Mark, UL61800-5-1 (cULus)
Overload Capability	<ul style="list-style-type: none"> Normal duty: 110% - 60 s, 150% - 3 s Heavy duty: 150% - 60 s, 180% - 3 s Light duty: 110% - 60 s 	<ul style="list-style-type: none"> Normal duty: 110% - 60 s, 150% - 3 s Heavy duty: 150% - 60 s, 180% - 3 s Light duty: 110% - 60 s 	<ul style="list-style-type: none"> Normal duty: 110% - 60 s, 150% - 3 s Heavy duty: 150% - 60 s, 180% - 3 s Light duty: 110% - 60 s
Output Frequency Range	<ul style="list-style-type: none"> 0...325 Hz @ 1.33 kHz carrier 0...325 Hz @ 2 kHz carrier 0...590 Hz @ 4 kHz carrier 	<ul style="list-style-type: none"> 0...325 Hz @ 1.33 kHz carrier 0...325 Hz @ 2 kHz carrier 0...590 Hz @ 4 kHz carrier 	<ul style="list-style-type: none"> 0...325 Hz @ 1.33 kHz carrier 0...325 Hz @ 2 kHz carrier 0...590 Hz @ 4 kHz carrier
User Interface	<ul style="list-style-type: none"> Local PowerFlex HIMs Remote PowerFlex HIMs Studio 5000 Software Connected Components Workbench Software 	<ul style="list-style-type: none"> Local PowerFlex HIMs Remote PowerFlex HIMs Studio 5000 Software Connected Components Workbench Software 	<ul style="list-style-type: none"> Local PowerFlex HIMs Remote PowerFlex HIMs Studio 5000 Software Connected Components Workbench Software
Communications Options	<ul style="list-style-type: none"> Internal DPI Built-in dual EtherNet/IP ports Options: ControlNet, DeviceNet, PROFIBUS DP, PROFINET 	<ul style="list-style-type: none"> Internal DPI Built-in dual EtherNet/IP ports Options: ControlNet, DeviceNet, PROFIBUS DP, PROFINET 	<ul style="list-style-type: none"> Internal DPI Built-in dual EtherNet/IP ports Options: ControlNet, DeviceNet, PROFIBUS DP, PROFINET
Conformal Coating	• Standard	• Standard	• Standard
Analog Inputs	• Up to 10 total	• Up to 10 total	• Up to 10 total
Analog Outputs	• Up to 10 total	• Up to 10 total	• Up to 10 total
PTC Inputs	• Up to 5 total	• Up to 5 total	• Up to 5 total
Digital Inputs	• Up to 31 total	• Up to 31 total	• Up to 31 total
Relay Outputs	• Up to 10 total	• Up to 10 total	• Up to 10 total
Transistor Outputs	• Up to 10 total	• Up to 10 total	• Up to 10 total
Internal Brake Transistor	• No	• No	• No
AC Input Choke	• No	• No	• No
DC Link Choke	• Yes	• Yes	• Yes
Common Mode Choke	• Optional accessory	• Optional accessory	• Optional accessory
Safety	<ul style="list-style-type: none"> Hardwired Safe Torque Off SIL3 PLe, CAT 3 Networked Safe Torque Off SIL3 PLe, CAT 3 Hardwired Safe Speed Monitor SIL3, PLe, CAT 4 	<ul style="list-style-type: none"> Hardwired Safe Torque Off SIL3 PLe, CAT 3 Networked Safe Torque Off SIL3 PLe, CAT 3 Hardwired Safe Speed Monitor SIL3, PLe, CAT 4 	<ul style="list-style-type: none"> Hardwired Safe Torque Off SIL3 PLe, CAT 3 Networked Safe Torque Off SIL3 PLe, CAT 3 Hardwired Safe Speed Monitor SIL3, PLe, CAT 4
Found on Page	• 118	• 118	• See Common DC Bus Selection Guide, pub DRIVES-SG001

This glossary of terms provides more detailed explanations of the phrases and technologies referenced in this selection guide.

Adaptive Control	<p>PowerFlex Drives with TotalForce technology continuously monitor the application and automatically adjust for optimal system performance.</p> <p>As your equipment operates, load observer and adaptive tuning monitor the variables that can change over time and automatically make adjustments to compensate for the mechanical changes that occur, which includes load dynamics and high frequency resonances. Together, load observer and adaptive tuning help to reduce commissioning time and mechanical wear while improving the performance of most applications.</p>
AppView®	<p>This feature of the PowerFlex® 523 and 525 drives provides parameter groups for several of the most common applications, including conveyors, mixers, compressors, pumps, and blowers. With the settings to run these applications already in place, you can get your machine up and running faster, helping to increase productivity.</p>
Connected Components Workbench™ software	<p>Connected Components Workbench software is a set of collaborative tools supporting the Guardmaster® Configurable Safety Relay, Micro800™ controllers, PowerFlex drives and PanelView™ component operator interface products. It is based on proven Rockwell Automation and Microsoft Visual Studio technology and offers controller programming, device configuration and integration with HIM editor. Program your controllers, configure your devices, and design your operator interface screens using this software and help minimize your initial machine development with this free software.</p>
CustomView™	<p>Customize your machine and help reduce future design and development time by quickly defining your own group of parameters. AppView and CustomView tools are both available for use with the PowerFlex 523 and 525 drives through the integral HIM, Connected Components Workbench software, and the Studio 5000 Logix Designer® application.</p>
DeviceLogix™	<p>This technology for the PowerFlex 753 and 755 drives lets you control outputs and manage status information locally within the drive, allowing you to operate the drive independently or complementary to supervisory control to help improve system performance and productivity. With DeviceLogix, you can speed reaction time by processing in the drive which reduces dependency on network throughput.</p>
FORCE Technology	<p>This Allen-Bradley patented Field Oriented Control is a version of Flux Vector Control. It provides excellent low speed/zero speed performance and delivers accurate torque and speed regulation.</p>
MainsFree™	<p>A feature of PowerFlex 523 and 525 drives where you can connect your control module to a personal computer with a standard USB cable and quick upload, download, and flash the drive with new settings.</p>
QuickView™	<p>A feature of PowerFlex 523 and 525 drives where the dynamic LCD HIM supports multiple languages and features descriptive QuickView scrolling text.</p>
Premier Integration	<p>This is the exclusive experience of integrating Allen-Bradley motor control devices into the Allen-Bradley Logix control platform. Use just one software tool to help reduce your programming time, ease startup and commissioning and streamline diagnostics. To learn more, refer to the Premier Integration white paper, publication IMCPI-WP001.</p>

Pump Off	This unique feature specific for oil well applications is a patented pump-off function that measures the torque and currents on a motor to determine flow from a well. This alternative to traditional mechanical flow meters allows pump operators to optimize production based on the flow of the well and can also help reduce downtime by protecting the rod and motor assets. Learn more about this feature for the PowerFlex 753 and 755 drives at PFLEX-AP004 .
Safe Speed Monitor	Provides a solution for applications using PowerFlex 750-Series or PowerFlex 755TL/755TR/755TM drives that can benefit from access to a safety zone while there is limited motion. In addition, Safe Speed Monitor has an integrated monitoring relay to save additional panel space and installation labor. This option carries a safety rating up to and including PLe/SIL3 and Cat 4. The Safe Speed Monitor option helps you safely monitor and control the speed of your application, which allows operators to perform process or maintenance work without stopping the machine.
Safe Torque Off	PowerFlex 70 and 753 AC drives are available with optional Safe Torque Off functionality offering Safe-off control. Safe Torque Off is a standard built-in feature on the PowerFlex 525 AC drive. And the PowerFlex 527, 755, 755TL, 755TR and 755TM drives provide a choice for Safe Torque Off implementation. They offer hardwired Safe Torque Off as well as the option of Networked Safety, a controller-based safety function that is configured in the Studio 5000 Logix Designer environment and delivered via EtherNet/IP.
TotalFORCE™ Technology	PowerFlex 755TL/755TR/755TM drives are the first to offer TotalFORCE technology. This new drive technology is the evolution of the Allen-Bradley variable speed control platform. It delivers precise, responsive control of position, velocity and torque for electric motors and incorporates several patented features that are designed to help optimize your system and maintain productivity. Features of TotalFORCE Technology include: <ul style="list-style-type: none">• Concurrent and independent control of flux and torque• High bandwidth motor control• High performance torque smoothness and accuracy• Supports multiple motor types
TorqProve™	This feature helps verify control of the load in crane and hoisting applications. TorqProve helps alleviate concerns with brake timing and environmental changes and can significantly reduce wear and tear on the mechanical brake with smooth operation and reduced machine stress. This standard feature is available in PowerFlex 755, 755TL, 755TR and 755TM AC drives, PowerFlex DC drives and as a control option for PowerFlex 7000 medium voltage drives.

Line & Load Options

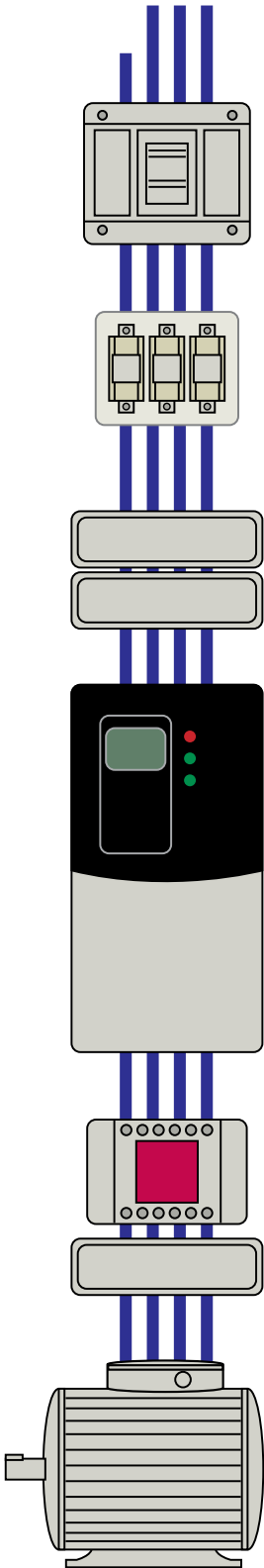

AC supply source

Input line reactor recommended when line voltage imbalances are greater than 2%.

Input Fusing and Circuit Breakers

The recommended fuse types are listed in the product user manuals.

Rockwell Automation offers a full line of Allen-Bradley® circuit breakers and motor protection devices to help meet many of your application needs.

Line reactor

Needs to be applied if:

- a) Installation site has switched power factor correction capacitors
- b) Installation site has power interruptions or voltage dips
- c) The transformer is too large in comparison to the drive ([Refer to publication: DRIVES-IN001](#)).

Input filter

Compact PowerFlex drives: External EMC filter required for EMC compliance. With PowerFlex 523, 525 and 527 AC drives, EMC filtering is embedded at 200V and 400V. Architecture drives: External EMC filter only required with long motor cables and/or specific immunity requirements.

AC drive

Normal duty (ND) rating: 110% overload for 1 minute and 150% overload for 3 seconds. No excessive starting overload, transient overload or high duty cycle. The majority of typical AC drive applications are ND.

Heavy duty (HD) rating: 150% overload for 1 minute and 180% overload for 3 seconds. Required for high starting torque (e.g., heavily loaded conveyors), high brake-away torque (e.g., extruders and mixers) and high running torque (e.g., reciprocating compressors).

Output device or cable termination

Required if motor cable lengths exceed stated values ([Refer to publication: DRIVES-IN001](#)).

AC motor

Why Choose Allen-Bradley?

Get The Right Components, At The Right Price, Right When You Need Them

You'll find the highest-quality Essential Components at a fair price, an intuitive product selection, and fast delivery. The wide breadth of our component offering fits most applications so you do not pay for more than you need. Additionally, you will get components that perform to your specifications, with the services and support you demand. Refer to the Essential Components Catalog, publication [EG-CA100 -EN-P](#) to learn more.



Tools & Resources

Product Selection Toolbox

The Product Selection Toolbox is a collection of product selection and system design software tools that help you select Allen-Bradley products and design application solutions using those products.

From this tool you can create a single bill of material for the complete range of Allen-Bradley products; configure Motor Control Bus Systems, Motor Control Centers, Automation Systems, and Motion Control Systems; and create project bids and submittal documents.

Product Selection

- Drive Selector Wizard in ProposalWorks™ – Select a Low Voltage Drive
- Integrated Architecture Builder – Configure Automation Systems
- CenterONE® – Design Low Voltage Motor Control Centers
- MCS™ Star – Design Modular Motor Control Systems

System Design and Support Tools

- eCADWorks – Get CAD Drawings
- MotionAnalyzer – Design tool for speed and positioning applications
- RailBuilder™ – Design DIN Mountable Systems

Download the tools at:

<http://www.rockwellautomation.com/en/e-tools/>

Motion Analyzer

Motion Analyzer software helps machine builders by making it faster and easier to analyze, optimize, and select motion and drive control systems. A cloud-based architecture and a wide range of tools and features help users find the right set of products for their application.

Download the tool at:

<https://motionanalyzer.rockwellautomation.com>

Energy Savings Calculators

See how installing a PowerFlex drive for your fan or pump applications can reduce energy costs when compared with a traditional flow control method.

Download the tools at:

<http://www.rockwellenergycalc.com>

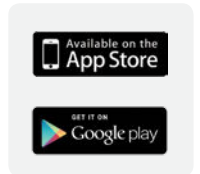

Drives and Motion Accelerator Toolkit

This collection of design tools can help you significantly reduce the time and cost of developing a new application using Allen-Bradley equipment, especially PowerFlex AC Drives and Kinetix Servo Drives.



The toolkit includes the powerful System Development Wizard which takes system data entered by the designer and automatically generates the files you need to jumpstart your design, including:

- Custom Bill Of Material
- Custom set of CAD drawings
- Logic program for the specific controller, drives and names used in the application
- Custom set of instructions to quickly adapt a starting HMI application

Information is delivered in a modular format.

- Module provides control and information for individual product or function
- Selecting specific modules allows you to tailor the application
- Modules are designed to interact in standard understandable and usable ways
- Selects the specific modules needed for the application
- Selected modules are combined, using standard design tools, to build starting BOM, CAD, Logic and HMI application files

Download the tool at: www.ab.com/go/iatools

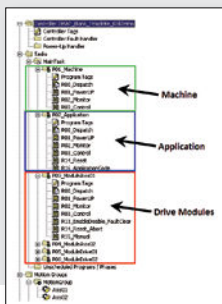

Rockwell Automation Services

We understand your need to capture and use production information, reduce downtime, improve safety, increase productivity and perform diagnostics—because they're our goals too.

Rockwell Automation can help you improve the performance of your people and maximize your automation investment with services like:

Start-up and Commissioning

- We can help you commission and start-up your new Allen-Bradley drive or system, and in turn, reduce the time between integration and actual start-up
- Our standard process validates that the necessary electrical, mechanical and environmental criteria have been met and the appropriate steps have been taken to ensure proper equipment operation
- Our highly experienced Field Service Professionals work with you to:
 - Help ensure on-time production
 - Improve equipment operation
 - Reduce risk of performance problems and premature equipment failures
 - Reduce total maintenance costs

Parts Management Agreement (PMA)

- Provides quick access to Rockwell Automation spare parts
- Reduces operating costs to maintain and manage inventory
- We own and manage your spare parts inventory for a fixed monthly or quarterly cost

Drives Training Curriculum

- Maximize job and automation asset performance through skill-building courses that introduce concepts and techniques to help properly wire drives and diagnose specific faults
- Exercises offer extensive hands-on practice using the drive

Safety Services

- Meet industry and global safety compliance regulations
- Rockwell Automation Machine Safety Consultants can perform any safety assessment and can assist at any step of a safeguarding project



Preventive Maintenance

- Regularly scheduled maintenance for your automation and related equipment to prevent potential problems and help extend component and system life
- Your preventive maintenance program provides the following and much more:
 - Full-service warranty
 - 24/7 remote troubleshooting
 - Fully warranted remanufactured replacement parts to ensure compatibility

Remanufacturing Services

- Remanufacturing and Exchange Services go far beyond other repair services with a comprehensive remanufacturing process that restores failed Allen-Bradley® and Reliance Electric™ equipment to its original operating condition to make sure it will function reliably

Online & Phone Support

- TechConnectSM Support provides unlimited, real-time access to our technical support engineers
- Rockwell Automation Knowledgebase is the online resource for technical information, assistance, technical notes, software updates, product/service e-mail notifications, and more

Assurance™ Integrated Support

- An annual guaranteed support agreement helps keep your systems running by combining remote support, replacement parts and on-site service into one comprehensive agreement, for one flat fee
- Minimize equipment downtime, eliminate unplanned repair expenses, ease staffing burdens and lower the total lifecycle cost of your assets

For more information, visit: www.rockwellautomation.com/global/go/services

Notes

Notes

Notes

Rockwell Automation Services

Global Support. Local Address. Peace of Mind.





Providing the resources you need, when and where you need them, Rockwell Automation has an integrated, global network of ISO-certified repair centers, exchange hubs, field service professionals, IACET-recognized training centers, certified technical phone support centers and online tools.

www.rockwellautomation.com/global/go/services

Meet Your Everyday Technical Needs

Remote Support & Monitoring	Training Services	OnSite Services	Repair Services
<ul style="list-style-type: none"> Real-time product, system and application-level support Unlimited online resources and tools Live chat and support forums Secure equipment monitoring, alarming and diagnostics 	<ul style="list-style-type: none"> Instructor-led and computer or web-based courses Virtual classroom Training assessments Workstations and job aids 	<ul style="list-style-type: none"> Embedded engineering Preventive maintenance Migrations and conversions Start-up and commissioning 	<ul style="list-style-type: none"> Product remanufacturing Repair services on a full range of industrial automation brands and products 

Maximize Your Automation Investment

MRO Demand Management	Lifecycle Extension & Migrations	Network & Security Services	Safety Services
<ul style="list-style-type: none"> Comprehensive asset management planning Reliability services Warranty tracking Quick access to global spare parts inventory 	<ul style="list-style-type: none"> Installed Base Evaluation™ Pinpoint obsolescence risk Tools and lifecycle support service agreements to mitigate production risk 	<ul style="list-style-type: none"> Control system lifecycle services Manage network convergence Security technology, policies and procedures services 	<ul style="list-style-type: none"> Safety assessments and remediation Safety design, integration and validation services 

Visit the Rockwell Automation Support Center at www.rockwellautomation.com/knowledgebase for technical information and assistance, plus:

- View technical/application notes
- Obtain software patches
- Subscribe for product/service email notifications
- Submit a Question, Live Chat, Support Forums and more

Visit Get Support Now at www.rockwellautomation.com/go/support to select your country and find your local support information.

 Connect with us.

Allen-Bradley, AppView, ArmorBlock, Assurance Integrated Support, CENTERLINE, CenterONE, CompactLogix, Connected Components Workbench, CustomView, DeviceLogix, FORCE Technology, GuardLogix, Guardmaster, Integrated Architecture, Kinetix, MainsFree programming, Micro800, PanelView, POINT I/O, PowerFlex, ProposalWorks, QuickView, RailBuilder, SensaGuard, Stratix, Studio 5000, Studio 5000 Logix Designer, TechConnect, TorqProve, TotalForce and Zero-Stacking Drives are trademarks of Rockwell Automation. Trademarks not belonging to Rockwell Automation are property of their respective companies.

www.rockwellautomation.com

Power, Control and Information Solutions Headquarters

Americas: Rockwell Automation, 1201 South Second Street, Milwaukee, WI 53204-2496 USA, Tel: (1) 414.382.2000, Fax: (1) 414.382.4444

Europe/Middle East/Africa: Rockwell Automation NV, Pegasus Park, De Kleetlaan 12a, 1831 Diegem, Belgium, Tel: (32) 2 663 0600, Fax: (32) 2 663 0640

Asia Pacific: Rockwell Automation, Level 14, Core F, Cyberport 3, 100 Cyberport Road, Hong Kong, Tel: (852) 2887 4788, Fax: (852) 2508 1846